

Parts List:

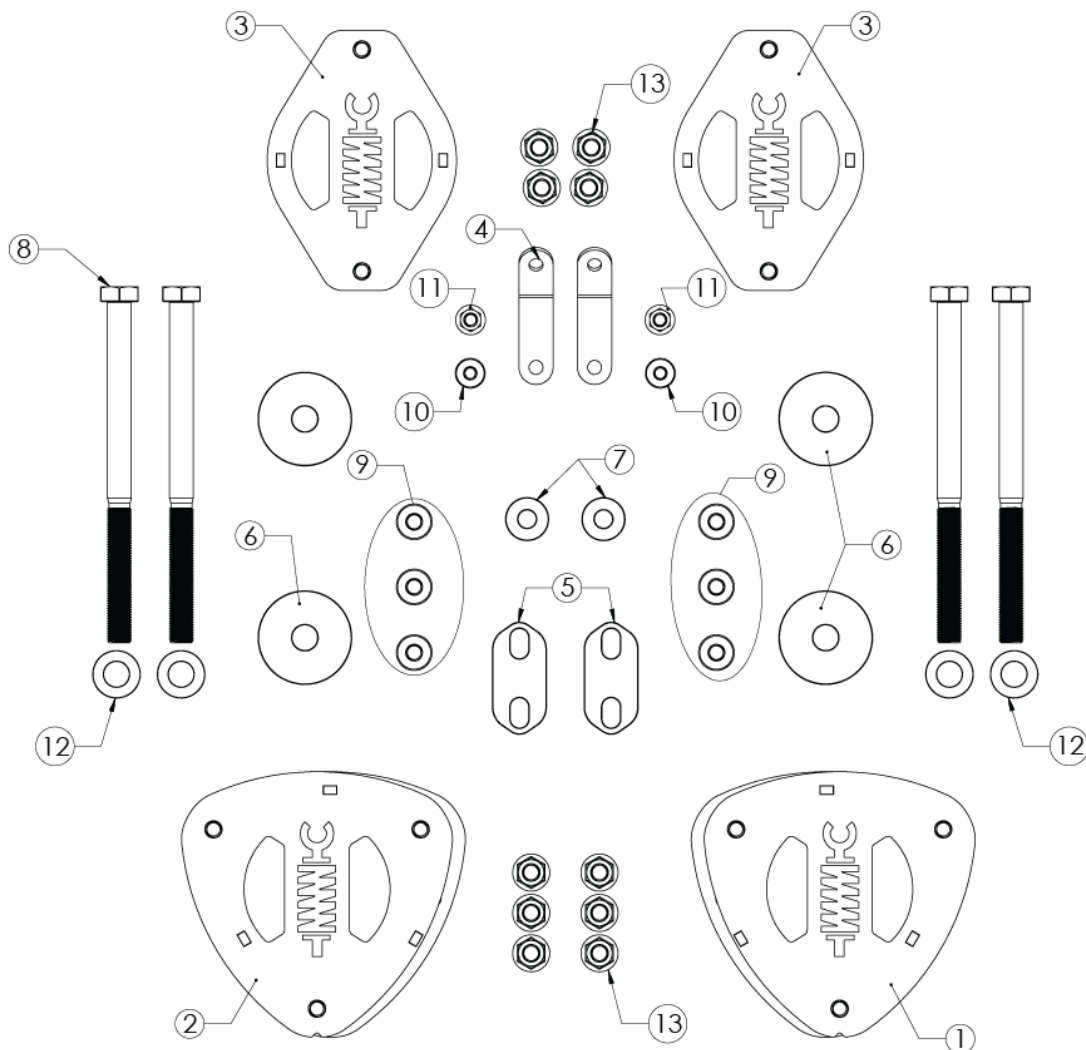
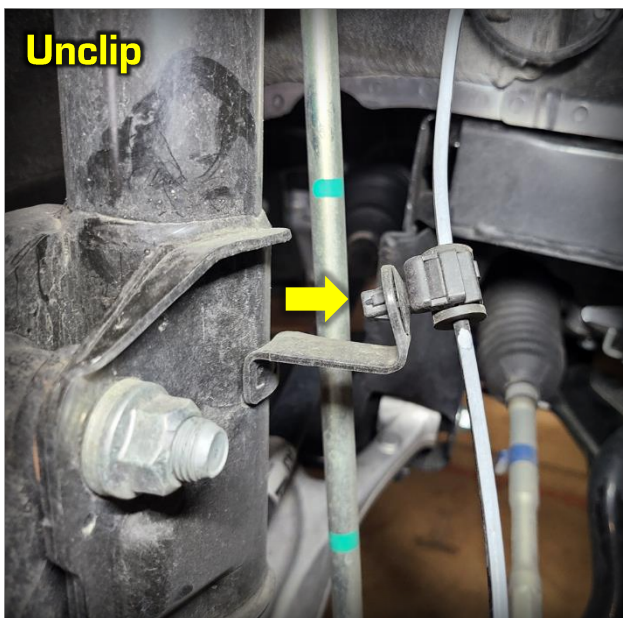
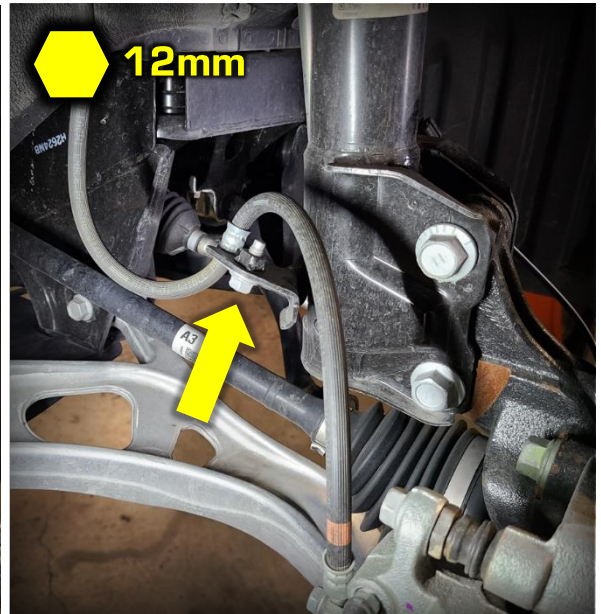
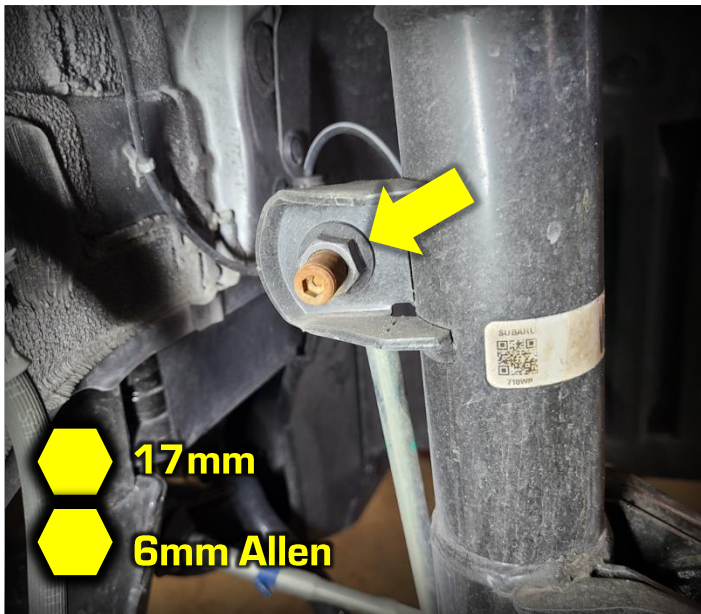

Diagram #	Part #	Description	Qty.
1	00P-OP2660LR	S/A Spacer, LF Strut Subaru 2" Red	1
2	00P-OP2660RR	S/A Spacer, RT Strut Subaru 2" Red	1
3	00P-OP2661-R	S/A Spacer, Rear Subaru 2" Red	2
4	00P-OP2684-B	Tab, Brake Line Extension Subaru	2
5	00P-OP2662-B	Spacer, Subframe Front, Subaru	2
6	00P-OP2663-B	Spacer, Subframe Main, Subaru	2
7	00P-OP2664-B	Spacer, Subframe Rear, Subaru	2
8	00P-OC1760-A	Bolt, M14-1.5x200mm	4
9	00P-OC1761-A	Bolt, M10-1.25x60mm Hex Flange	6
10	00P-OC1762-A	Bolt, M8-1.25x20mm Hex Flange	2
11	00P-OC1763-A	Nut, M8-1.25 Flange Nylock	2
12	00P-OC1232-A	Washer, Flat: M14, Zn Plt	4
13	81052	Nut, M10-1.5, Flanged Nylock, Class 10	10

Front Lift Installation:

- 1F Raise the vehicle with a 2-post lift (preferable), or floor jack. If using a floor jack, place jack stands in the factory designated jack points. Remove front wheels.
- 2F Unbolt the sway bar end link and brake line from strut. Unclip ABS line clip from strut and unbolt the sensor from the upright. (RT side shown)



3F Unbolt the (2) bolts and nuts holding the strut to the upright.

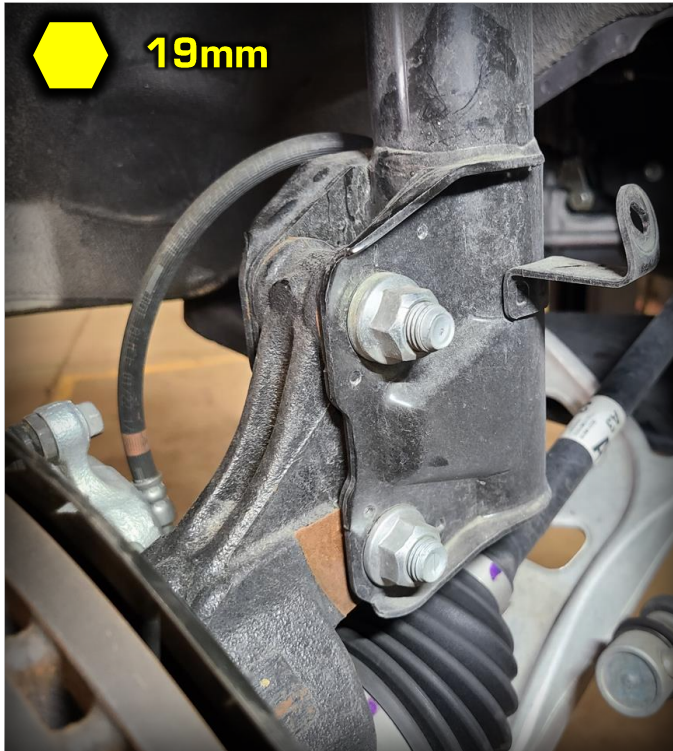

5F Open the hood and undo the (3) strut tower nuts and remove the strut from the vehicle.



6F Refer to the diagram below to determine which strut spacer you need to use on the side you are working on. The notch on top plate indicates points toward FRONT of the car.

Passenger Side (RT)

Driver Side (LF)

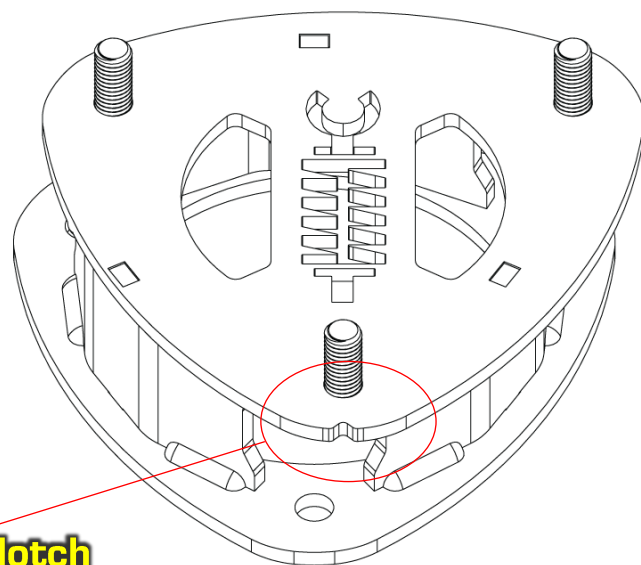
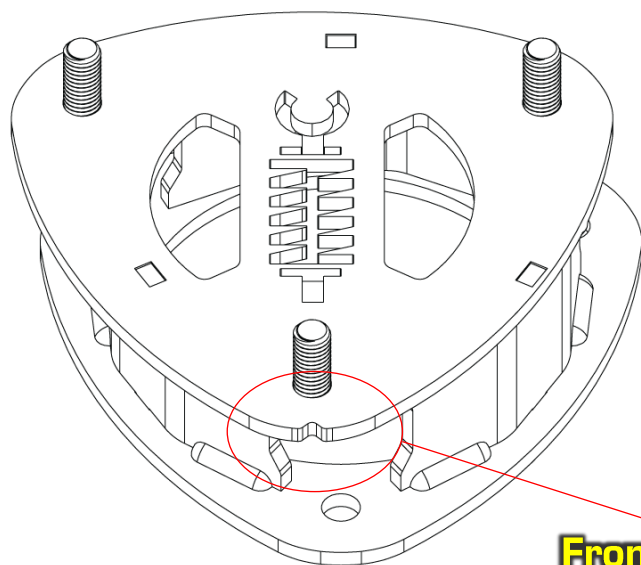

**Front Notch
Points Toward the
Front**

Passenger Side (RT)

Driver Side (LF)

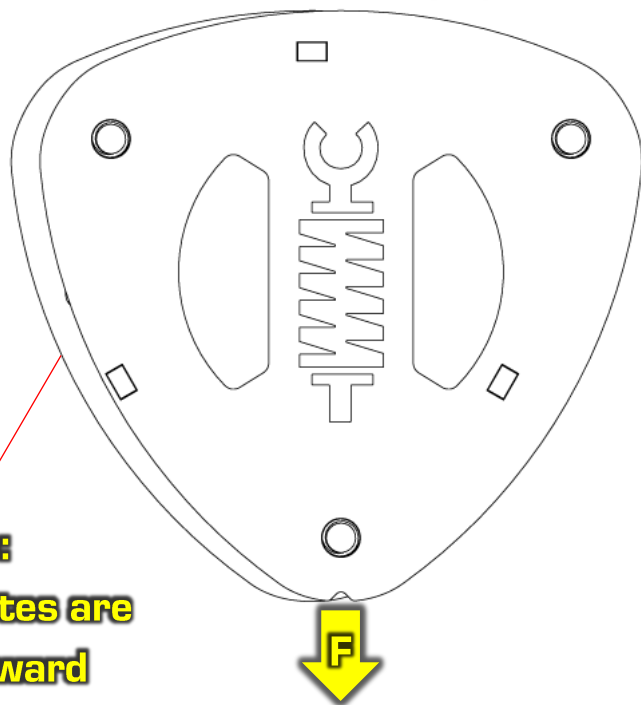
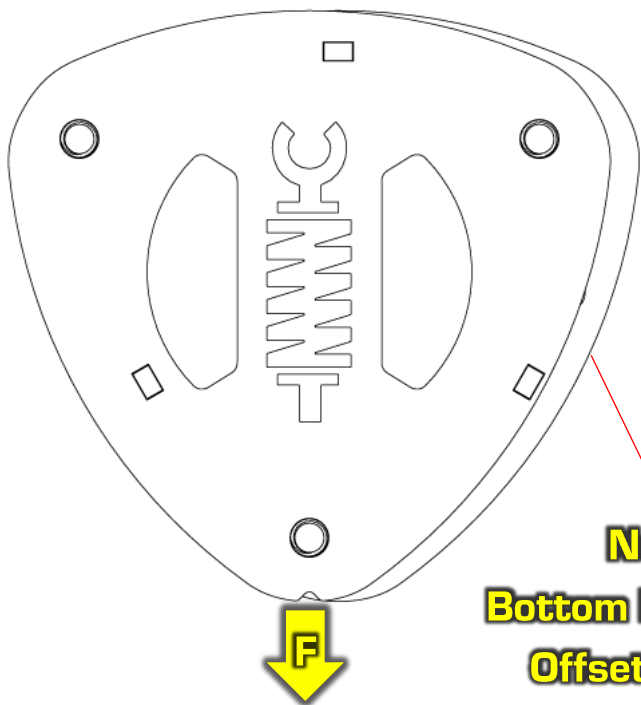

**Note:
Bottom Plates are
Offset Inward**

- 7F Place the aFe strut spacer on top of the strut top and tighten them together using the factory nuts.

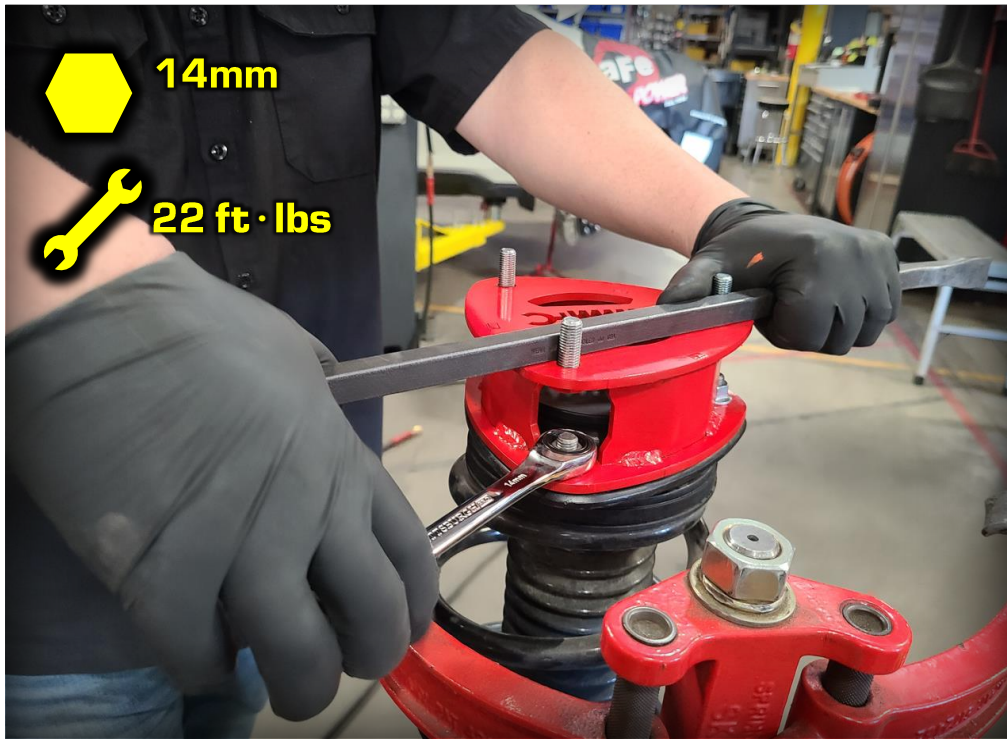

- 8F Reinstall the strut assembly back into the vehicle in reverse order.



Make sure to use the supplied aFe flange nuts for the top mounts.

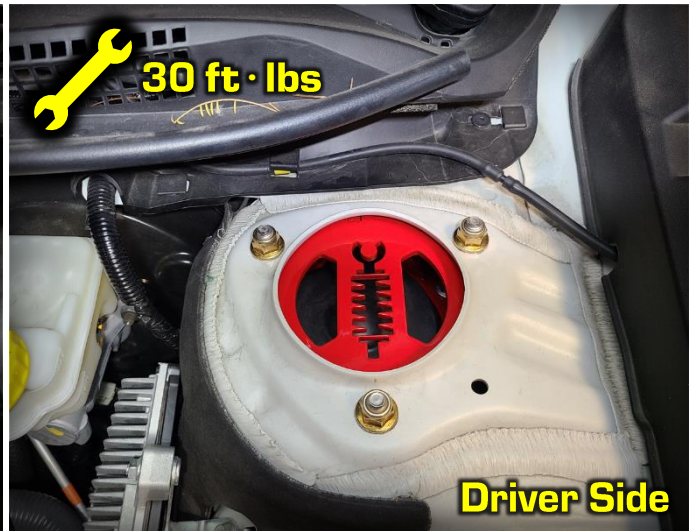
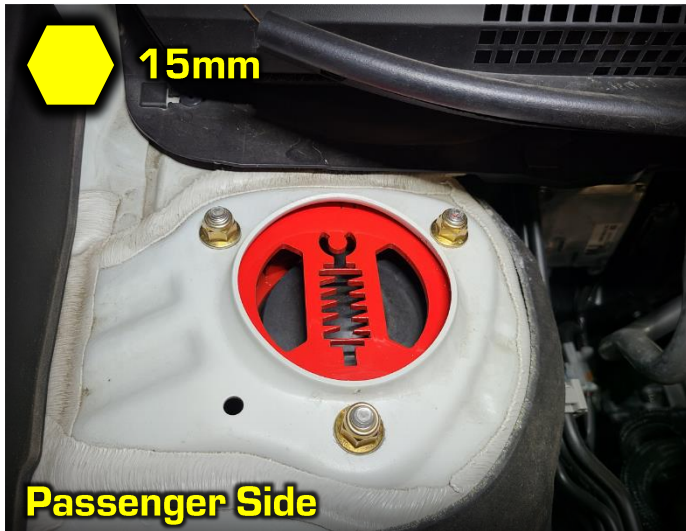

9F **Important:** When tightening the strut/upright bolts you must adjust the top bolt to full negative camber. In addition, you will need an assistant to help push the top of the rotor inward when tightening the strut. Reattach everything in Step 2F. Reinstall wheels. Move onto rear installation.



Push Top of Rotor Inward while Tightening Strut Bolts

Reattach:
Sway Bar End Link: 44 ft·lbs
Brake Line Tab: 22 ft·lbs
ABS Sensor: 14 ft·lbs

Rear Lift Installation:

- 1R Raise the vehicle with a 2-post lift (preferable), or floor jack. If using a floor jack, place jack stands in the factory designated jack points. Remove the rear wheels.
- 2R We will be removing the rear shock assembly by first unbolting the sway bar end link, lower shock mount and the outboard lower control arm bolt.

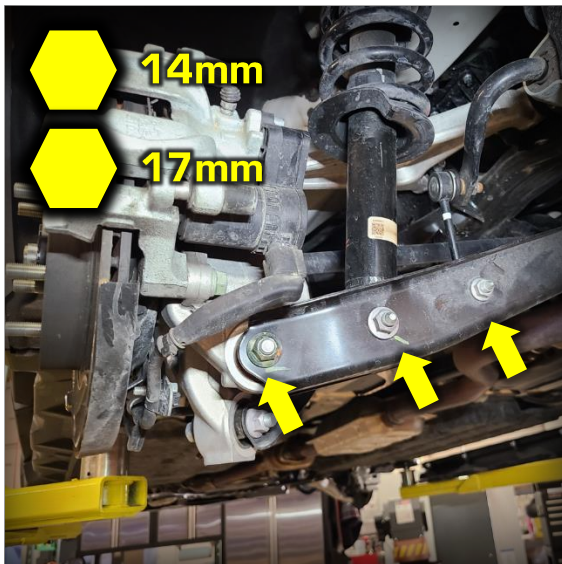

Next, open the hatch and locate the shock nuts underneath the side panels. Unbolt the top shock nuts.



Remove the shock assembly from the vehicle.

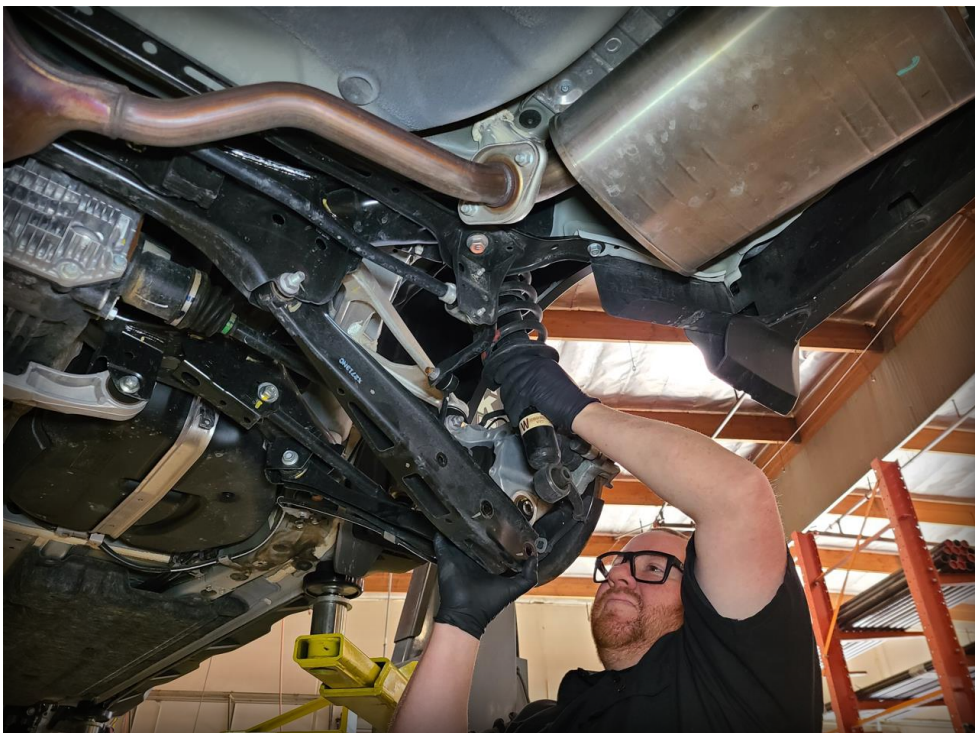

- 4R Place the aFe shock spacer on top of the shock assembly. Rotational orientation of the spacer does not matter. Use the factory shock nuts to secure the spacer to the shock assembly.

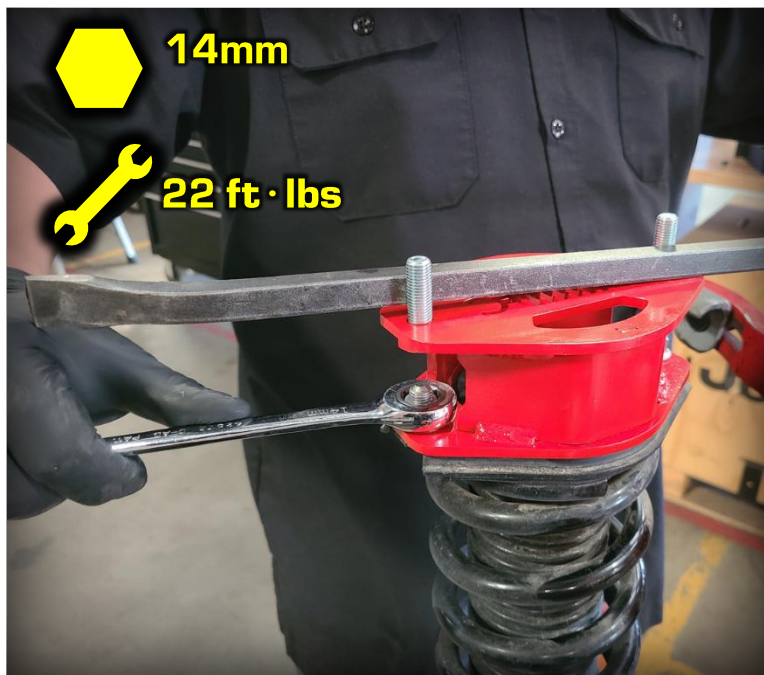

 14mm

 22 ft · lbs

5R Before we reinstall the shock assembly back into the car, we will need to install the subframe drop spacers. First, locate the under body plastic shields and remove. (3) Bolts and (3) pop clips per panel.

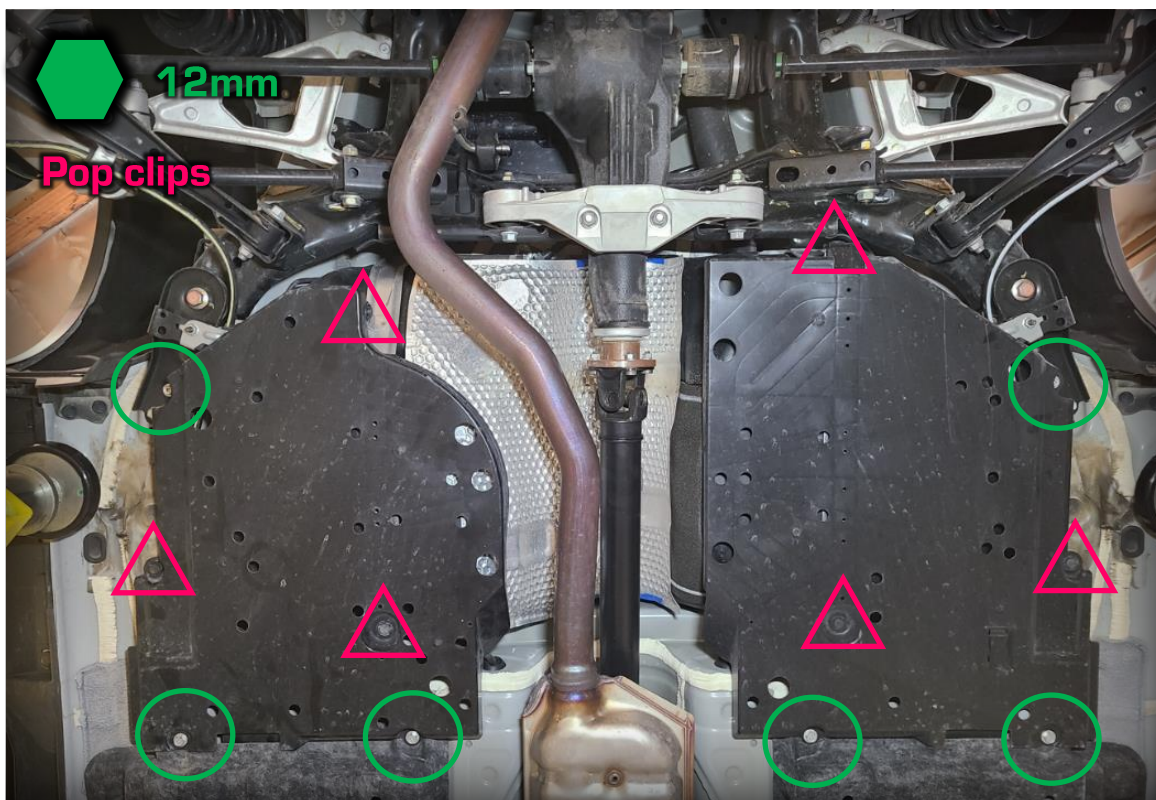

6R Unbolt the brake line tab from the upright and add the aFe extension bracket.



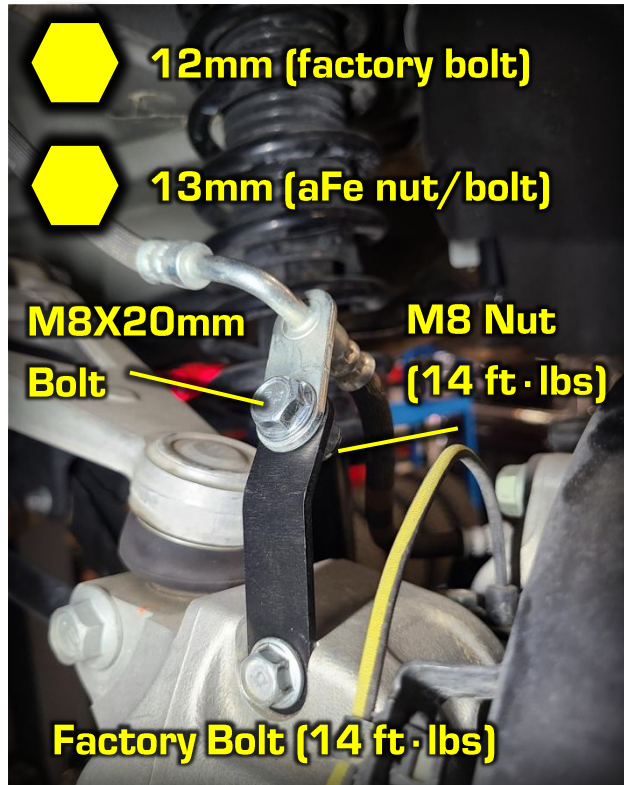

7R Use a jack to support the rear differential.

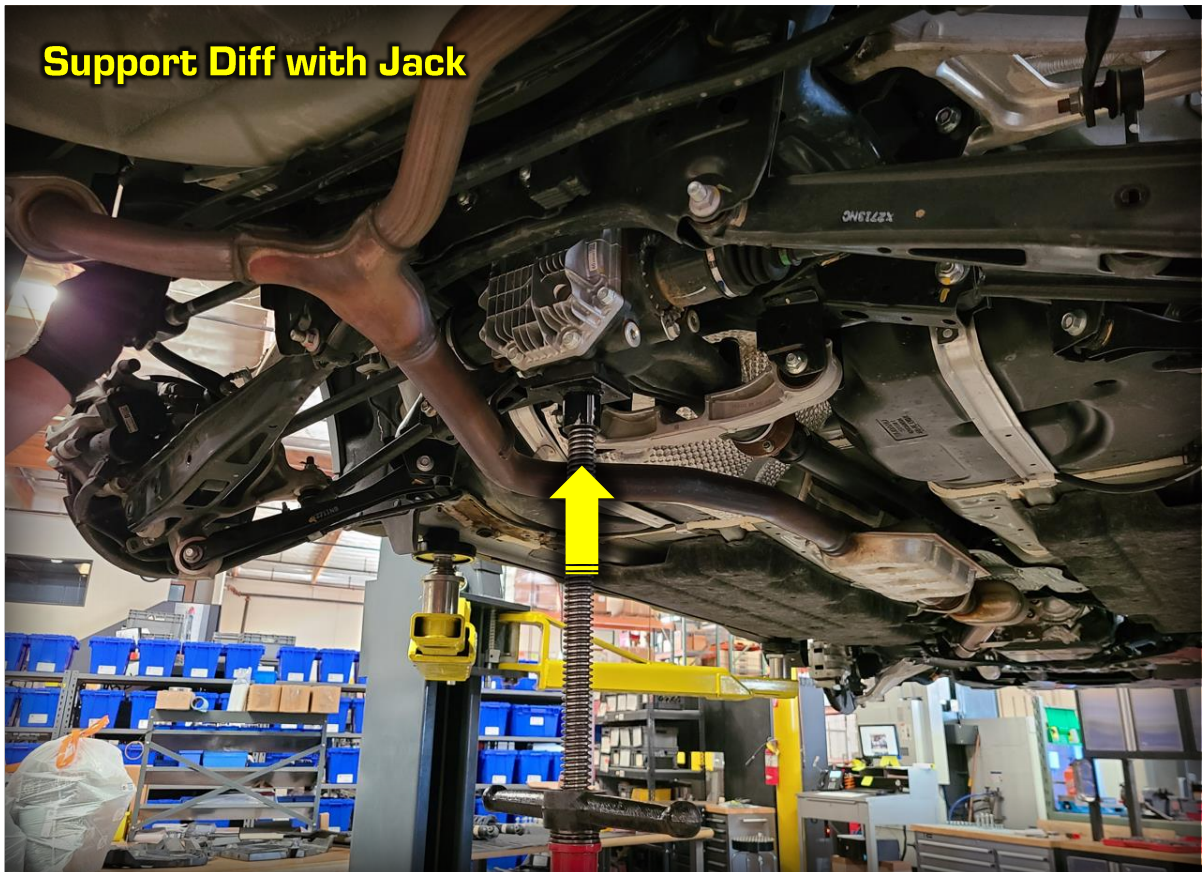

Unbolt all the ancillary subframe bolts shown below. (4) front bolts and 2 rear bolts.

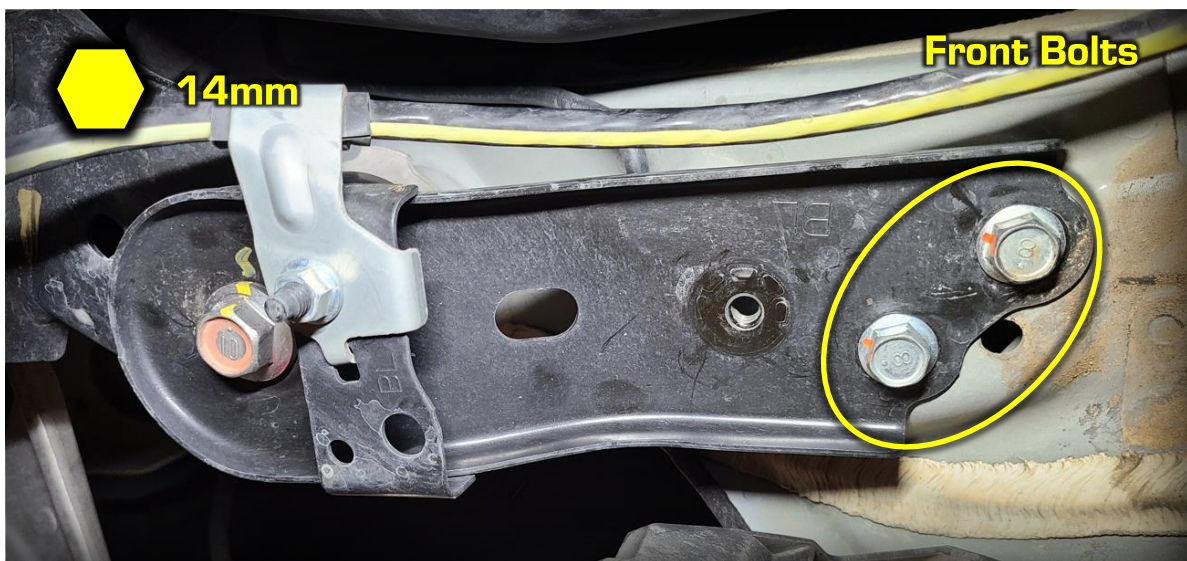
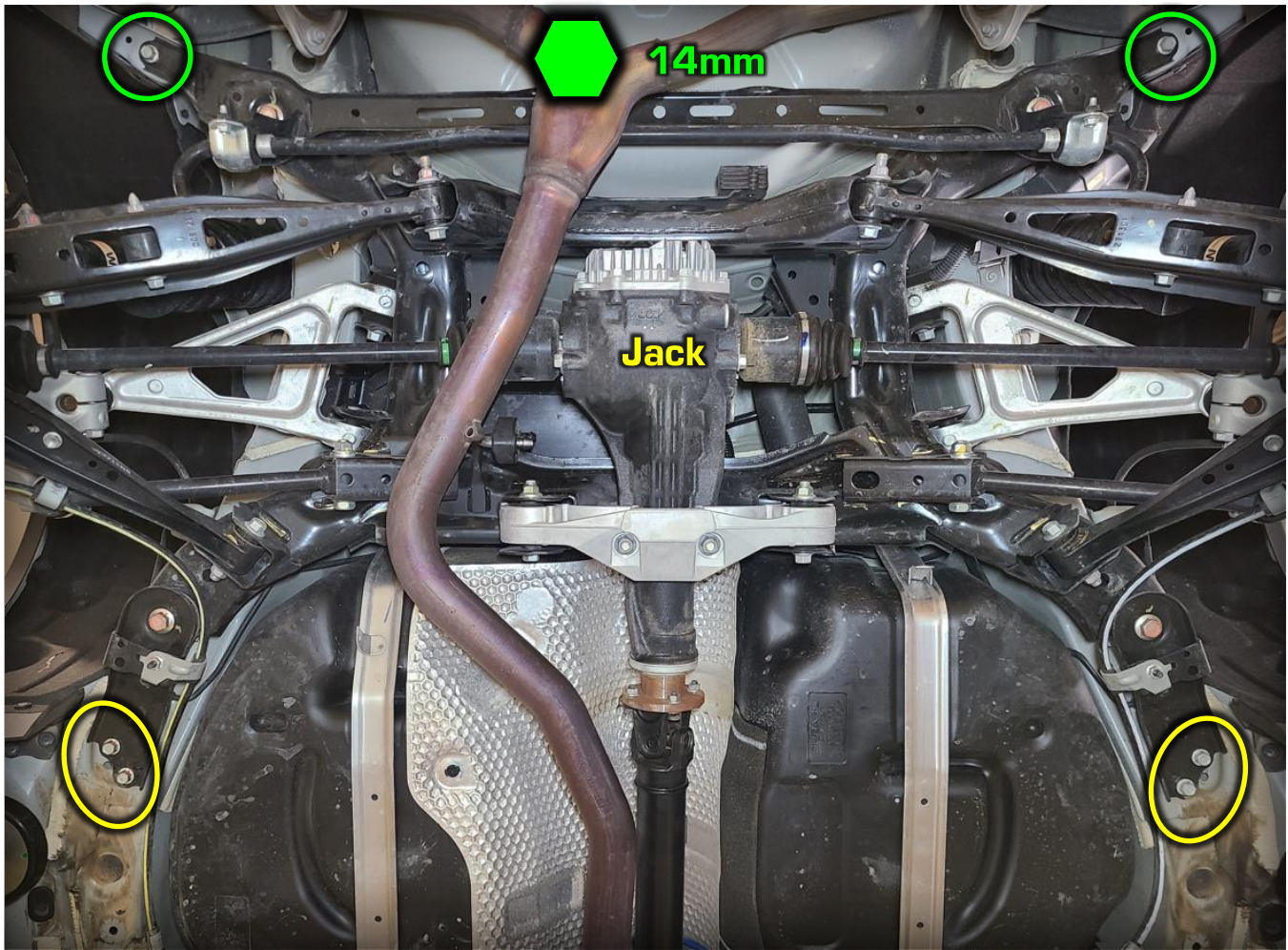

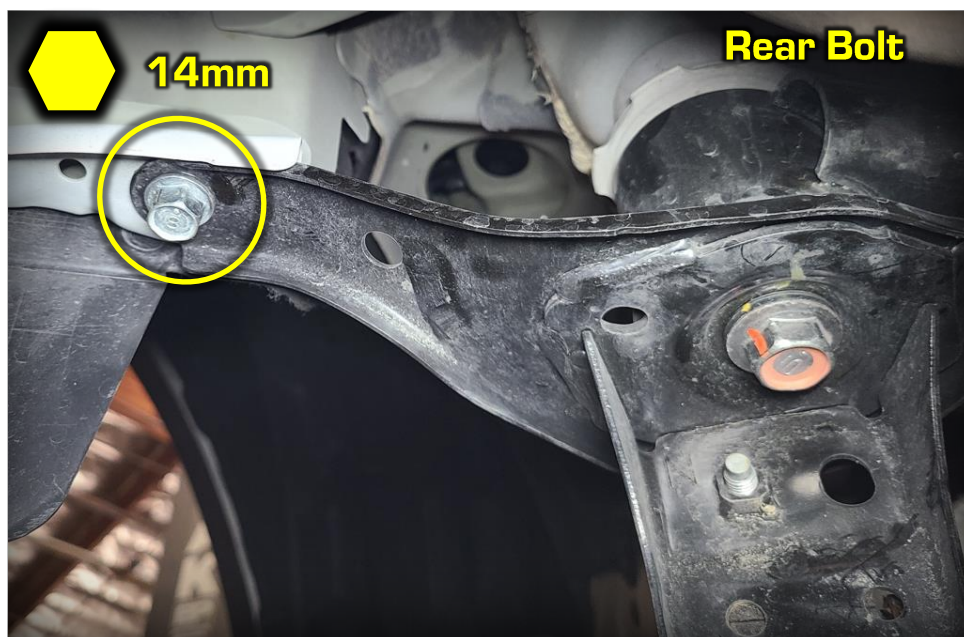

- 8R We will now replace the (4) main subframe bolts one at a time with the aFe bolts. Thread each aFe bolt about 5 threads in. When you get to the last bolt, lower the jack slowly and allow the weight of the subframe to rest on the longer aFe bolts. This should give enough space to begin inserting the subframe spacers.

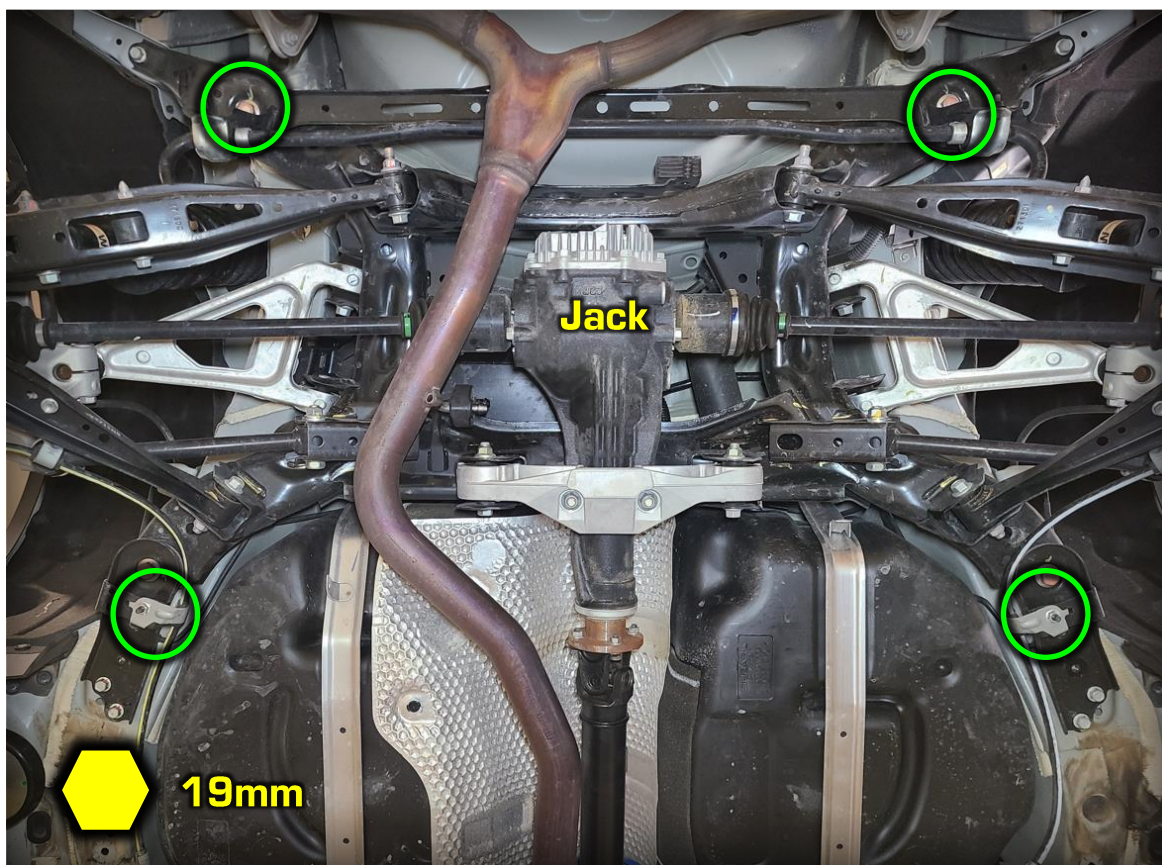

Insert the large round spacer between the unibody and the factory mount. Insert the last aFe bolt and washer. Do not fully tighten at this time.



Now work your way to each subframe bolt. You'll have to unthread the aFe bolt, insert the spacer, and then reinstall the aFe bolt. Make sure you are using the provided washer.

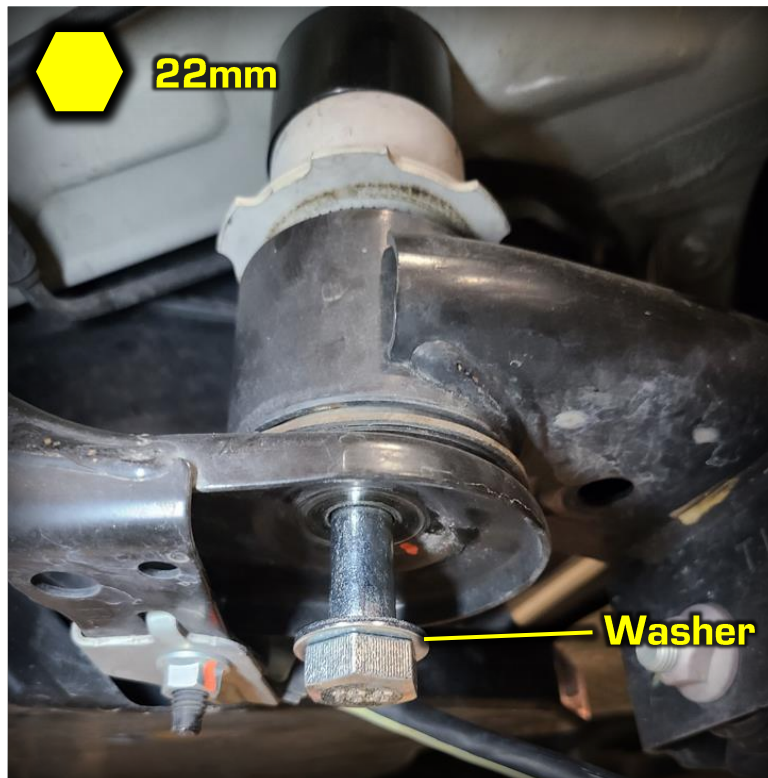

9R Insert front 2- hole spacers and secure with the supplied bolts.



Insert rear spacers and secure with the supplied bolts.



- 10R Once the spacers are installed, fully tighten all the subframe bolts.
1. Main Bolts (M14 - 1.5 x 200mm): **107 ft · lbs**
 2. Front and Rear Mount Bolts (M10 – 1.25 x 60mm): **50 ft · lbs**
- 11R Reinstall the rear shock assembly back into the vehicle. Make sure to use the supplied aFe flange nuts for the top mounts.

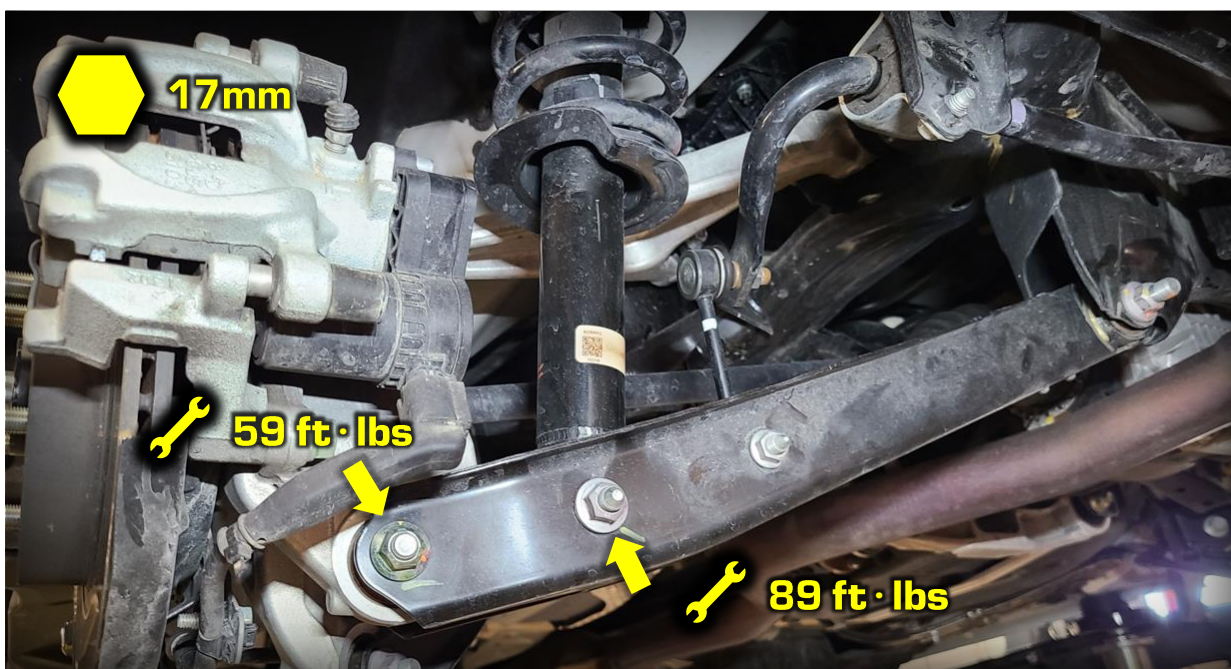
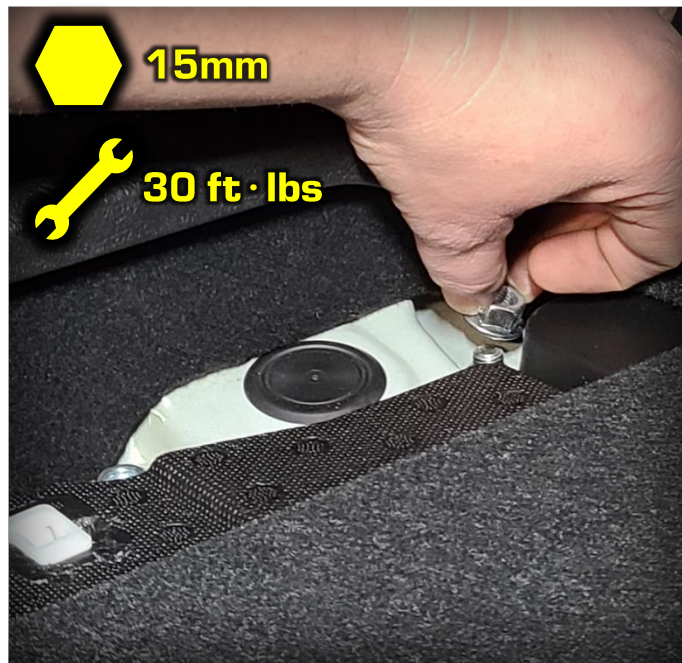

12R Reinstall the plastic under panels in the same manner as removal. However, you will need to omit the side pop clips circled in green. You also need to flip the pop clip direction on the one circled in pink.

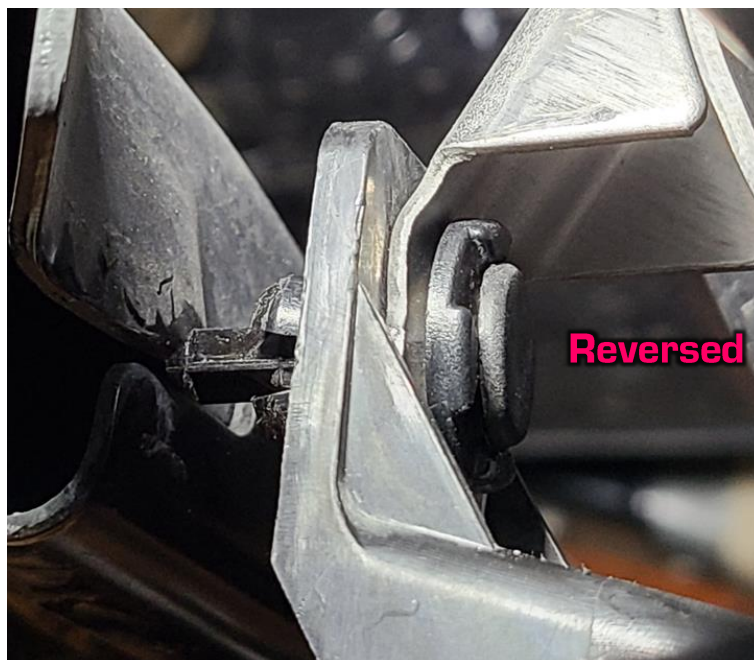
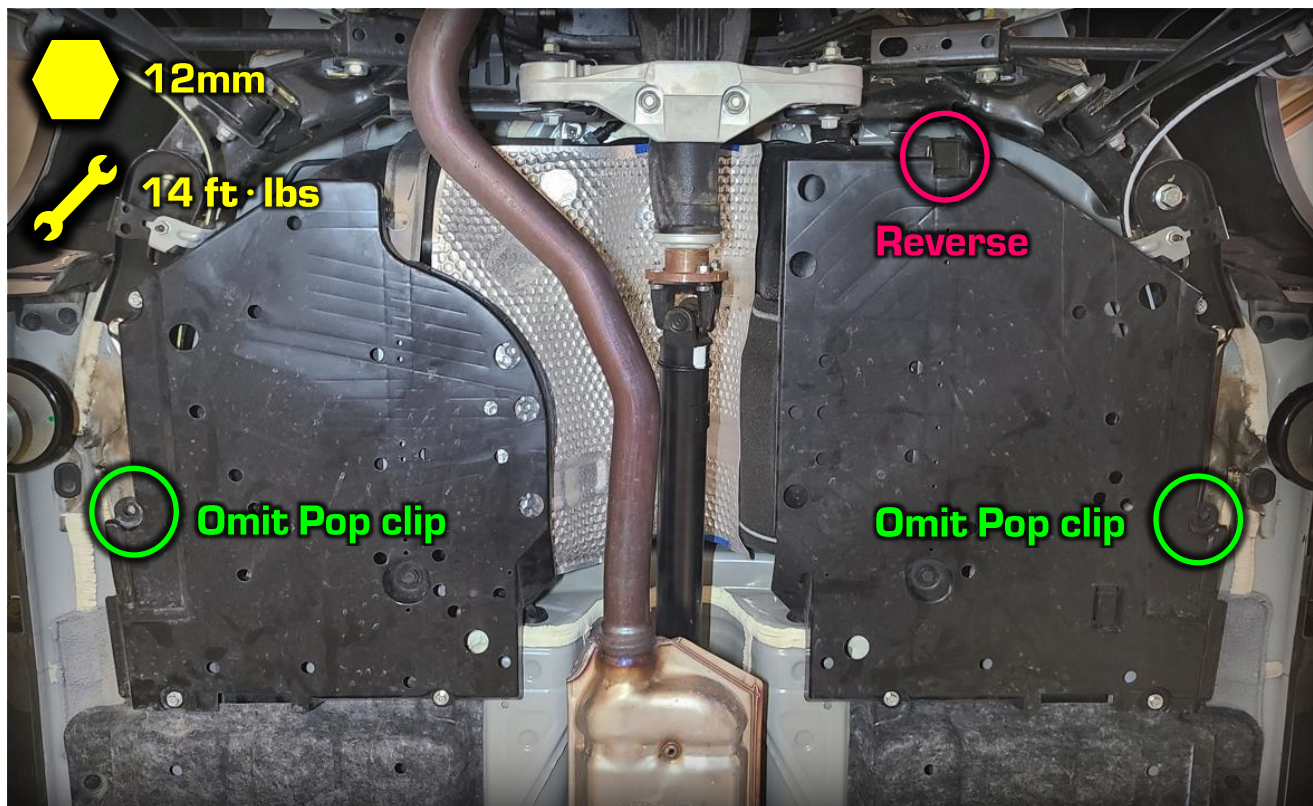

13R Reinstall wheels and perform a 4 wheel alignment.

Final Steps (Performed by installer or alignment shop)

It is a good idea to reset your lower control arm bushings, so they are in a relaxed position at your new ride height. Rotational preload can lead to premature bushing failure.

- Front: Loosen the forward lower control arm bolt
- Rear: Loosen the inboard lower control arm bolt
- Roll vehicle a few feet back and forth to make sure the bushings are reset
- Retighten all the control arm bolts at ride height

Alignment

- Front –
 - Camber: 0° to -0.5°
 - Toe: 0" to 1/16" total toe in
- Rear –
 - Camber: 0° to -1°
 - Toe: 0" to 1/16" total toe in