

GT **MOMENTUM™** **advanced FLOW engineering**

Cold Air Intake System

Instruction Manual P/N: 50-70095DR

Make: Toyota	Model: 4Runner	Year: 2003-2023	Engine: V6-4.0L
Make: Toyota	Model: FJ Cruiser	Year: 2007-2014	Engine: V6-4.0L
Make: Toyota	Model: FJ Cruiser (Non-US Model)	Year: 2015-2023	Engine: V6-4.0L
Make: Toyota	Model: Land Cruiser Prado (Non-US Model)	Year: 2010-2023	Engine: V6-4.0L



- Please read the entire instruction manual before proceeding.
- Ensure all components listed are present.
- For technical support please call 951-493-7185.
- Ensure you have all necessary tools before proceeding.
- Do not attempt to work on your vehicle when the engine is hot.
- Retain factory parts for future use.

Label	Qty.	Description	Part Number
A	1	Air Filter (Pro DRY S)	21-91116
B	1	Tube	05-76009R1 (Used only on late models)
C	1	Tube	05-76010R1 (Used only on earlier models)
D	1	Housing	05-76010R2
E	1	Seal, Trim (17")	05-00007
F	1	Clamp, T-Bolt (8-5/16" – 8-5/8")	03-50267
G	1	Coupling, Silicone Rdr (3x3-1/8)ID x 3"L	05-01400
H	1	Clamp, T-Bolt (3-5/16" – 3-9/16")	03-50292
J	1	Clamp, T-Bolt (3-1/16" – 3-3/8")	03-50320
K	1	Plug, Urethane	05-01225
M	1	Isolation Mount	03-50063
N	1	Washer, Flat: M8 x 24mm OD	03-50065
P	1	Nut, Hex Nylon Lock: M8 x 1.25	03-50244
Q	1	Bolt, M8 1.25 x 25mm	03-50442
R	1	Vacuum Hose 5/32"ID (16")	05-00122
S	1	Brass Hose Nipple	03-50191
T	2	Screw, Torx: M4	03-50491

Installation will require the following tools:

10mm nut driver, phillips screwdriver, 11mm deep socket, 12mm & 13mm sockets and drivers, T20 driver, and E6 size star socket

Note: Pictures used in instructions are of the black kit, but installation will be the same for both kits

Warranty Information available at <https://afepower.com/contact#warranty>

Emissions Disclaimer: This product is not currently CARB exempt and is not available for purchase in California or for use on any vehicle registered with the California Department of Motor Vehicles.

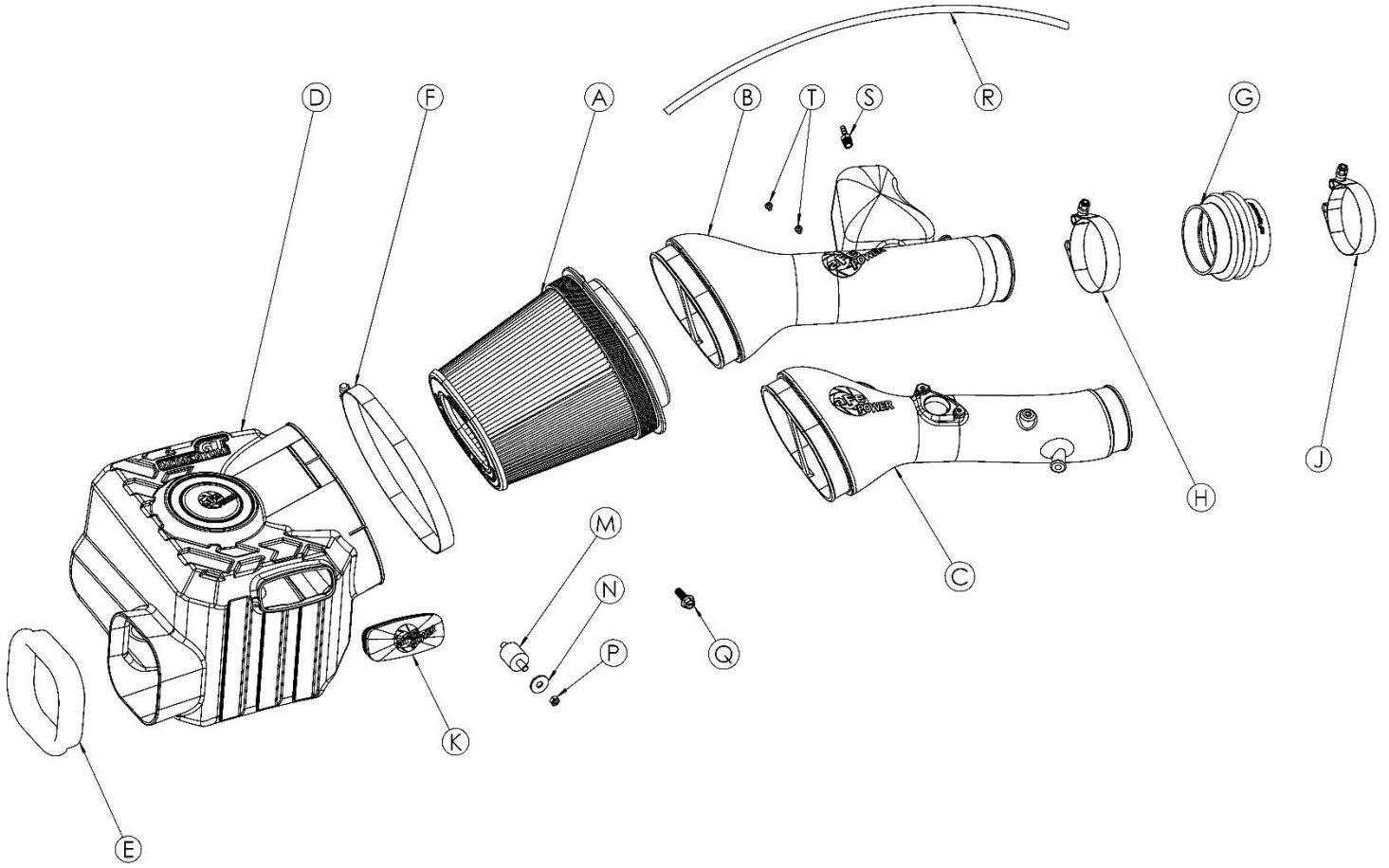
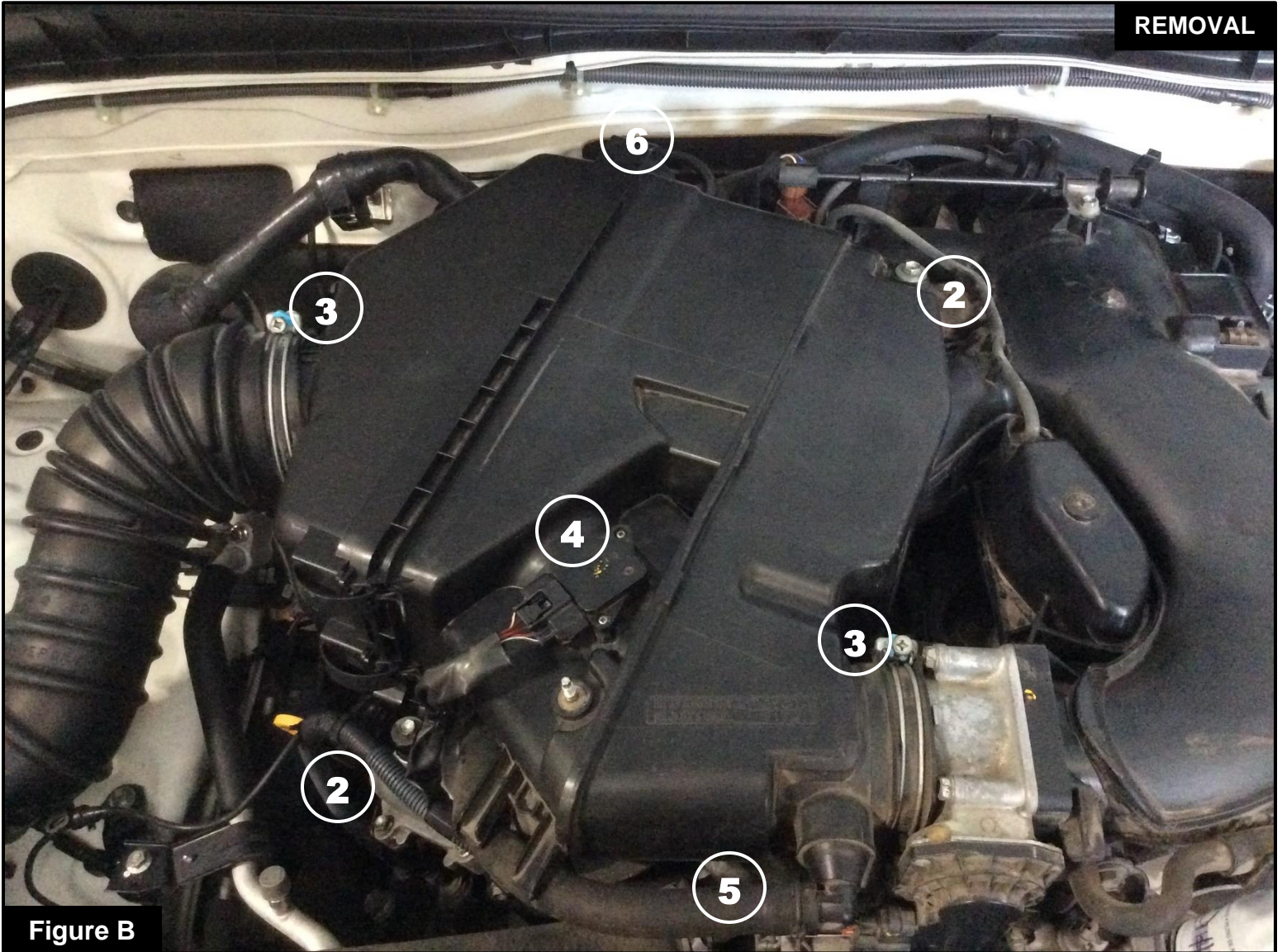

**Figure A****Refer to Figure A for Step 1**

For later model years that include the 05-760091B1 tube, please skip to page 18.

All earlier model years that include the 05-76010B1 tube, refer to Figure A for Step 1.

Step 1: Using a 10mm nut driver, remove the two nuts (1) holding the engine cover and set the cover aside.

**Figure B****Refer to Figure B for Steps 2-6**

Step 2: Using a 10mm nut driver, remove the two screws (2) securing the OE airbox and loosen the clamps (3) at the throttle body and intake snorkel.

Step 3: Disconnect the MAF sensor (4) and wire clips.

Step 4: Disconnect the Crank Case Vent line (5).

Step 5: Disconnect the small vacuum line on the rear of the OE intake (6).

Step 6: Remove the entire stock intake housing by gently pulling it away from the throttle body, then disconnecting it from the intake snorkel.

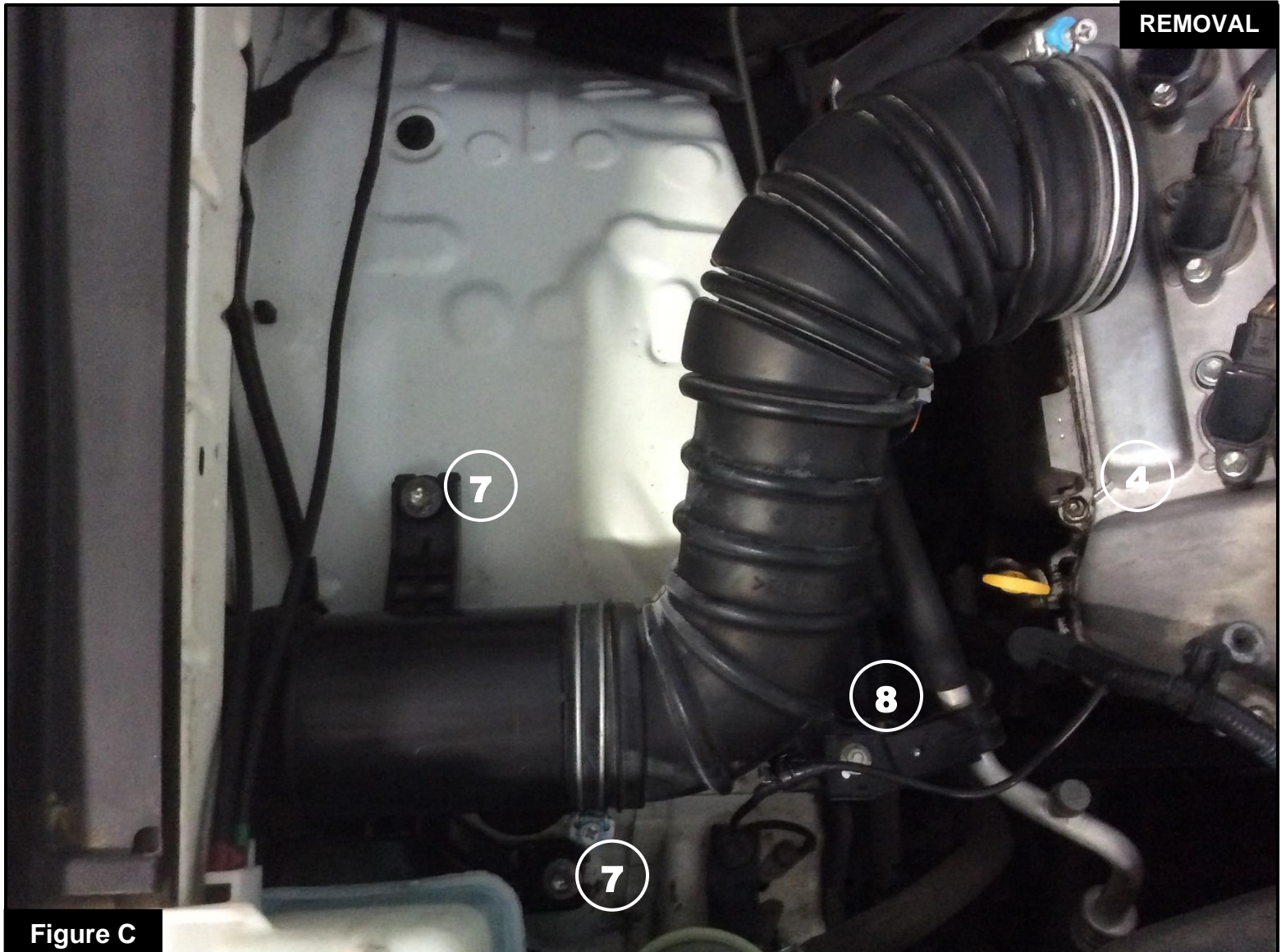
**Figure C****Refer to Figure C for Step 7**

Step 7: Using a 12mm socket and extension, remove the two screws (7) holding the OE air intake snorkel, then disconnect the wire clip (8) and remove the stock intake snorkel.

**Figure D****Refer to Figure D for Step 8**

Step 8: Replace the stock 5/32" vacuum line (9) with the supplied 5/32" hose.



Refer to Figure E for Step 9

Step 9: Remove and transfer two steel sleeves and two rubber isolation grommets (10) from the stock intake housing to the aFe housing in the rear-most mounting points (11) .

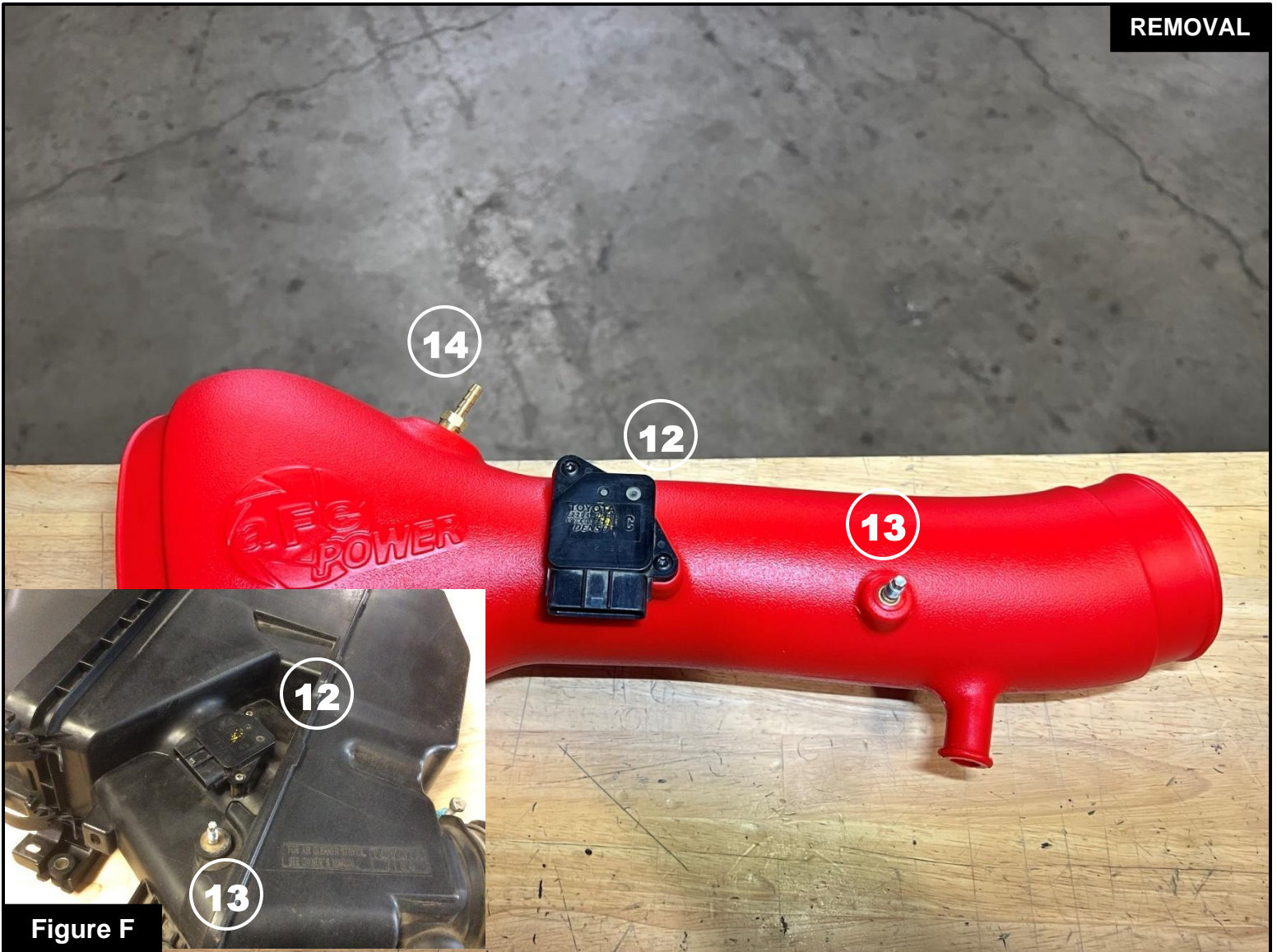
**Figure F****Refer to Figure F for Step 10-12**

Step 10: Remove the MAF sensor (12) from the OE airbox using a #1 Philips head screwdriver and reinstall the sensor into the aFe intake tube using the supplied T20 Torx screws.

Step 11: Using an E6 star socket, remove the mounting stud (13) from the OE intake and install into the threaded insert on the aFe intake tube.

Step 12: Install the brass hose fitting (14) into the aFe intake tube, and tighten using an 11mm wrench.

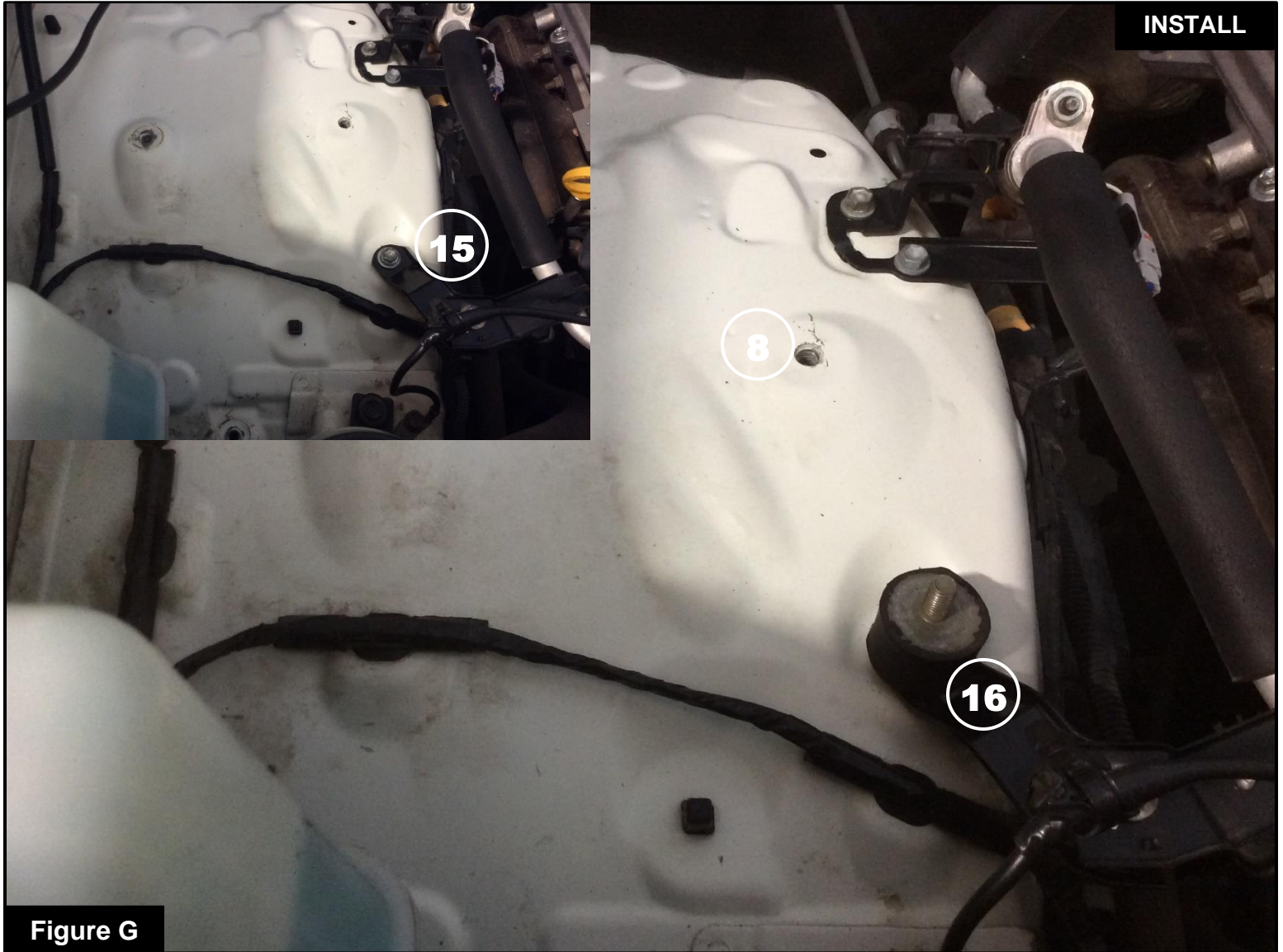

Figure G

Refer to Figure G for Step 13

Step 13: Using a 10mm socket, remove the screw (15) holding the A/C bracket and replace it with the supplied M8 isolation mount (16). Hand tighten the rubber isolation mount only.



Refer to Figure H for Step 14

Step 14: Install the supplied trim seal on the aFe air box. Trim to fit.



Figure I

Refer to Figure I for Step 15

Step 15: Place the aFe air box into the vehicle and secure using one of the 12mm screws removed in Step 7 in the left-most mounting location (17). Use the supplied M8 screw in the right-rear mounting location (18) and tighten using a 12mm socket. Using the supplied M8 nut and washer, tighten down the air box onto the isolation mount (19) using a 13mm socket.



Figure J

Refer to Figure J for Steps 16

Step 16: Install the supplied large T-bolt clamp (20) onto the airbox and slide the air filter into the air box. Do not tighten the clamp at this time.

**Figure K****Refer to Figure K for Steps 17-18**

- Step 17: Install the supplied reducer coupling with the smaller T-bolt clamp (21) onto the throttle body (Lettering on the couple should be away from the throttle body). Tighten the clamp at the throttle body.
- Step 18: Place the larger T-bolt clamp (22) onto the couple, but do NOT tighten at this time.

**Figure L****Refer to Figure L for Step 19**

Step 19: Install the intake tube into the vehicle by sliding the tube first into the coupler on the throttle body, then into the air filter. Tighten all clamps.

**Figure M****Refer to Figure M for Step 20**

Step 20: Reconnect the crank case vent hose (23) and 5/32" vacuum line (24) to the aFe intake tube. Reconnect the MAF sensor (25).

**Figure N****Refer to Figure N for Steps 21-22**

Step 21: Reinstall the engine cover utilizing the M6 stud on the aFe intake tube and secure it using the stock 10mm nuts.

Step 22: (Optional) Use the provided plug to close off the additional air inlet if you want to completely seal the air box. Best performance gains are obtained without the plug.

Note: Your installation is now complete. Check that all bolts, clamps, and connectors are still secure after 200 miles.

**Figure O****Refer to Figure O for Steps 23**

For later model years that include the 05-76009B1 tube, please start here on page 18.

Step 23: Remove the engine cover ① by gently pulling up on the front and disengaging from the hinges at the rear. Set the cover aside.



Refer to Figure P for Steps 24-25

Step 24: Using a 10mm nut driver, loosen the stock clamps 2 at the throttle body and OE air box.

Step 25: Disconnect the two vent hoses 3 from the stock intake tube.

**Figure Q****Refer to Figure Q for Steps 26-27**

Step 26: Disconnect the Mass Airflow Sensor (4) and disengage the wire clips (5) from the stock airbox and rear of the resonance chamber.

Step 27: Using a 10mm socket, remove the screw (6) from the support brace at the resonance chamber. Remove the stock intake tube and set aside.

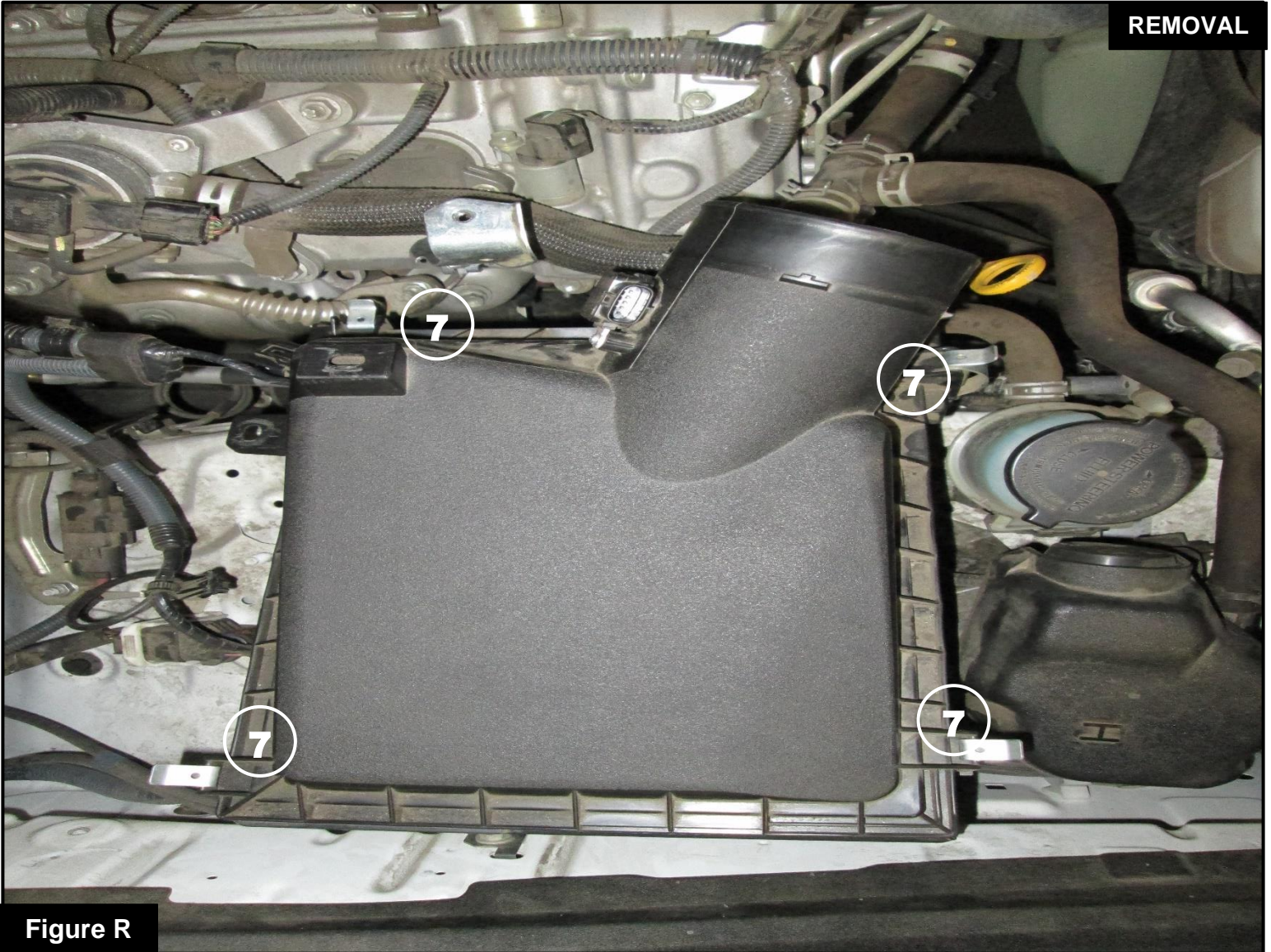
**Figure R****Refer to Figure R for Step 28**

Step 28: Disengage the four clips (7) on the OE air box and remove the top and filter. Set aside.

**Figure S****Refer to Figure S for Step 29**

Step 29: Using a 12mm socket and extension, remove the three screws (8) holding the stock air box and remove. Retain screws for later use.

**Figure T****Refer to Figure T for Step 30**

Step 30: Using a 10mm socket and extension, remove the retaining screw and support bracket ⑨ from the vehicle.



Figure U

Refer to Figure U for Step 31

Step 31: Install the supplied M8 rubber isolation mount (10) into the front-most threaded hole. Hand tighten only.



Figure V

Refer to Figure V for Step 32

Step 32: Install the supplied trim seal on the aFe air box. Trim to fit.

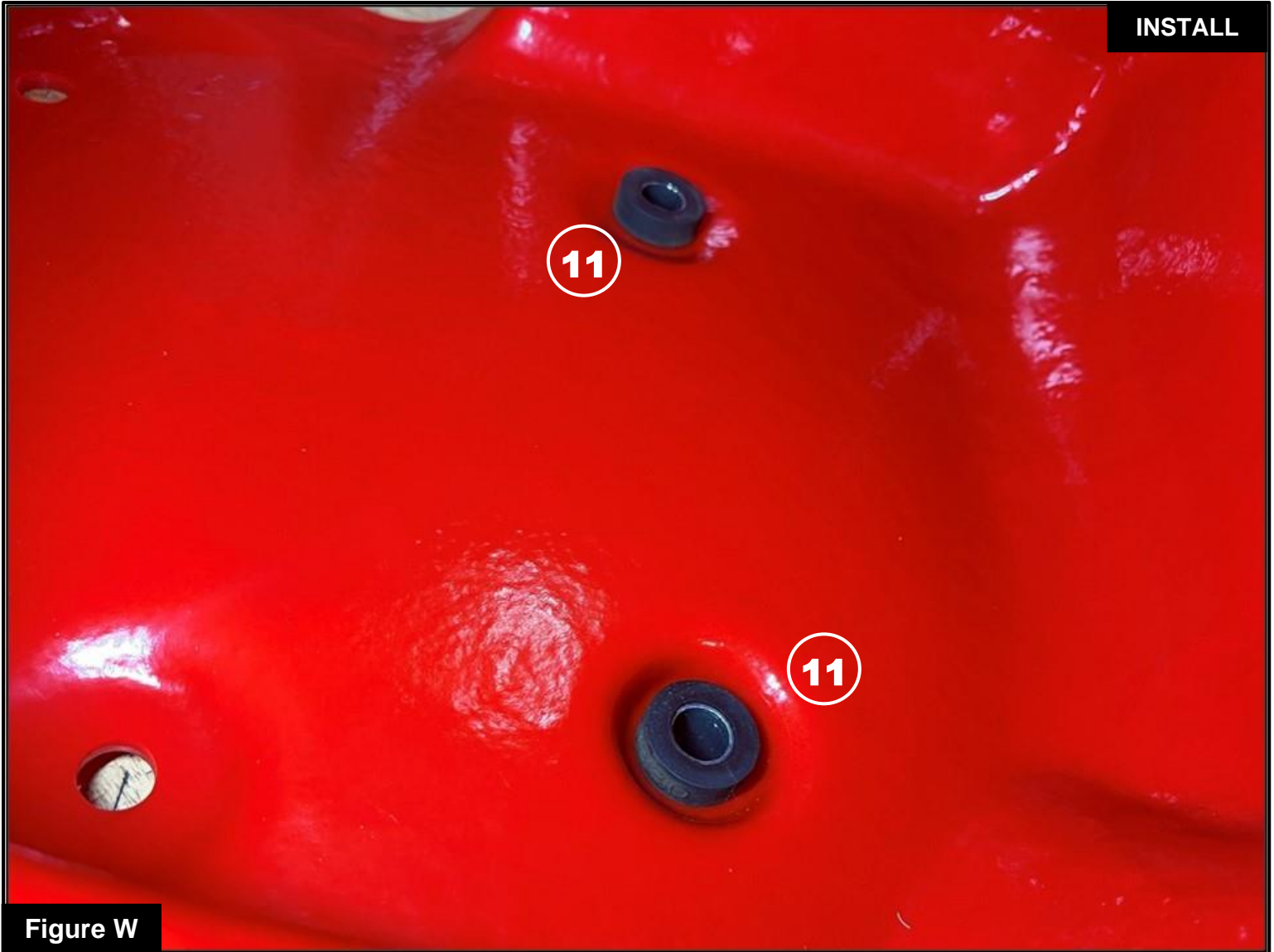
**Figure W****Refer to Figure W for Step 33**

Step 33: Remove and transfer two steel sleeves and two rubber grommets (11) from the stock airbox to the Momentum housing in the rear most mounting points.

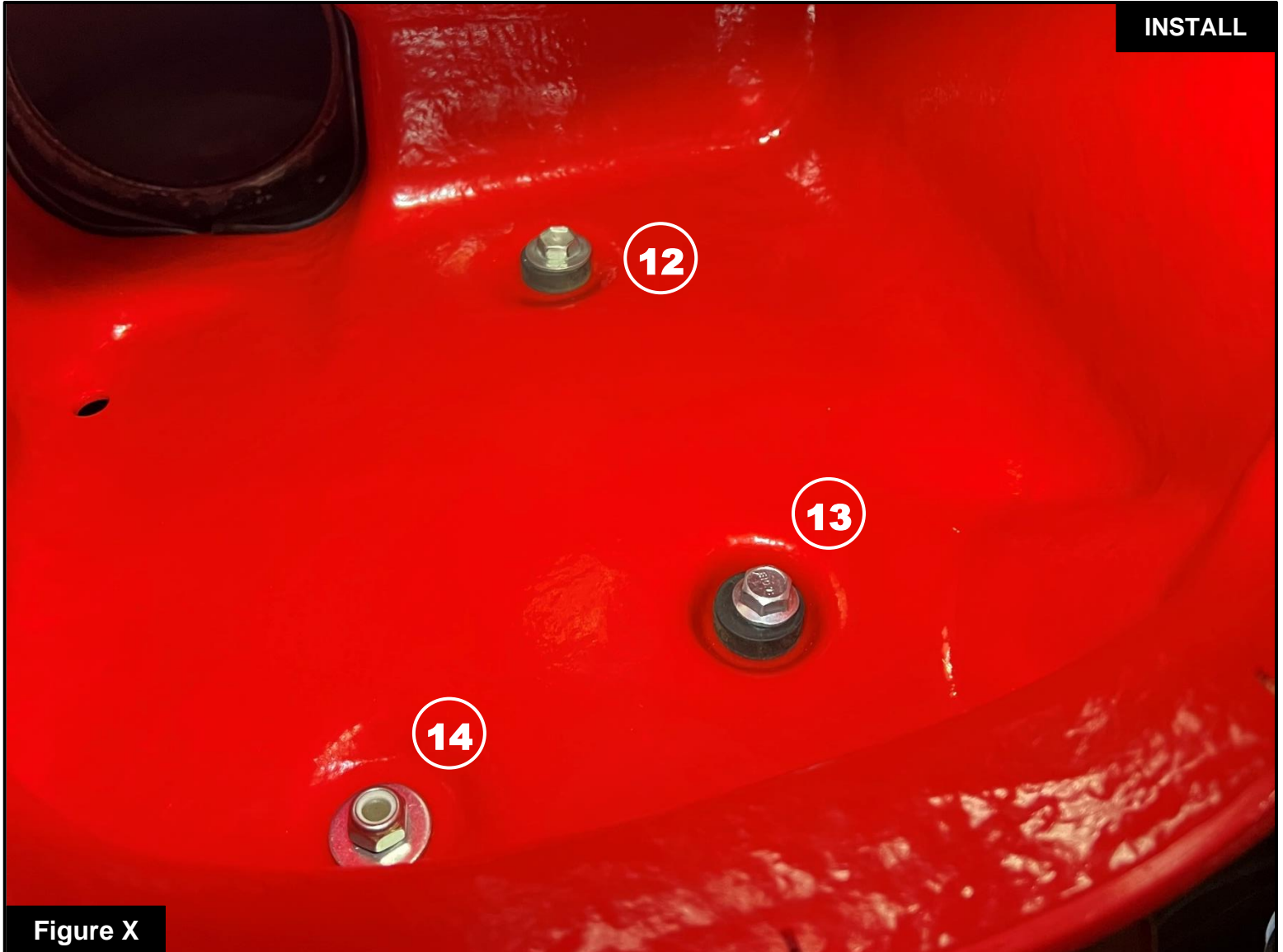
**Figure X****Refer to Figure X for Step 34**

Step 34: Place the aFe air box into the vehicle and secure using one of the 12mm screws removed in Step 7 in the left-most mounting location (12). Use the supplied M8 screw in the right-rear mounting location (13) and tighten using a 12mm socket. Using the supplied M8 nut and washer, tighten down the air box onto the isolation mount (14) using a 13mm socket and driver.



Figure Y

Refer to Figure Y for Step 35

Step 35: Install the supplied large T-bolt clamp (15) onto the air box and slide the air filter into the air box. Do not tighten the clamps at this time.

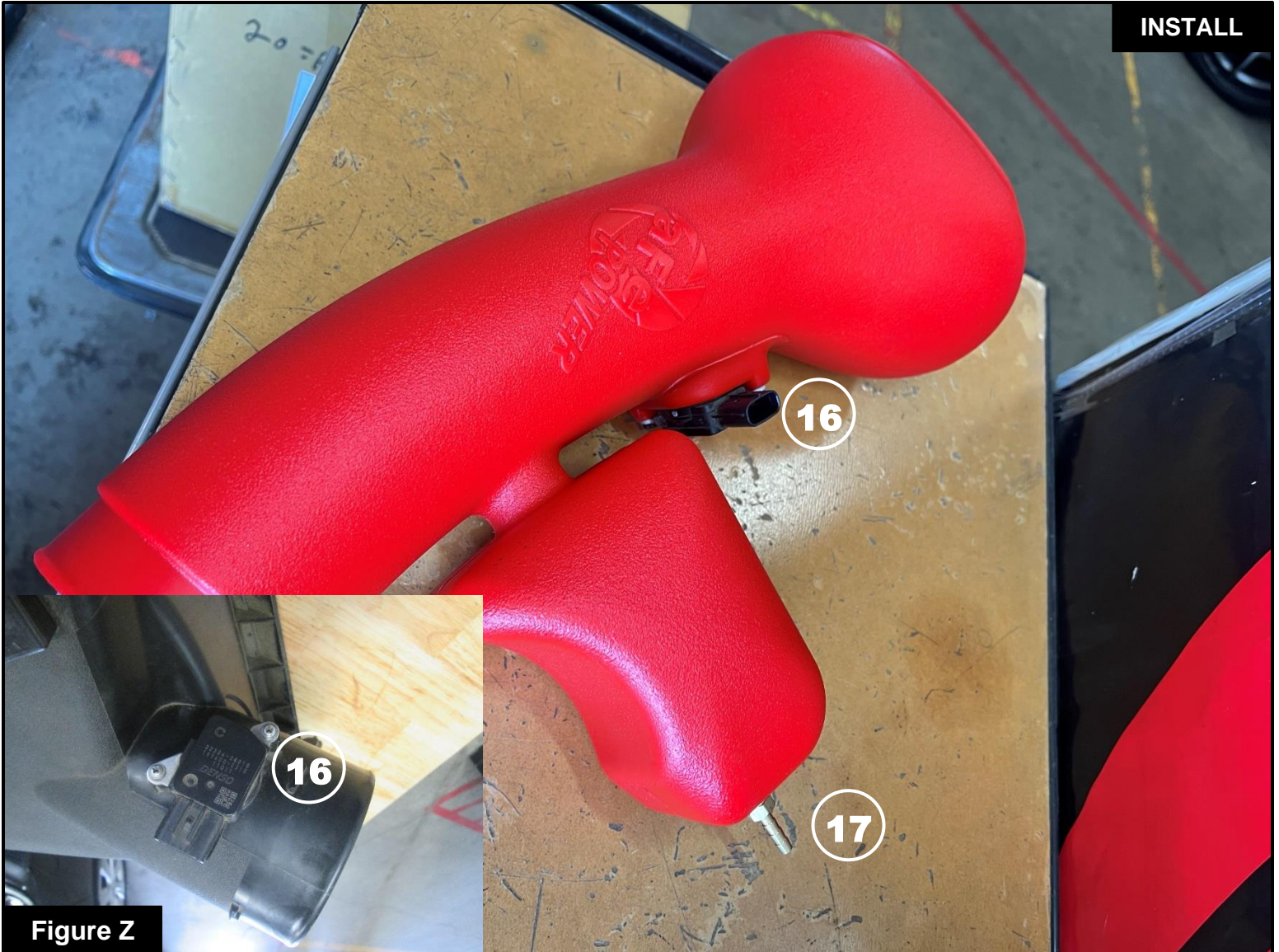
**Figure Z****Refer to Figure Z for Steps 36-37**

Step 36: Remove the MAF sensor (16) from the OE air box using a #1 Philips head screwdriver and reinstall into the aFe intake tube using the supplied T20 Torx screws.

Step 37: Install the brass hose fitting (17) in the aFe intake tube and tighten using an 11mm wrench or socket.

Figure AA

Refer to Figure AA for Step 38

Step 38: Install the supplied reducing coupler with the smaller T-bolt clamp ⑱ onto the throttle body (lettering on the coupler should be away from the throttle body) and tighten the clamp. Place the larger T-bolt clamp ⑲ on the coupler, but do not tighten at this time.

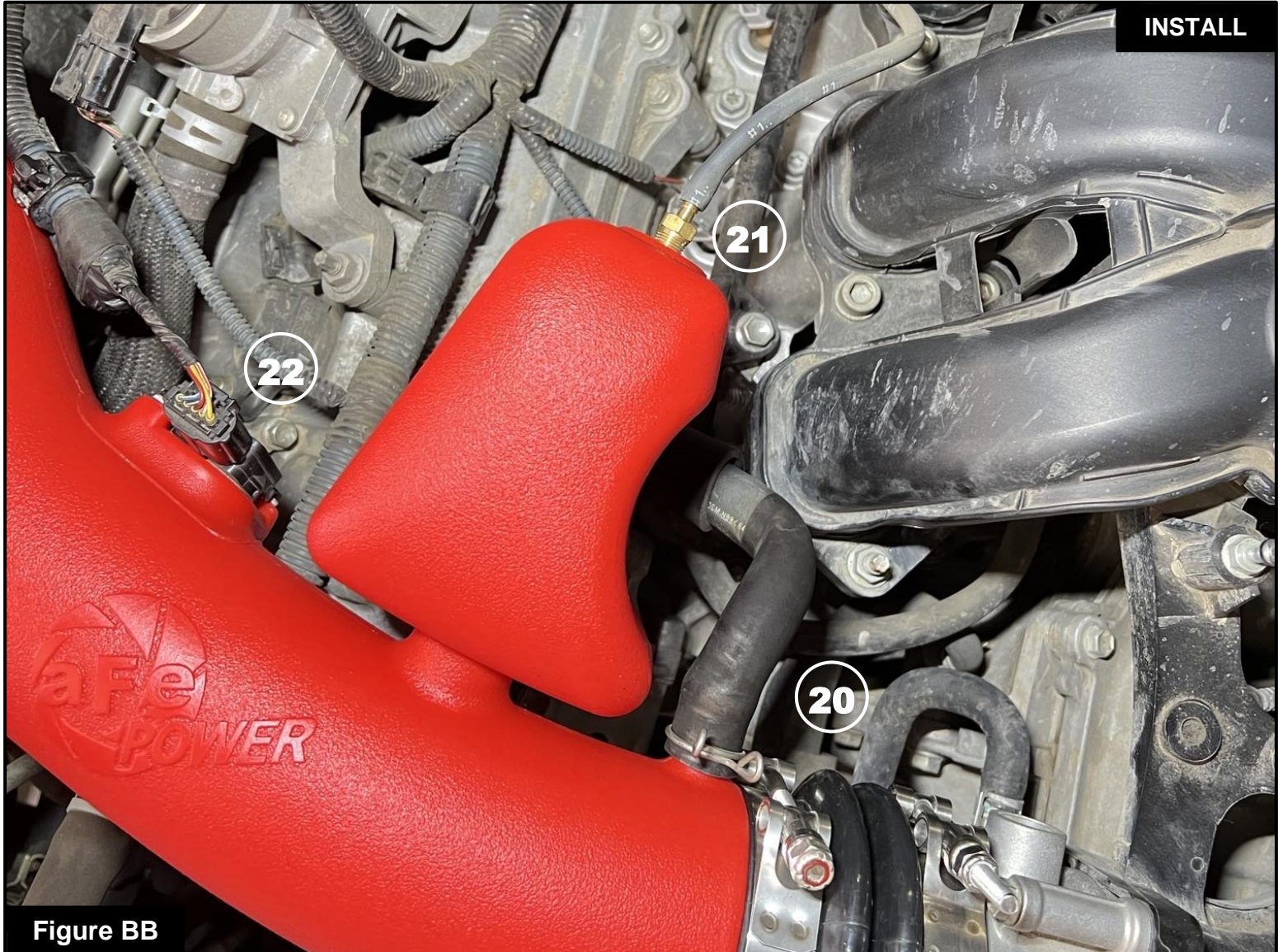

Figure BB

Refer to Figure BB for Steps 39-40

Step 39: Install the intake tube into the vehicle by sliding the tube into the coupling on the throttle body first, then into the filter. Tighten all clamps using an 11mm deep socket and driver (As shown in picture).

Step 40: Connect the crank case vent hose (20) to the aFe intake tube, and connect the 5/32" vacuum hose (21) to the aFe intake tube. Reconnect the MAF sensor (22).



Figure CC

Refer to Figure CC for Step 41

Step 41: Reinstall the engine cover



Figure DD

Refer to Figure DD for Step 42

Step 42: Use the provided plug 23 to close off the additional air inlet if you want to completely seal the air box. Best performance gains are obtained without the plug in place. Check that all components are tight and secure. Your installation is now complete. Thank you for choosing aFe Power!

Note: Your installation is now complete. Check that all bolts, clamps, and connectors are still secure after 200 miles.



Page left blank intentionally



Page left blank intentionally



advanced FLOW engineering, inc.

Corona, CA 92879

<https://afepower.com/contact>