



advanced FLOW engineering

**Instruction Manual** P/N: 46-80006

BladeRunner – Transmission Oil Cooler Kit

Make: RAM

Model: 1500 TRX

Year: 2021-2023

Engine: V8-6.2L (sc)



- Please read the entire instruction manual before proceeding.
- Ensure all components listed are present.
- For technical support please call 951-493-7185.
- Ensure you have all necessary tools before proceeding.
- Do not attempt to work on your vehicle when the engine is hot.
- Retain factory parts for future use.

Label	Qty.	UoM	Description	Part Number
A	1	ea.	Oil Cooler: 46-80003	05-60933
B	1	ea.	Fitting, Adaptor: Dodge Trans Line: 46-80005	05-01603
C	1	ea.	Fitting, 3/4-16 O-Ring to AN -8	05-61180
D	3	ea.	Fitting, 1/2" Push-On to AN -8 (90 Deg) Blk	05-60683B
E	1	ea.	Bracket, Lower Mount PS: 46-80006	05-61263
F	1	ea.	Bracket, Lower Mount DS: 46-80006	05-61264
G	1	ea.	Bracket, Upper Mount: 46-80006	05-61265
H	50.5	in.	Hose, Fuel: Gates 1/2" 50psi	05-60558
J	10	in.	Hose, Fuel: Gates 1/2" 50psi	05-60558
K	4	ea.	Ties, Nylon Cable: 12", 50 lb. Black	05-60167
M	8	ea.	M6 Hex Nut	03-50059
N	8	ea.	M6 x 20mm Screw, Button Head	03-50241

**Installation will require the following tools:**

10mm socket, trim removal tool, 10mm wrench, small picks, Ratchet, 3" extension, 6" extension, 7/8 wrench, 1" Wrench, 1 3/16 wrench, 15mm socket, wire cutters, 4mm allen

Warranty Information available at <https://afepower.com/contact#warranty>

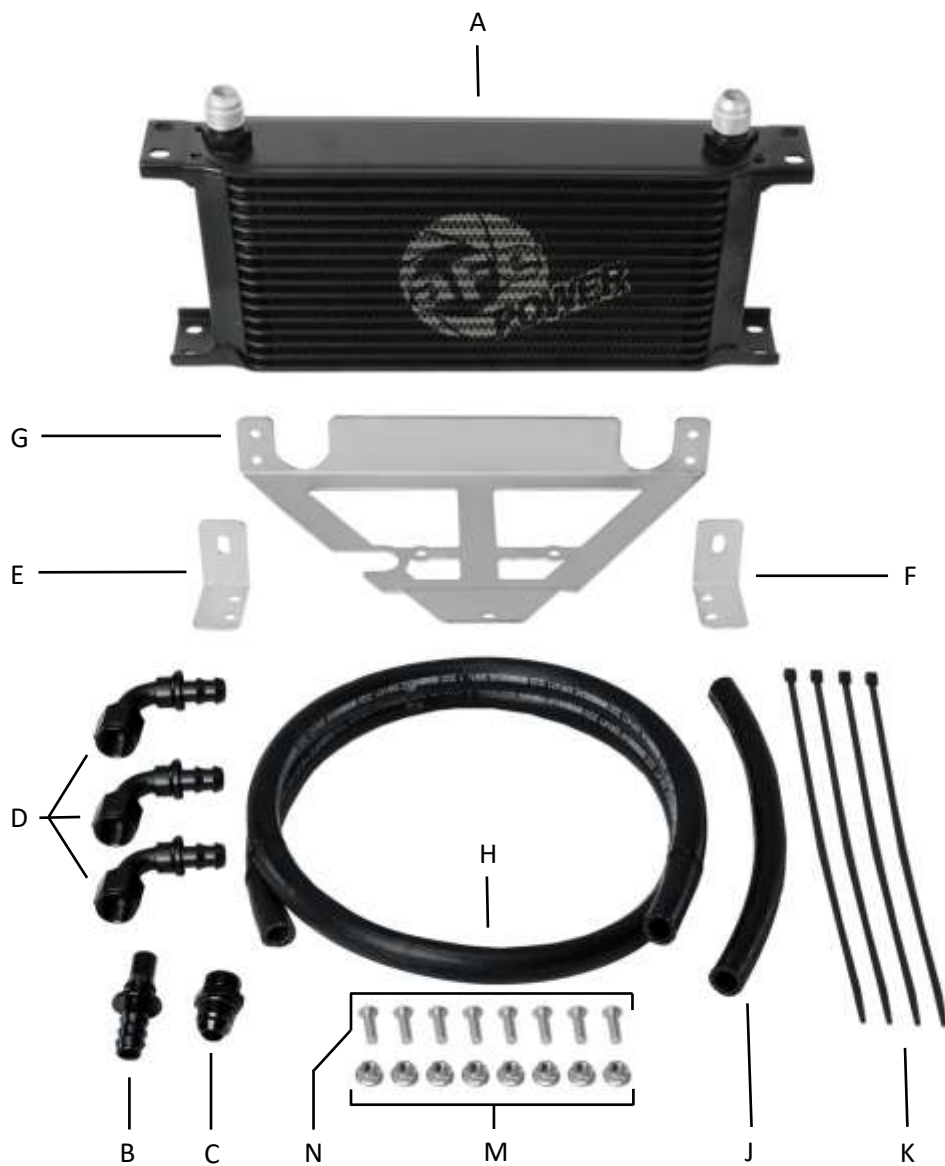
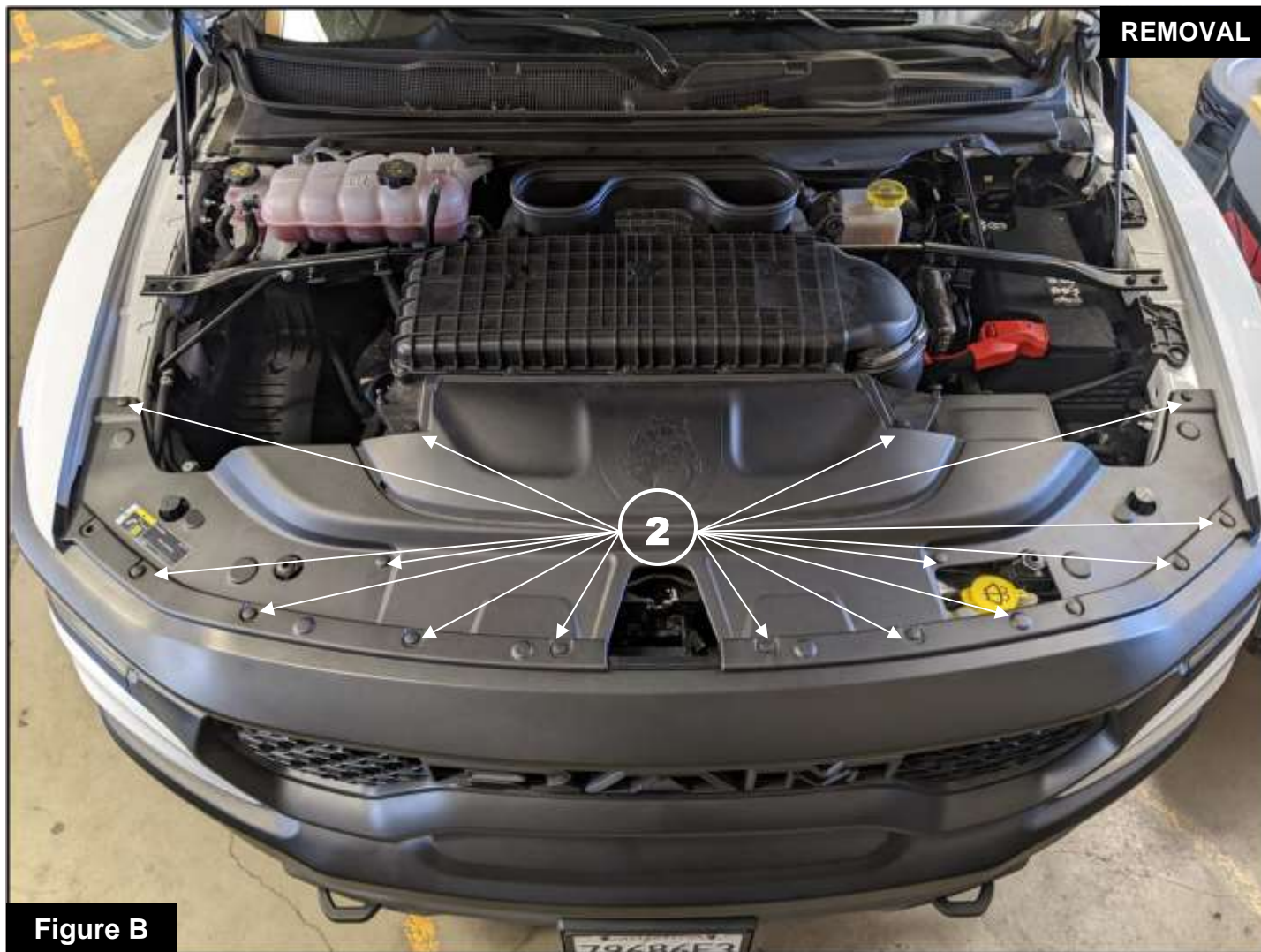



Figure A

**Refer to Figure A for Step 1**

Step 1: Remove your engine cover. ①



**Figure B**

**Refer to Figure B for Step 2**

Step 2: Using a small trim removal tool, remove the sixteen (16) push clips (2) from the close out panel. Remove the close out panel and retain all parts and hardware for reassembly.

**Figure C****Refer to Figure C for Steps 3-4**

Step 3: Using a 10mm socket and ratchet, remove the eight (8) 10mm bolts (3) and the two (2) push clips (4) from the header assembly. Retain the hardware for reassembly.

Step 4: Remove the header assembly by pulling straight out from the truck.



**Refer to Figure D for Step 5**

**Note: You will have to pull hard to get these clips to release. Please use caution while pulling.**

Step 5: Using your hand, pull on the fascia trim under the headlights to release the clips and give access to the grille hardware.

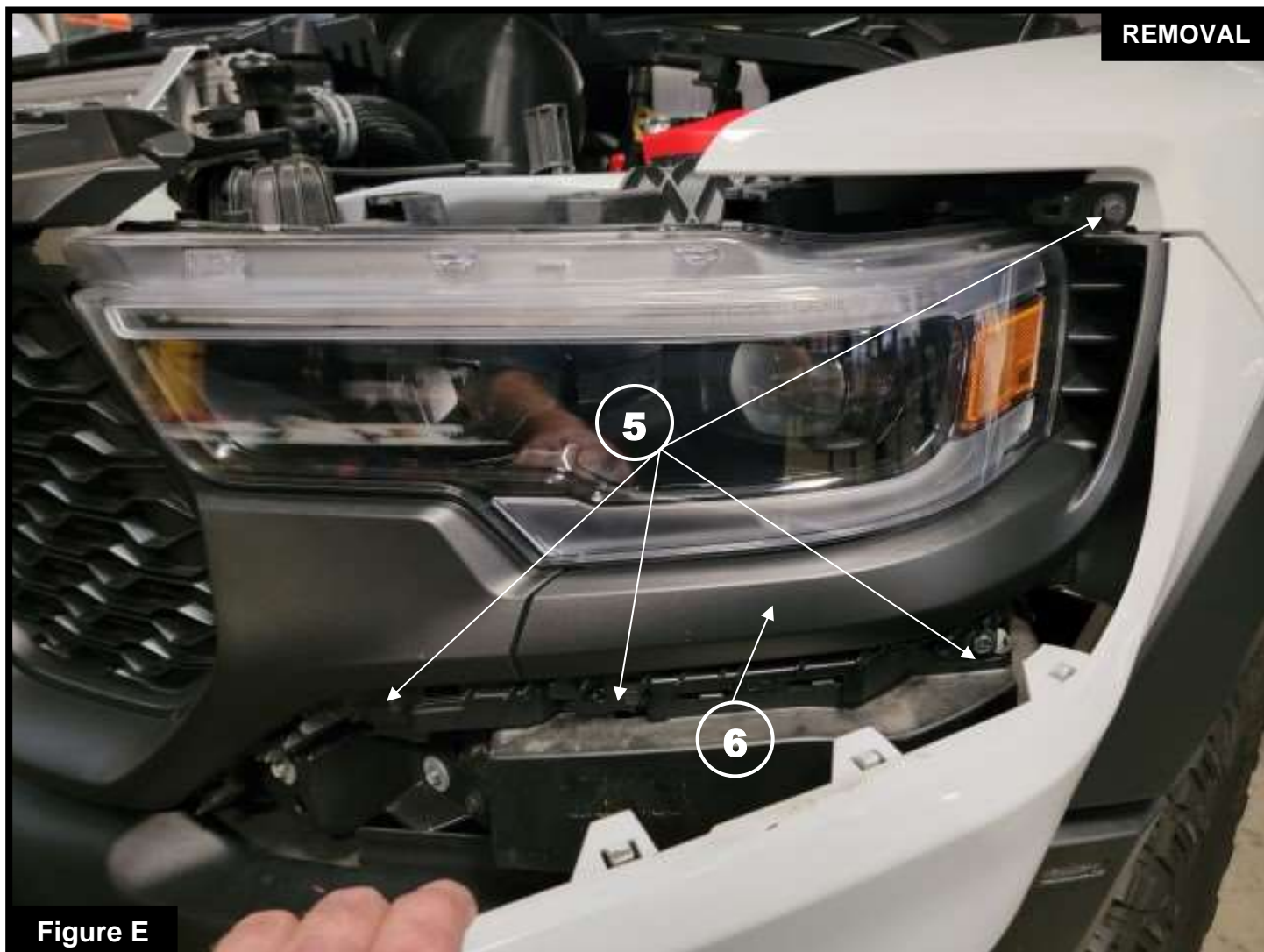

**Refer to Figure E for Step 6**

Step 6: Using a 10mm socket and ratchet, remove the eight (8) bolts (5) from the grille assembly around both the right and left headlight trim pieces. Remove the headlight trim pieces. (6)  
Retain the hardware for reassembly.



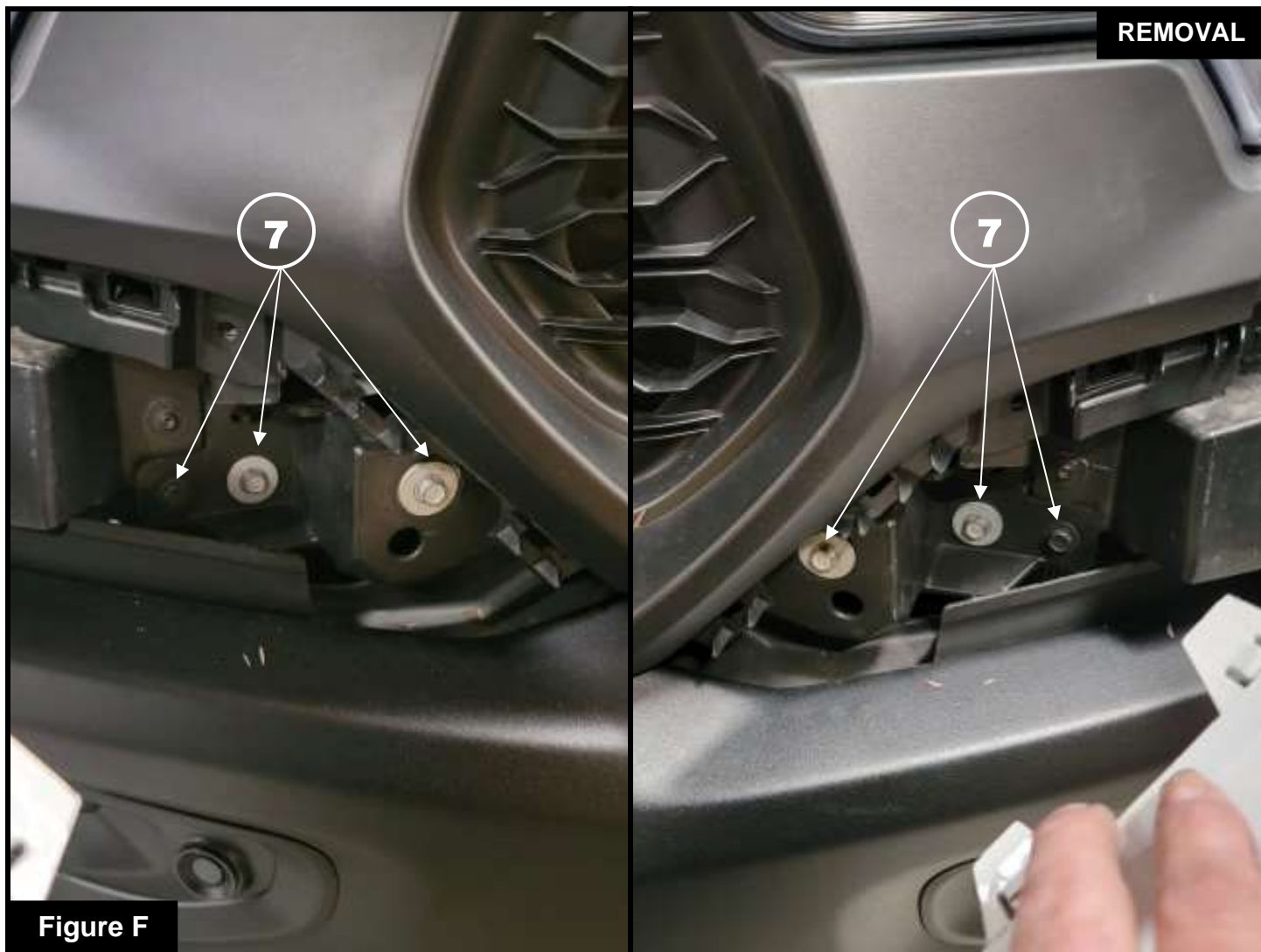
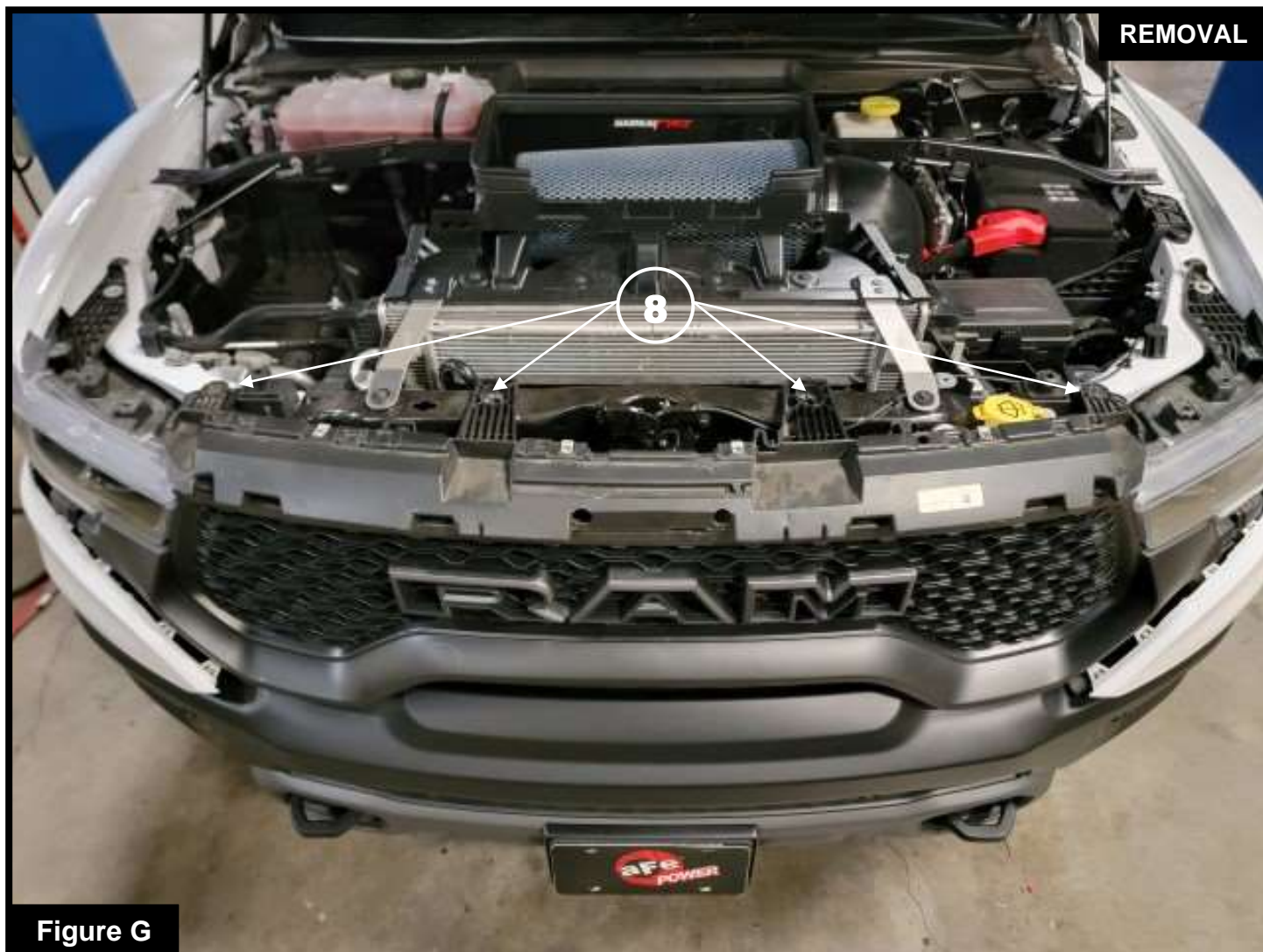

Figure F

**Refer to Figure F for Step 7**

Step 7: Using a 10mm socket and ratchet, remove the six (6) bolts (7) under the grille assembly. Retain the hardware for reassembly.



**Figure G**

**Refer to Figure G for Step 8**

Step 8: Using a 10mm socket and ratchet, remove the four (4) bolts (8) on the top of the core support. Retain the hardware for reassembly.



Figure H

Refer to Figure H for Step 9

**Note: Vehicles equipped with the 360-view camera will need to disconnect the wire harness from the camera.**

Step 9: Remove the grille assembly.

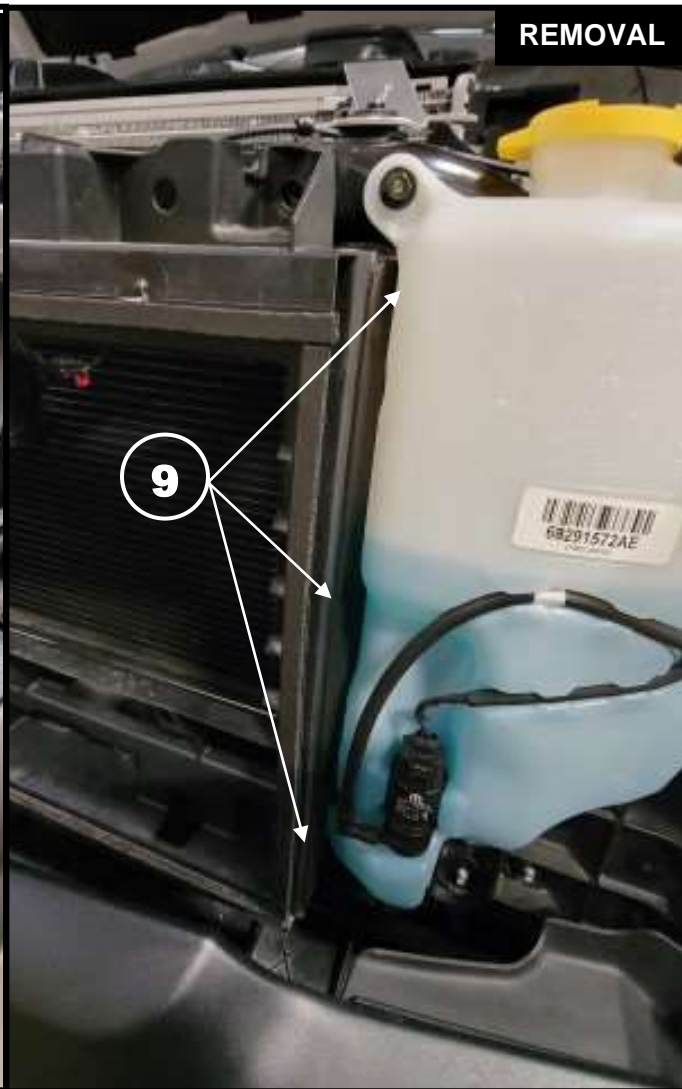
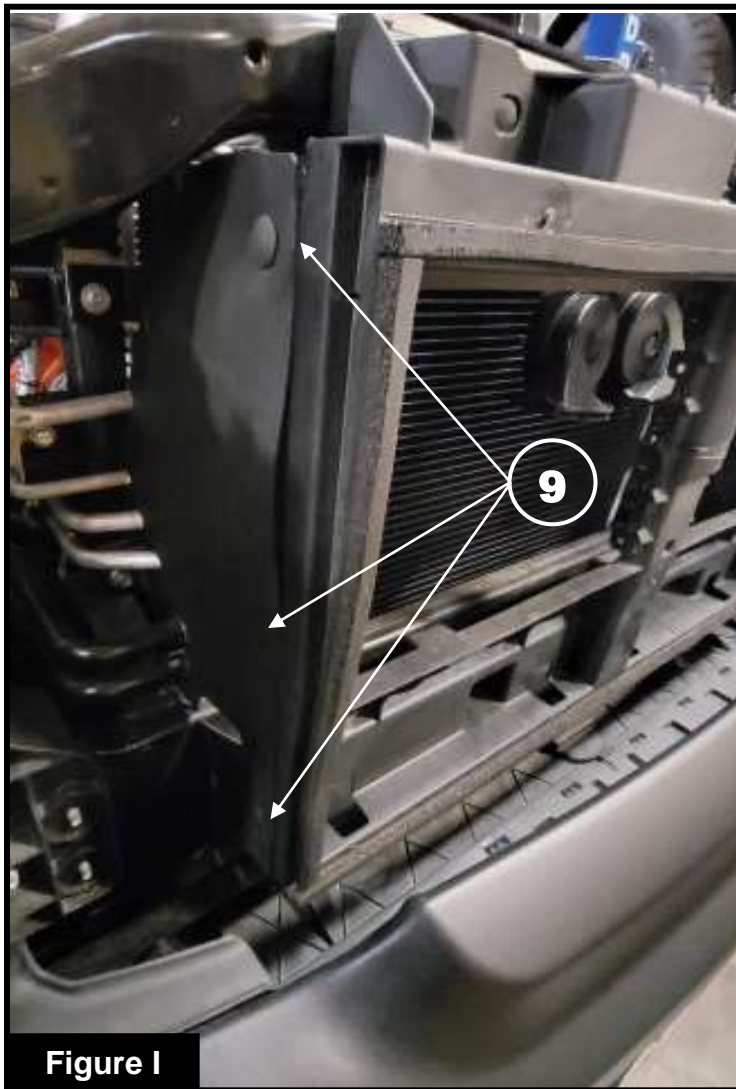

Figure I

**Refer to Figure I for Step 10**

Step 10: Using a small trim removal tool, remove the six (6) push retainers (9) which are on left and the right sides of the active shutter's grille housing.



Figure J

**Refer to Figure J for Step 11**

Step 11: Using a 10mm socket and ratchet, remove the four (4) bolts (10) from the active shutter grille housing.

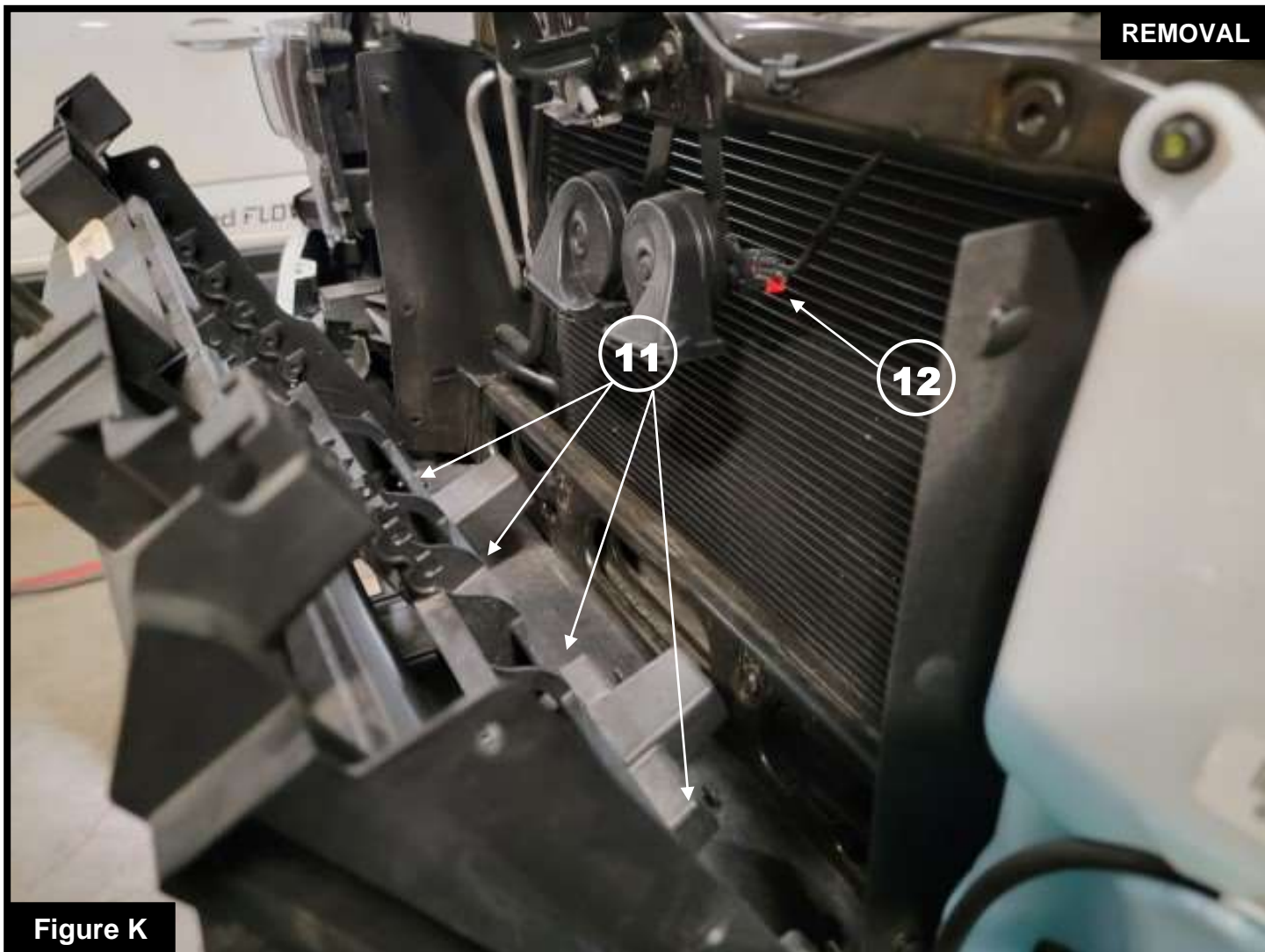

Figure K

**Refer to Figure K for Steps 12-13**

Step 12: Pull down on the top of the active shutter grille housing. Using a small trim removal tool, remove the four (4) push retainers (11) which are on the bottom of the active shutter's grille housing. Remove the active shutter grille housing. Save all the hardware for reassembly.

Step 13: Unplug the electrical connector for the horns. (12)

REMOVAL

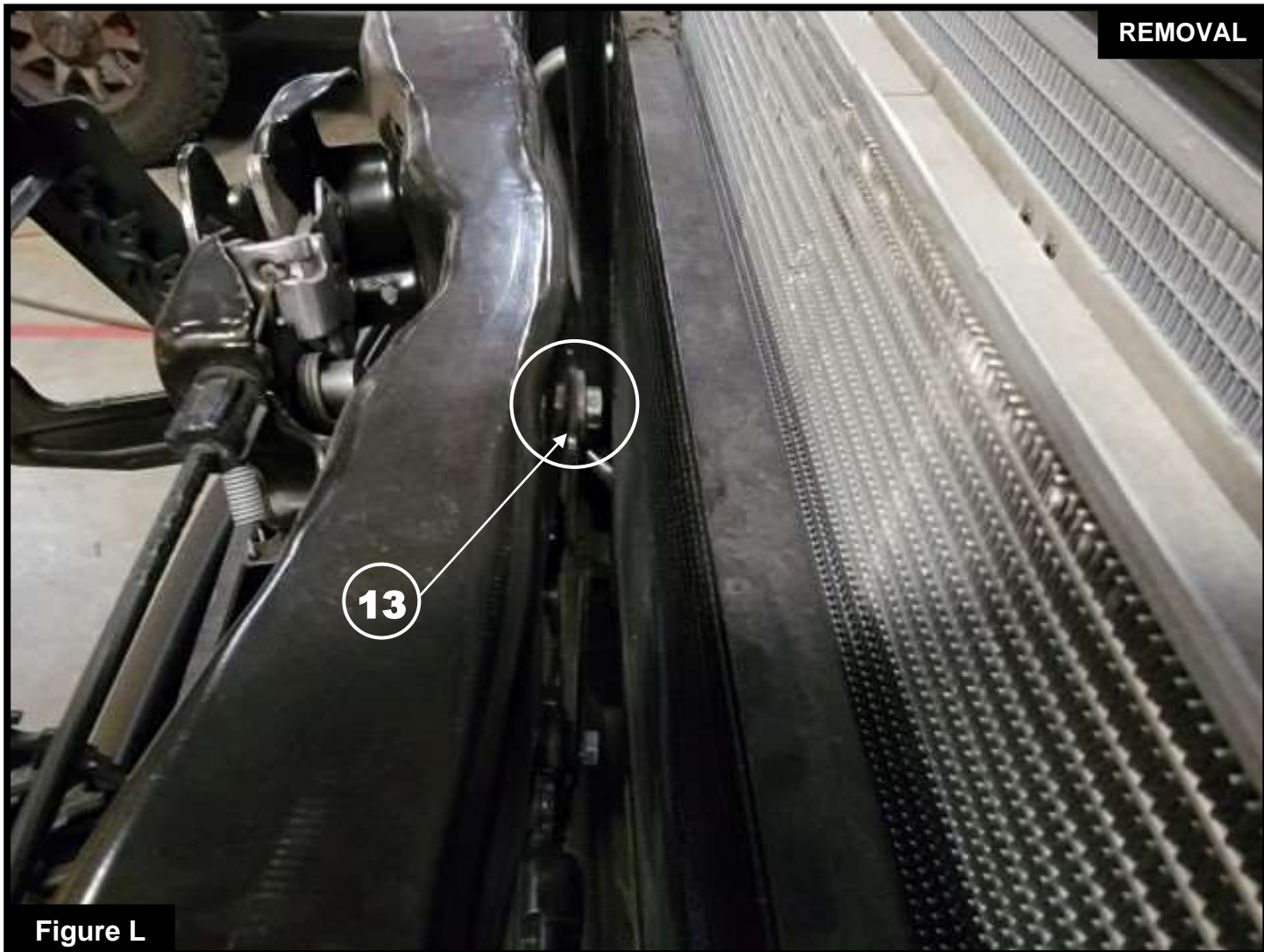

Figure L

**Refer to Figure L for Step 14**

Step 14: Using a 10mm wrench, remove the bolt which holds the horn bracket to the truck. Save the hardware for reassembly. (13)

**Figure M****Refer to Figure M for Step 15**

Step 15: Using a 10mm wrench, remove the nuts which hold the horns to the factory horn brackets. Save the horns and the hardware for reassembly. (14)





**Refer to Figure N for Step 16**

Step 16: Remove the 10mm bolt which holds the transmission cooler lines to the radiator. Save the hardware for reassembly. ⑮

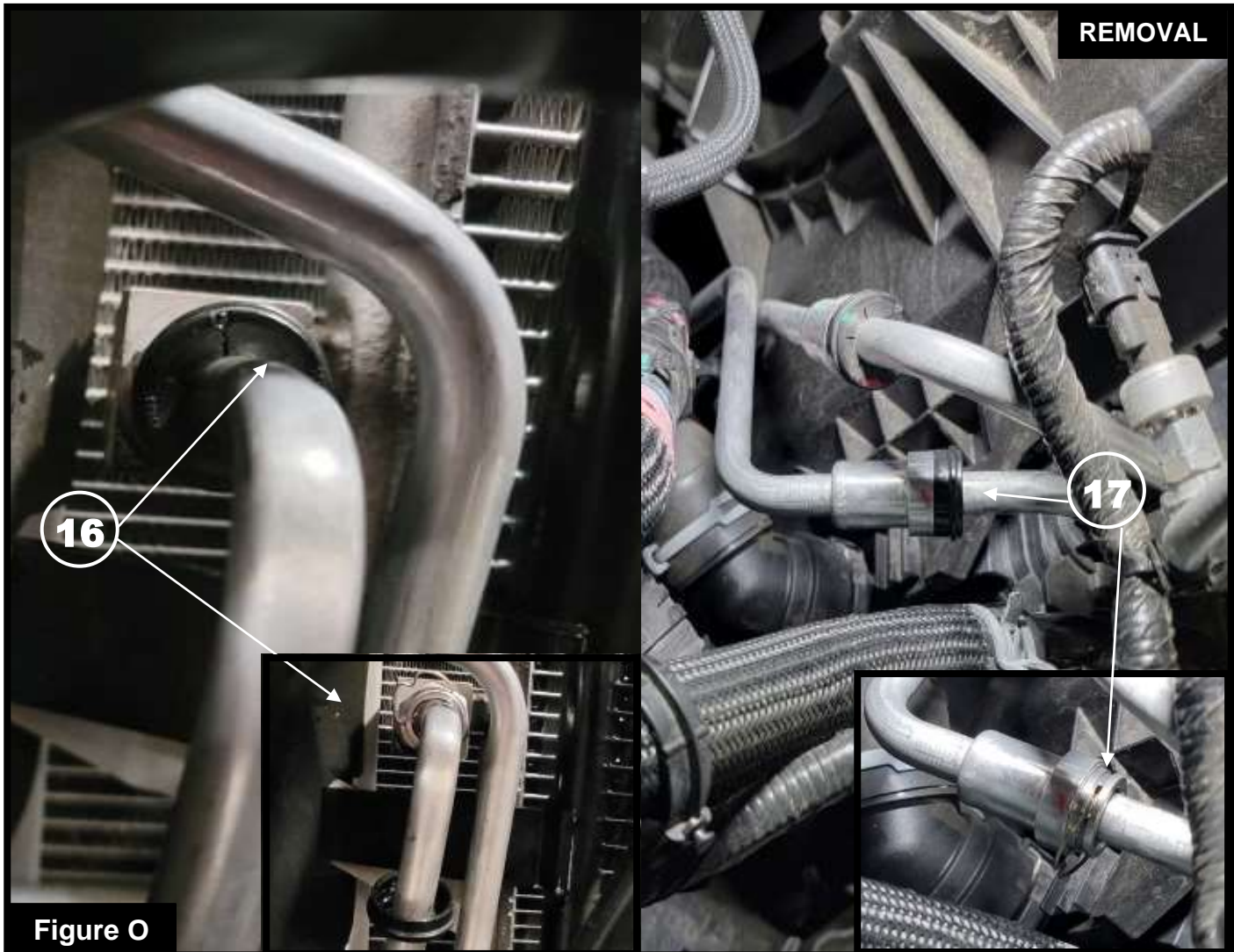

**Refer to Figure O for Steps 17-20**

Step 17: Find the transmission cooler line at the transmission cooler / A/C Condenser. It is located just under the core support on the passenger side.

Step 18: Remove the dust cover off the stock transmission cooler line and remove the quick disconnect clip under it. Pull the transmission cooler line out of the transmission cooler. (16)

Step 19: Find the other end of the transmission cooler line in the engine compartment.

Step 20: Remove the dust cover off the stock transmission cooler line and remove the quick disconnect clip under it. (17) Pull the transmission cooler line out of the union. Save the clip for reassembly.



Figure P

**Refer to Figure P for Step 21**

**Note: Please read this instruction. The factory transmission cooler could be damaged if this step isn't preformed carefully.**

Step 21: Using two wrenches, carefully remove the factory fitting attached to the transmission cooler.

18

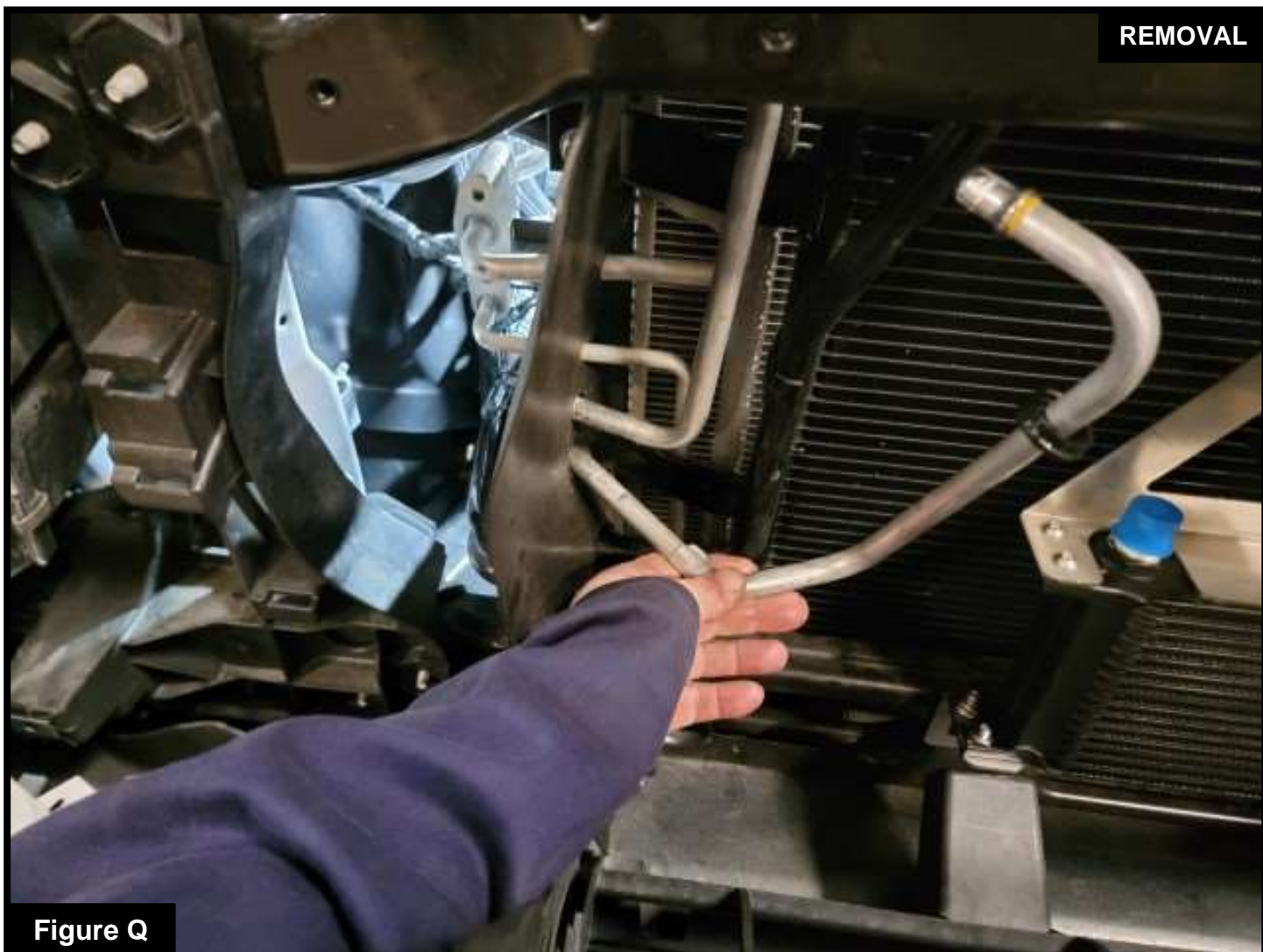

Figure Q

**Refer to Figure Q for Step 22**

Step 22: Remove the transmission line from the truck.



Figure R

**Refer to Figure R for Step 23**

Step 23: Reinstall the factory hardware removed in Step 16 and tighten to factory specifications. (19)

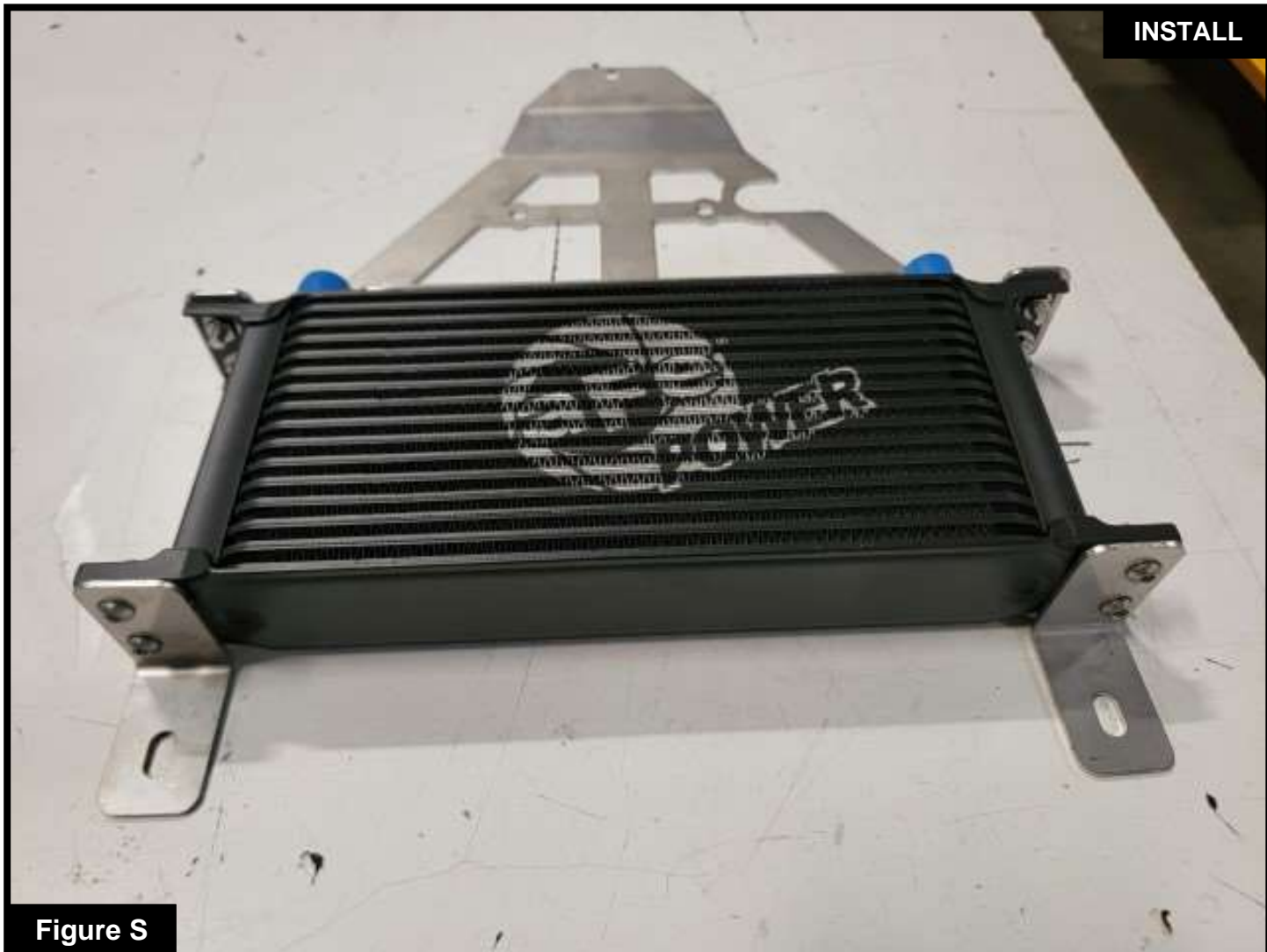
**Figure S****Refer to Figure S for Step 24**

Step 24: Using the parts supplied, assemble the transmission cooler:

- 8 - Button Head M6x20mm
- 8 - M6 Hex Nut
- Lower Mount Bracket – Passenger side
- Lower Mount Bracket – Drivers side
- Upper Mount Bracket
- Oil Cooler

Leave the hardware loose.

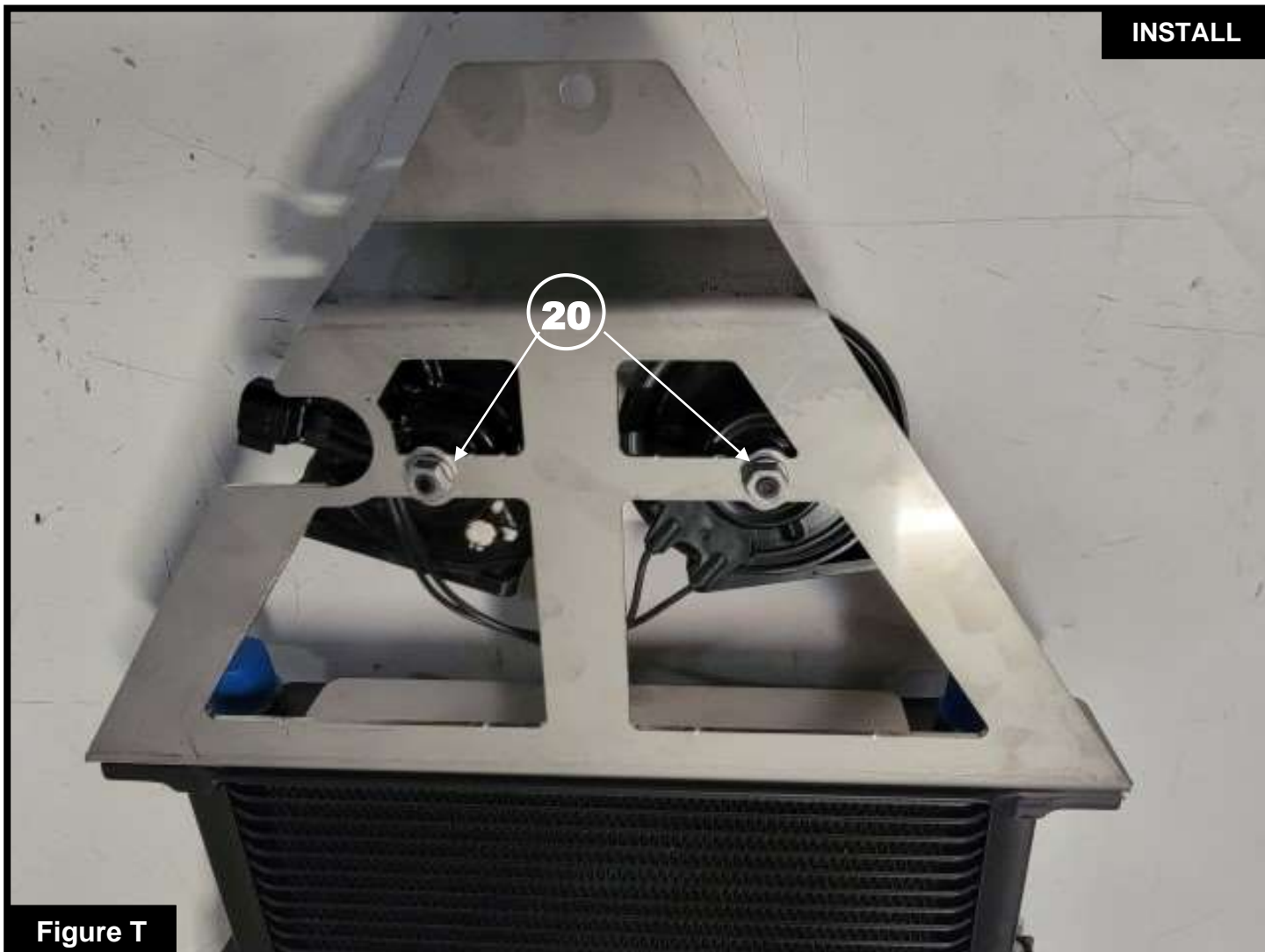
**Figure T****Refer to Figure T for Step 25**

Step 25: Install the factory horns onto the aFe upper mount bracket using the factory hardware and tighten. **20** Torque to factory specifications.

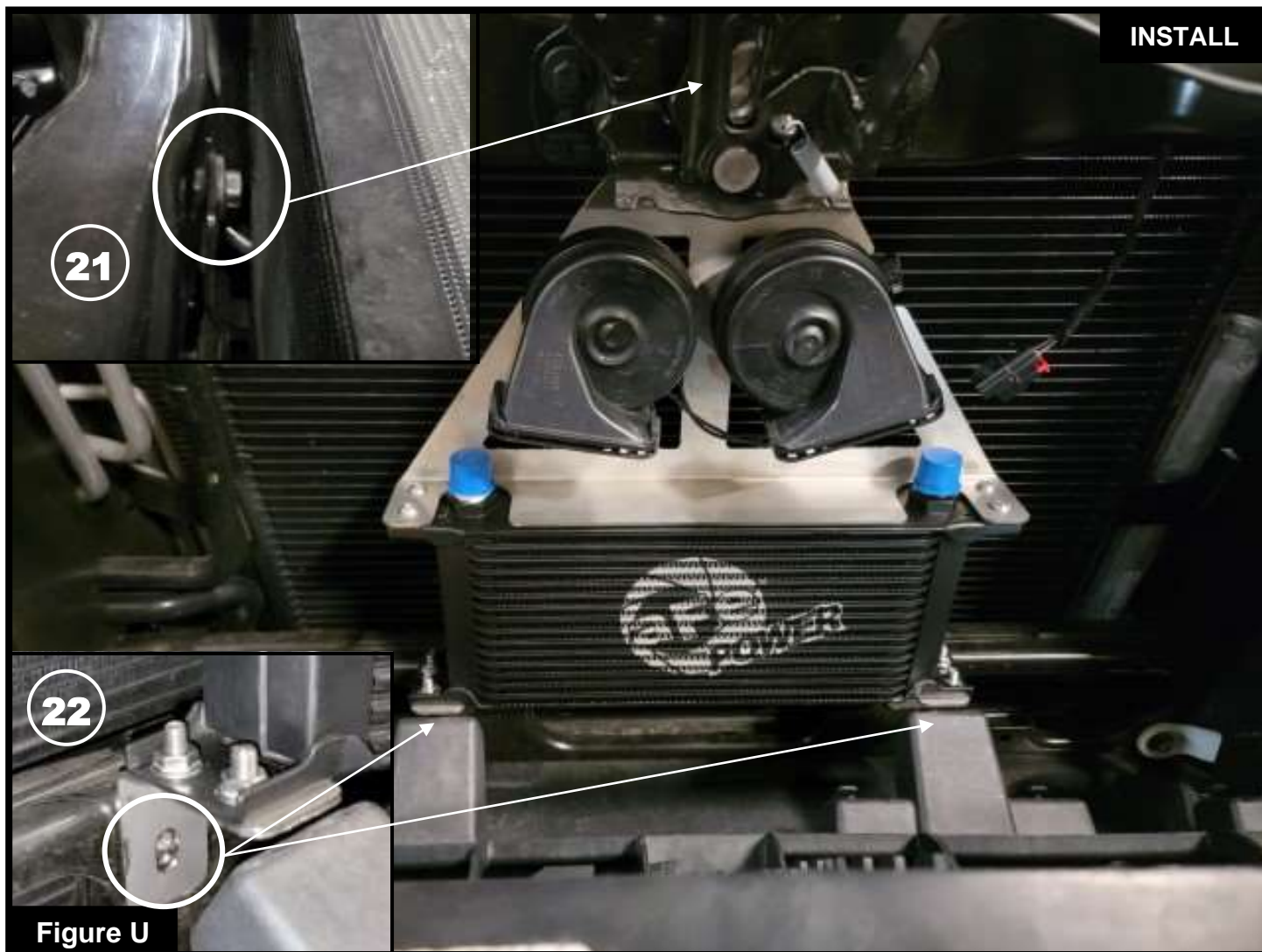

**Refer to Figure U for Step 26**

Step 26: Install the transmission cooler assembly into the truck as shown. The upper bracket will attach to the truck where the factory horn assembly was removed. (21) The lower brackets will rest against the lower core support. (22) Leave all the hardware loose.

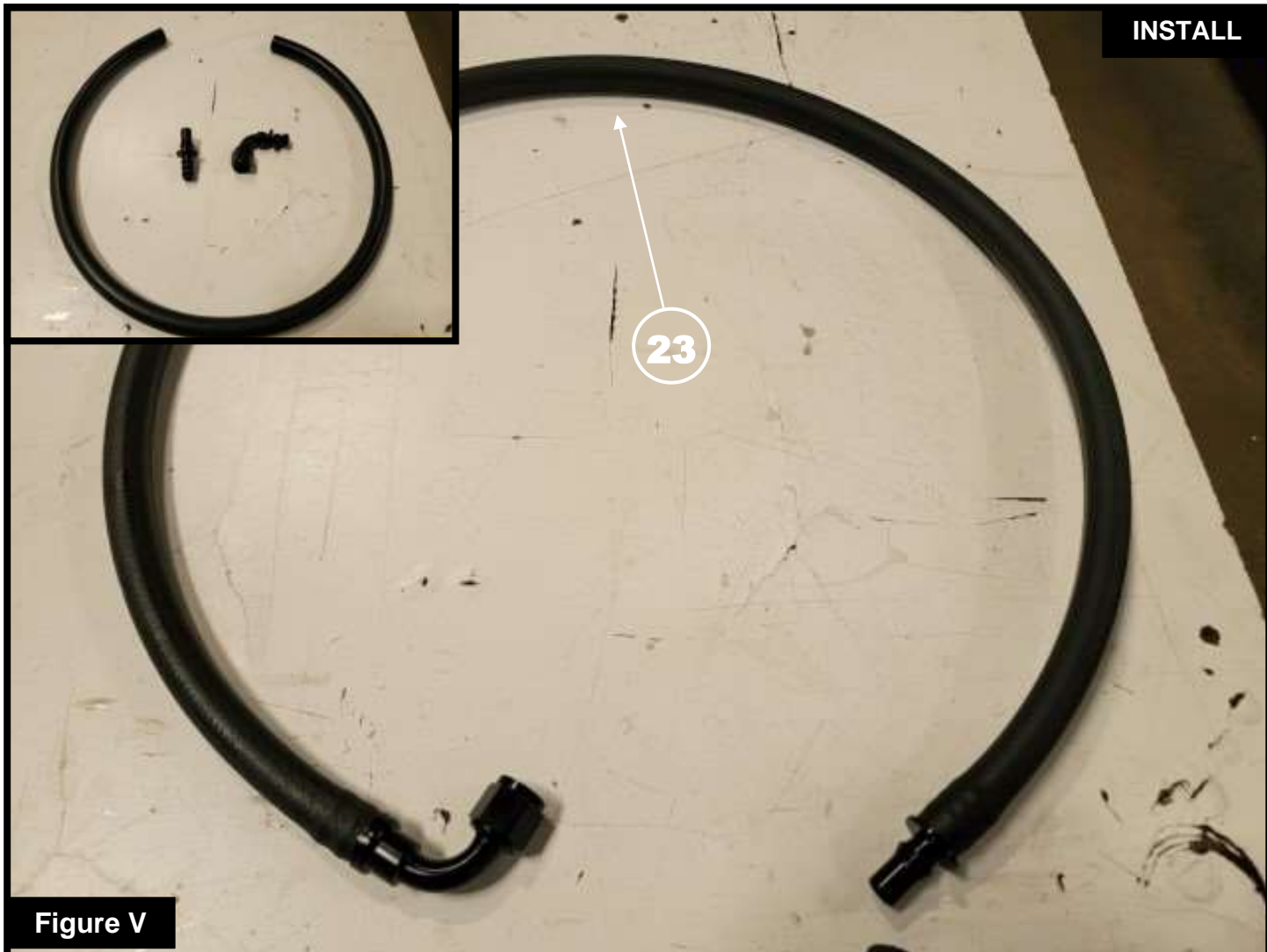

**Figure V****Refer to Figure V for Step 27**

Step 27: Using the supplied parts listed below, assemble the transmission cooler hose shown in Figure V. (23)

- 50.5" Hose
- Fitting 90° push onto AN-8
- Fitting Adaptor, Dodge transmission line adapter

**Figure W****Refer to Figure W for Step 28**

Step 28: Using the supplied parts listed below, assemble the transmission cooler hose shown in Figure W. (24)

- 10" Hose
- 2 - Fitting 90° push onto AN-8

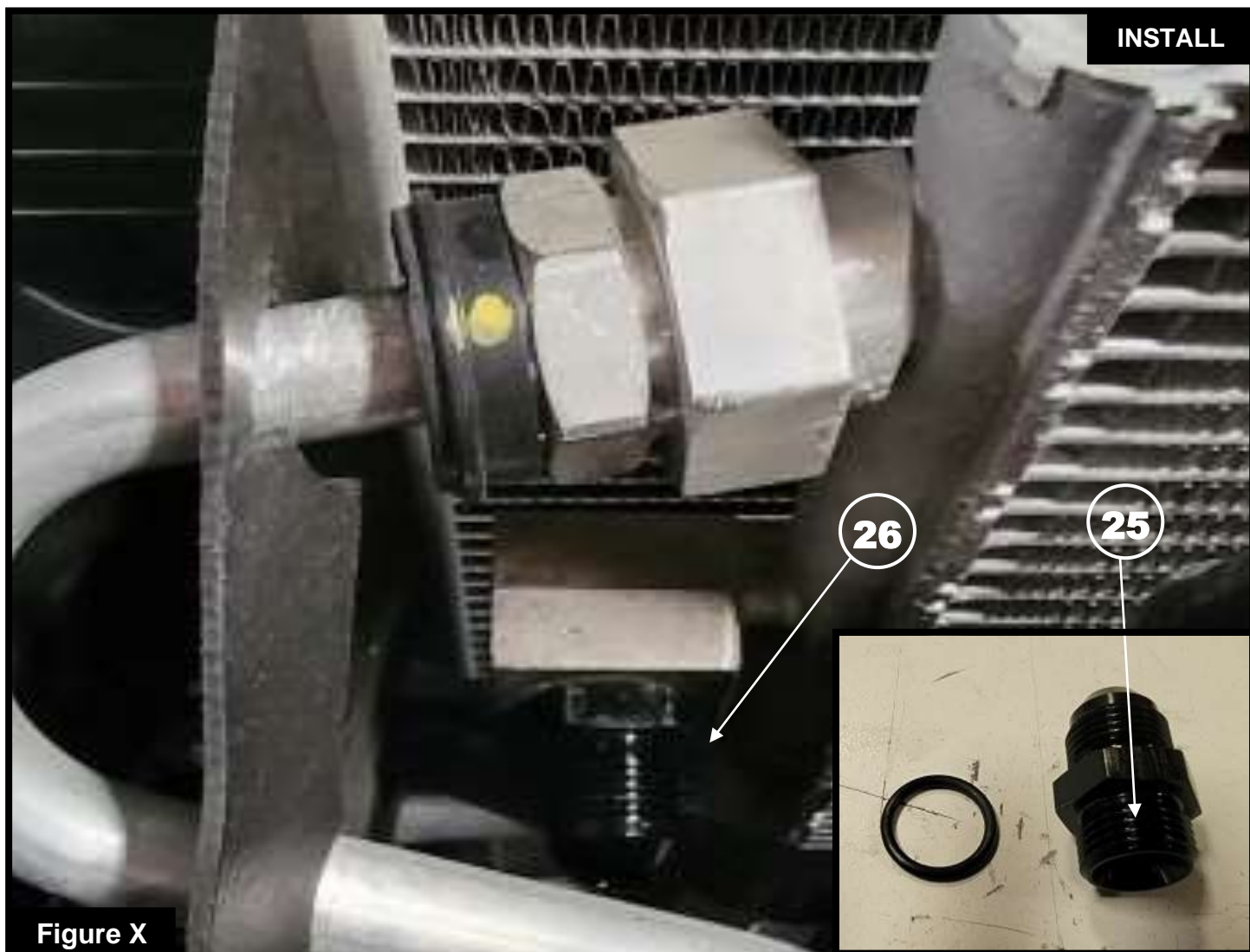

Figure X

**Refer to Figure X for Steps 29-30**

**Note: Please read this instruction. The transmission cooler could be damaged if this step isn't preformed carefully.**

Step 29: Using the supplied parts listed below, Install the O-ring onto the straight threaded side of the fitting. (25)

- Fitting 3/4 - 16 O-Ring to AN - 8
- O-ring

Step 30: Install the supplied fitting into the factory transmission cooler. Tighten using 2 wrenches. (26)

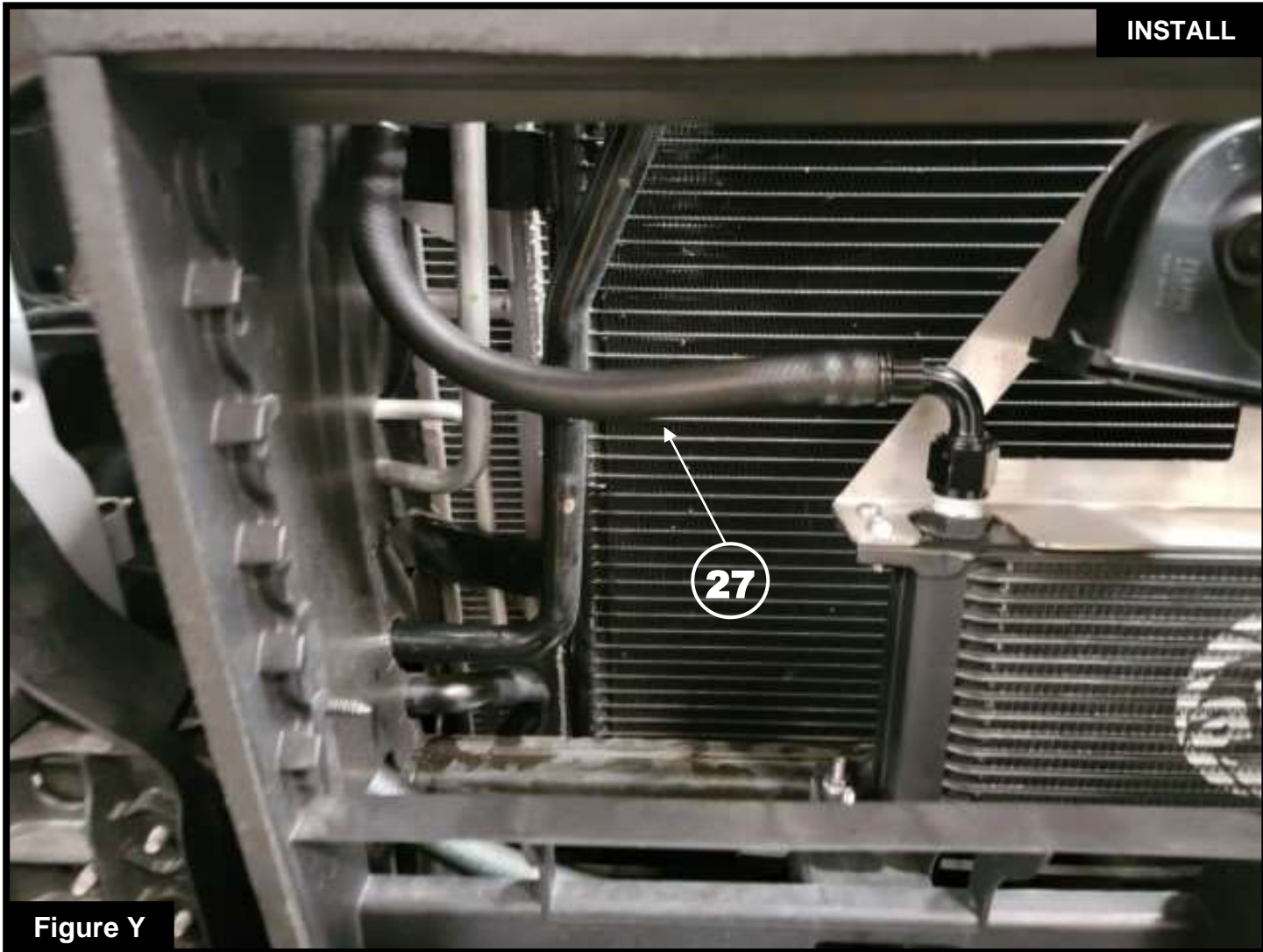
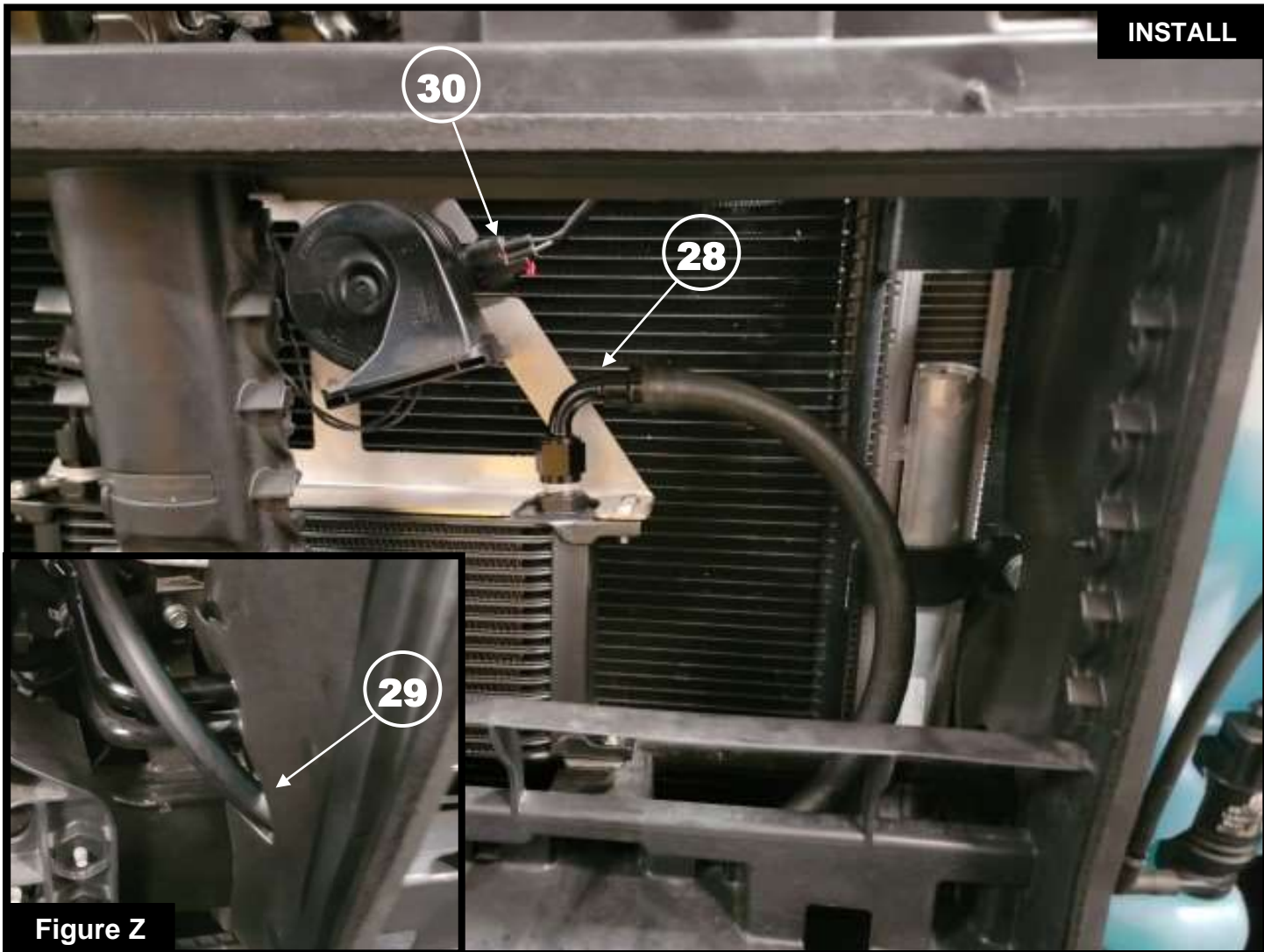

**Figure Y**

**Refer to Figure Y for Steps 31-32**

Step 31: Install the 10" hose onto the factory transmission cooler first. Leave the fitting loose.

Step 32: Install the transmission cooler hose to the passenger side of the aFe transmission cooler.  
Torque both fittings to 23 ft. lbs. (27)

**Figure Z****Refer to Figure Z for Steps 33-34**

Step 33: Install the 50.5" hose onto the drivers side of the aFe transmission cooler. Leave the fitting loose. (28) Route the hose under the aFe transmission cooler and out the passenger side of the active shutter grille housing shroud. (29)

Step 34: Reconnect the electrical connector for the horns. (30)



**Refer to Figure AA for Steps 35-36**

Step 35: Reinstall the quick disconnect clip back into the factory power steering line. Route the aFe 50.5" transmission cooler line through the core support, following the factory transmission cooler line, (31) and push the fitting adapter into the factory transmission cooler line union that was disconnected in Step 20. (32)

Step 36: Tighten and torque the 90° fitting on the driver's side fitting of the aFe transmission cooler to 23 ft. lbs.

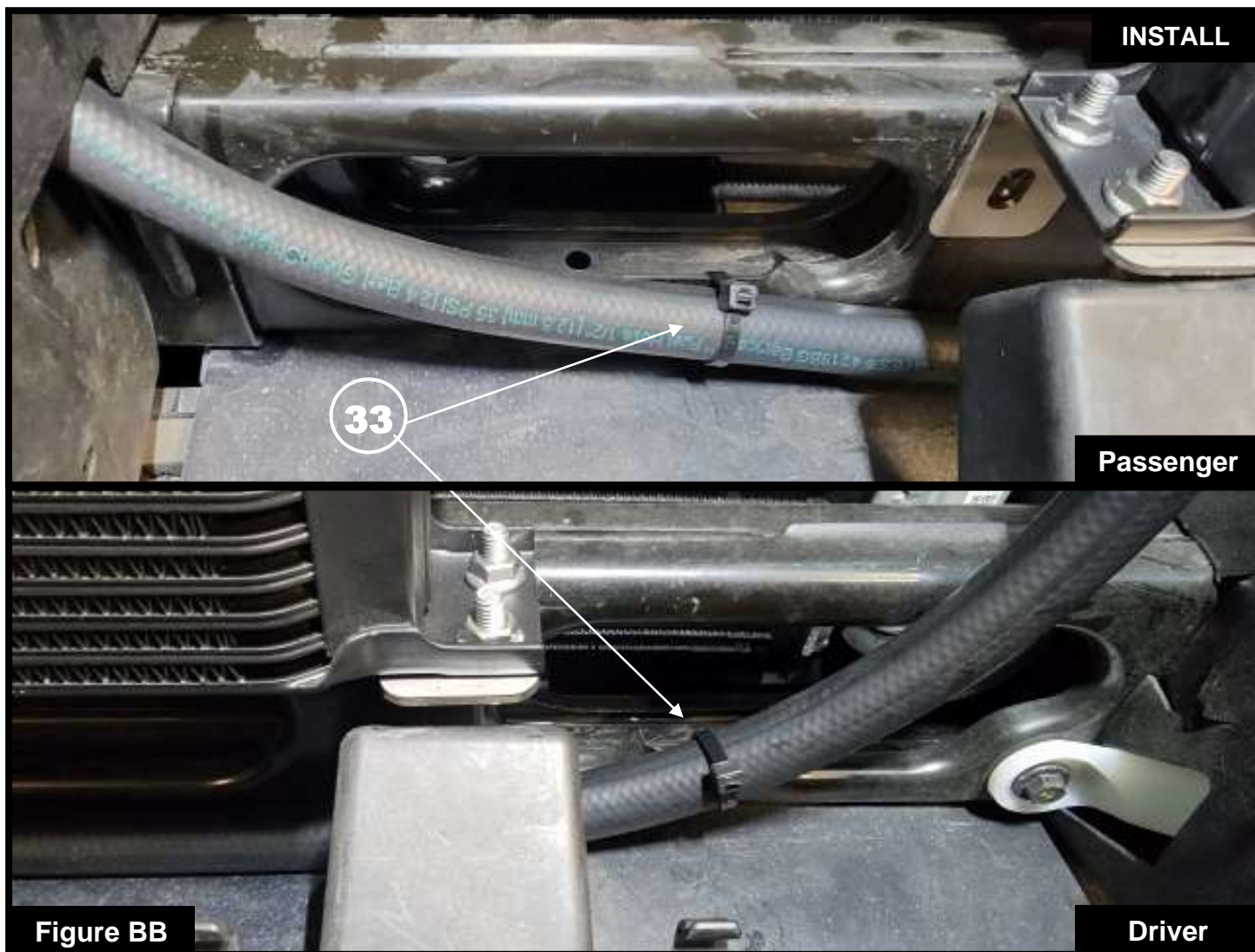

**Refer to Figure BB for Step 37**

Step 37: Install two (2) supplied nylon cable ties to the 50.5" transmission cooler hose and attach it to the core support. (33)

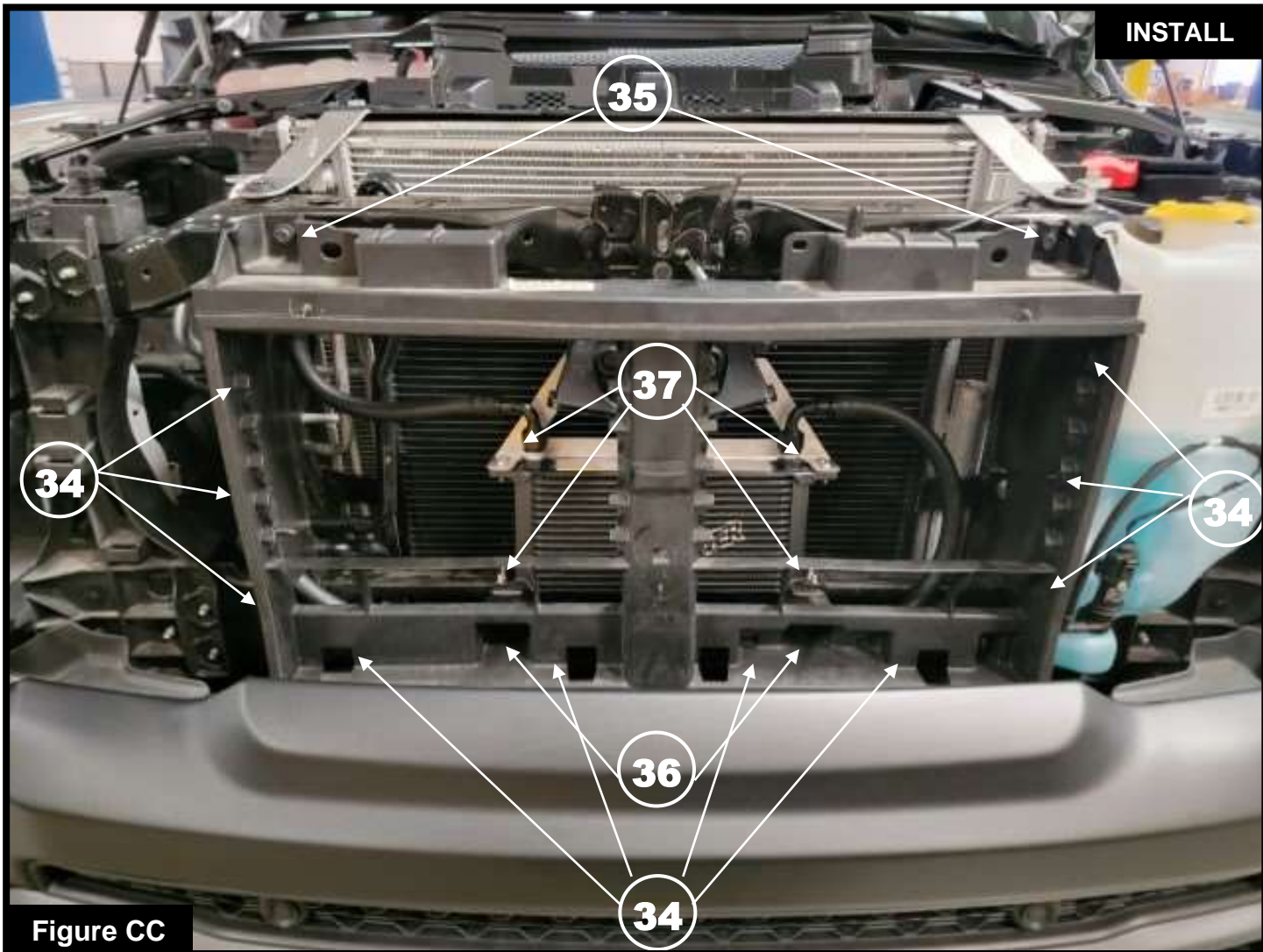

Figure CC

**Refer to Figure CC for Steps 38-41**

Step 38: Place the active shutter grille housing into the truck. Push the push pins back in that were removed in Step 10 and Step 12. (34) Line up the bolts holes on the top of the core support and start the two (2) bolts on the top. (35)

Step 39: Line up the bottom bolt holes on the active shutter grille housing with the brackets on the aFe cooler and threaded holes in the core support. (36) Install the two (2) factory bolts. Leave loose at this time.

Step 40: Tighten the eight (8) supplied hardware on the aFe transmission cooler. (37)

Step 41: Tighten the four (4) factory hardware on the active shutter grille housing to factory specifications. (35) (36)





**Refer to Figure DD for Step 42**

**Note: Vehicles equipped with the 360-view camera will need to reconnect the wire harness for the camera.**

Step 42: Reinstall the factory grille. Using a 10mm socket and ratchet, reinstall the four (4) bolts (38) on the top of the core support removed in Step 8. Tighten to factory specifications.

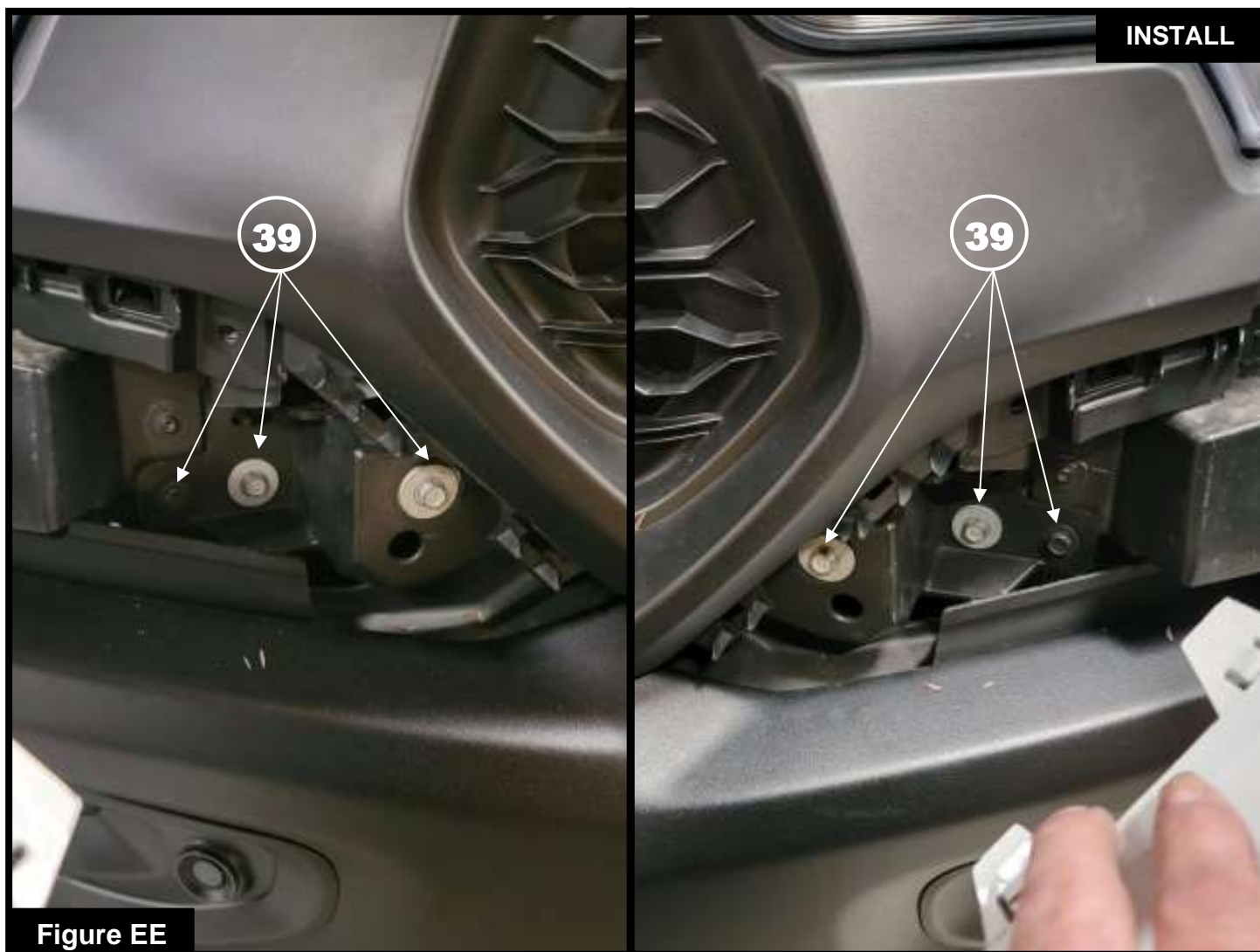
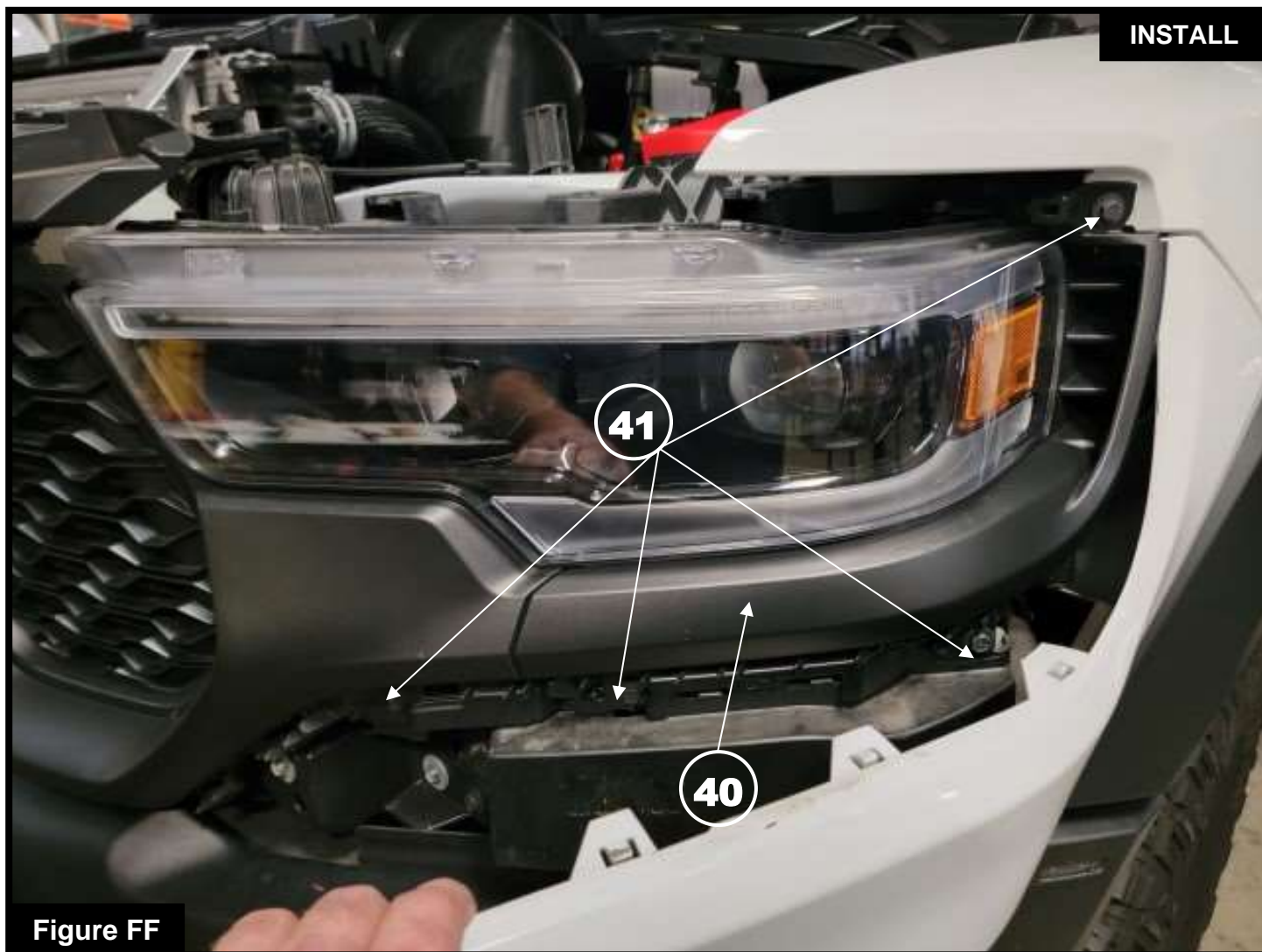

Figure EE

**Refer to Figure EE for Step 43**

Step 43: Install the six (6) bolts (39) under the grille assembly removed in Step 7. Tighten to factory specifications.



**Refer to Figure FF for Step 44**

Step 44: Install the headlight trim pieces (40) and the eight (8) bolts (41) to the grille assembly removed in Step 6. Tighten to factory specifications.



**Figure GG**

**Refer to Figure GG for Step 45**

Step 45: Using your hands, push on the fascia trim to resecure them to the grille assembly.

**Figure HH****Refer to Figure HH for Steps 46-47**

Step 46: Reinstall the header assembly back onto the truck

Step 47: Using a 10mm socket and ratchet, reinstall the eight (8) 10mm bolts (42) and the two (2) push clips (43) removed in Step 3. Tighten to factory specifications.



**Refer to Figure II for Steps 48-49**

**INSTALL**

Step 48: Reinstall the close out panel.

Step 49: Secure the close out panel to the truck with the sixteen (16) push clips (44) removed from Step 2.



**Refer to Figure JJ for Step 50**

**INSTALL**

Step 50: Reinstall your engine cover. (45)

**Figure KK****Refer to Figure KK for Steps 51-54**

Step 51: Remove the Lower Skid plate and the clean the oil lost from the installation of the oil cooler.

Step 52: Reinstall the skid plate and tighten the hardware to factory specifications.

Step 53: Use the proper factory procedure to check the transmission fluid level, top off if needed.

Step 54: Installation is now complete.

**Note: Be sure to check all connections after 50/100 miles.**





**This Page Was Left Intentionally Blank**



**This Page Was Left Intentionally Blank**



**This Page Was Left Intentionally Blank**



advanced FLOW engineering, inc.

252 Granite Street Corona, CA 92879  
TEL: 951.493.7100 • TECH: 951.493.7185



E-Mail: [Tech@aFepower.com](mailto:Tech@aFepower.com)