

advanced FLOW engineering

Cold Air Intake System

Instruction Manual P/N: 57-10026D/ 57-10026R

Make: BMW

Model: Z4 30i (G29)

Year: 2019-2023

Engine: L4-2.0L (t) B48

Make: Toyota

Model: Supra (A90)

Year: 2021-2023

Engine: L4-2.0L (t) B48



- Please read the entire instruction manual before proceeding.
- Ensure all components listed are present.
- For technical support please call at 951-493-7185.
- Ensure you have all necessary tools before proceeding.
- Do not attempt to work on your vehicle when the engine is hot.
- Retain factory parts for future use.

Label	Qty.	Description	Part Number
A	1	Air Filter (Pro DRY S) for 57-10026D	27-90203D
A	1	Air Filter (Pro 5R) for 57-10026R	27-90203R
B	1	Tube, Carbon Fiber	05-5710026C1
C	1	Housing	05-5710017B2
D	1	Coupling, Silicone Bellows: 3"ID x 2-1/2"L w/ IB	05-01598
E	2	Clamp, #048	03-50007
F	1	Seal, Trim: 13/32" Dbl. Bulb, 34" Length	05-01534
G	2	Screw, M4	03-50491

Installation will require the following tools:

Socket set, socket wrench, flat-head screwdriver, T20 torx bit.

Warranty information available at <https://afepower.com/contact#warranty>.

Emissions Disclaimer:

This product is not currently CARB exempt and is not available for purchase in California or for use on any vehicle registered with the California Department of Motor Vehicles.

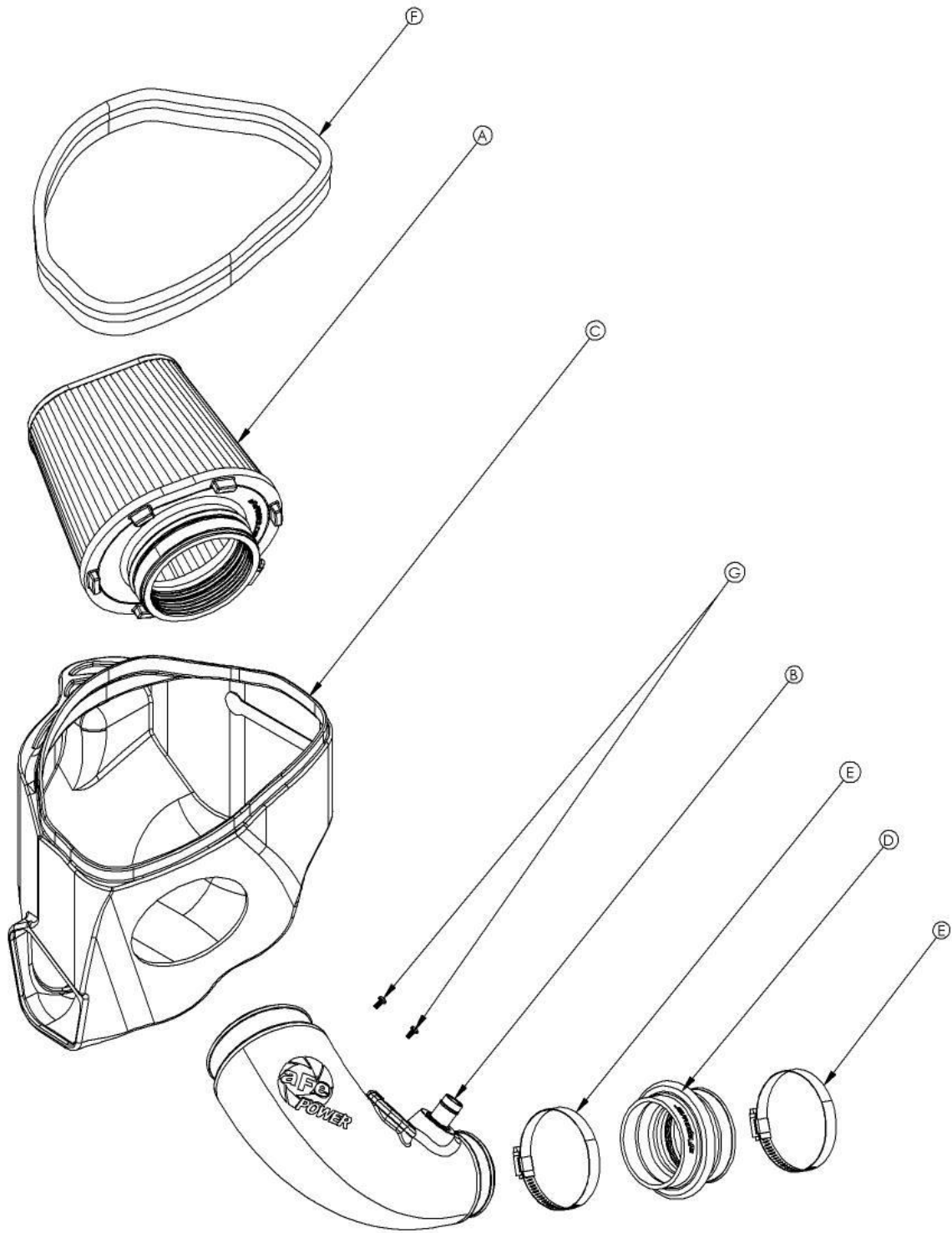

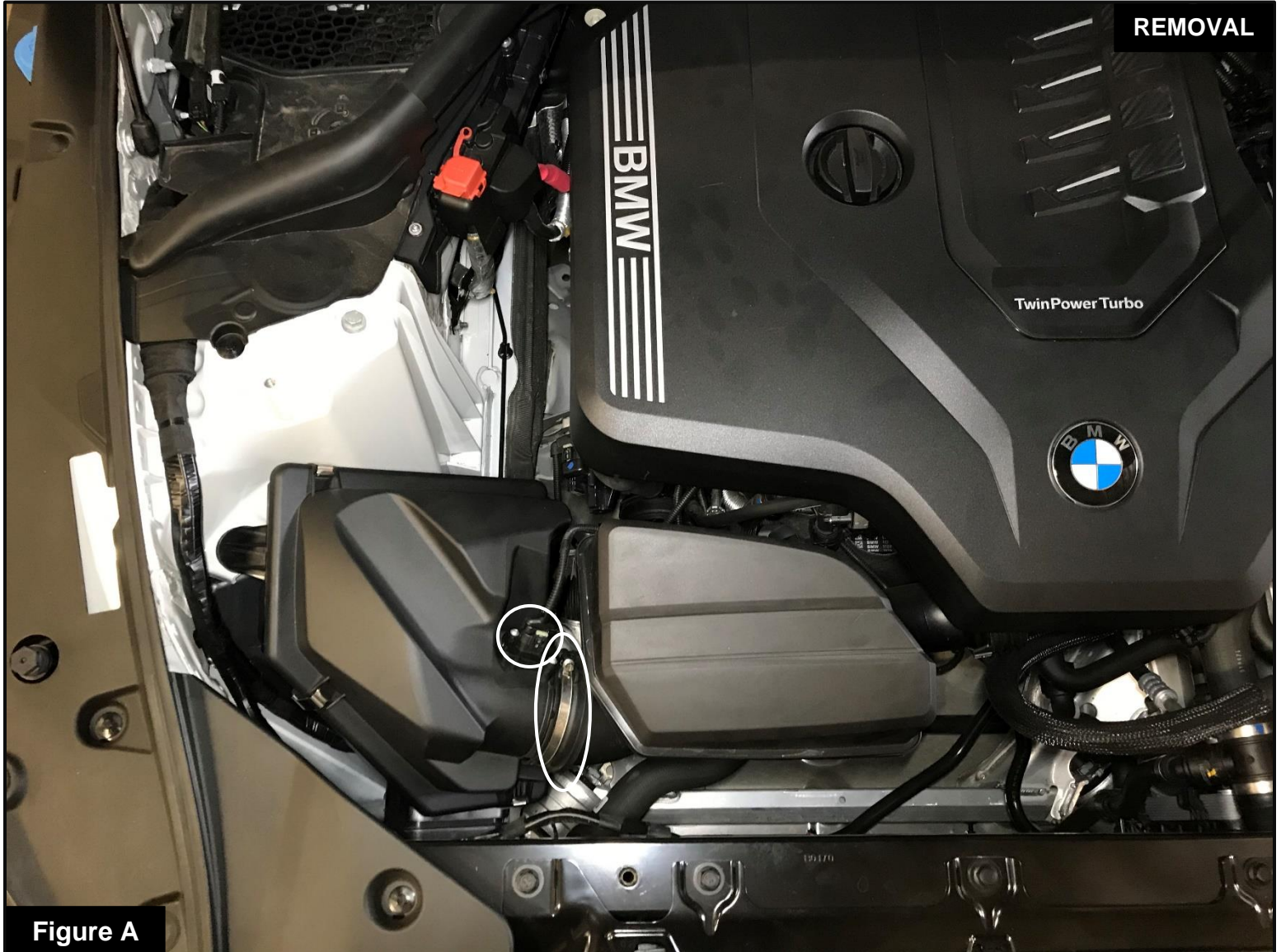

Figure A

Refer to Figure A for Steps 1-4

Step 1: If the vehicle is equipped with a brace above the factory intake, remove the brace.

Step 2: Disconnect the temperature sensor harness.

Step 3: Loosen the hose clamp at the factory airbox. Then, slide the factory intake tube away from the factory airbox.

Step 4: To remove the factory airbox, carefully and firmly pull up on the factory airbox.

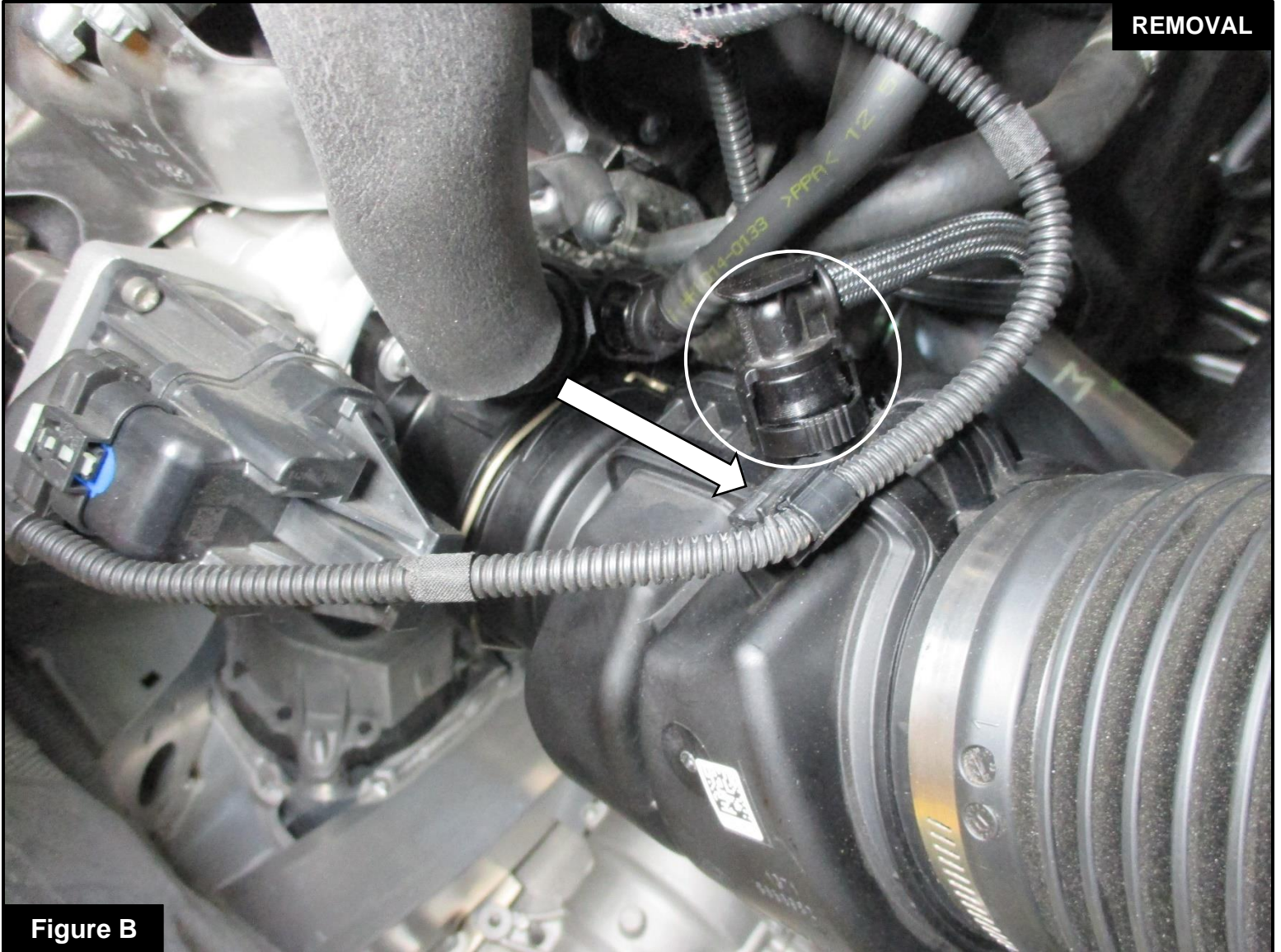
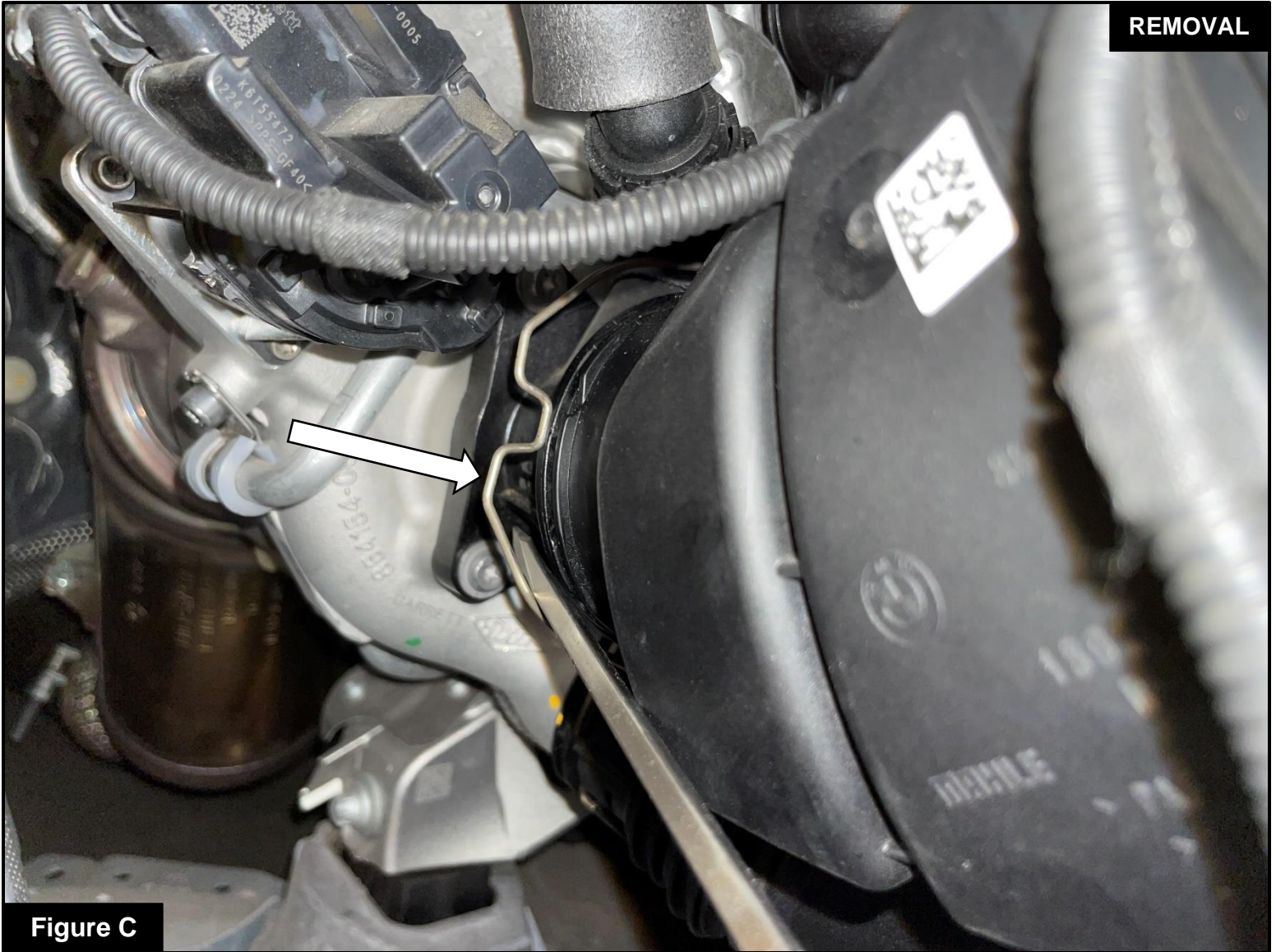

Figure B

Refer to Figure B for Steps 5-6

Step 5: Disconnect the crankcase breather line.

Step 6: Detach the harness clip from the factory intake tube

**Figure C****Refer to Figure C for Step 7**

Step 7: Carefully remove the retention ring holding the factory intake tube to the turbo inlet and pull the factory intake tube out of the vehicle.



Figure D

Refer to Figure D for Step 8

Step 8: Transfer the temperature sensor from the factory airbox to the carbon fiber aFe POWER intake tube and attach with the supplied screws.

**Figure E****Refer to Figure E for Steps 9-11**

Step 9: Install the supplied air filter into the aFe POWER housing. Place the air filter into the large opening at the top, then slip the air filter flange into the round opening on the aFe POWER housing, making sure the air filter's lip locks into place. Rotate the air filter to have clearance around the inside of the aFe POWER housing.

Step 10: Place the clamp over the flange of the air filter. Do not tighten the clamp at this time.

Step 11: Install the supplied trim seal on the top edge of the aFe POWER housing.

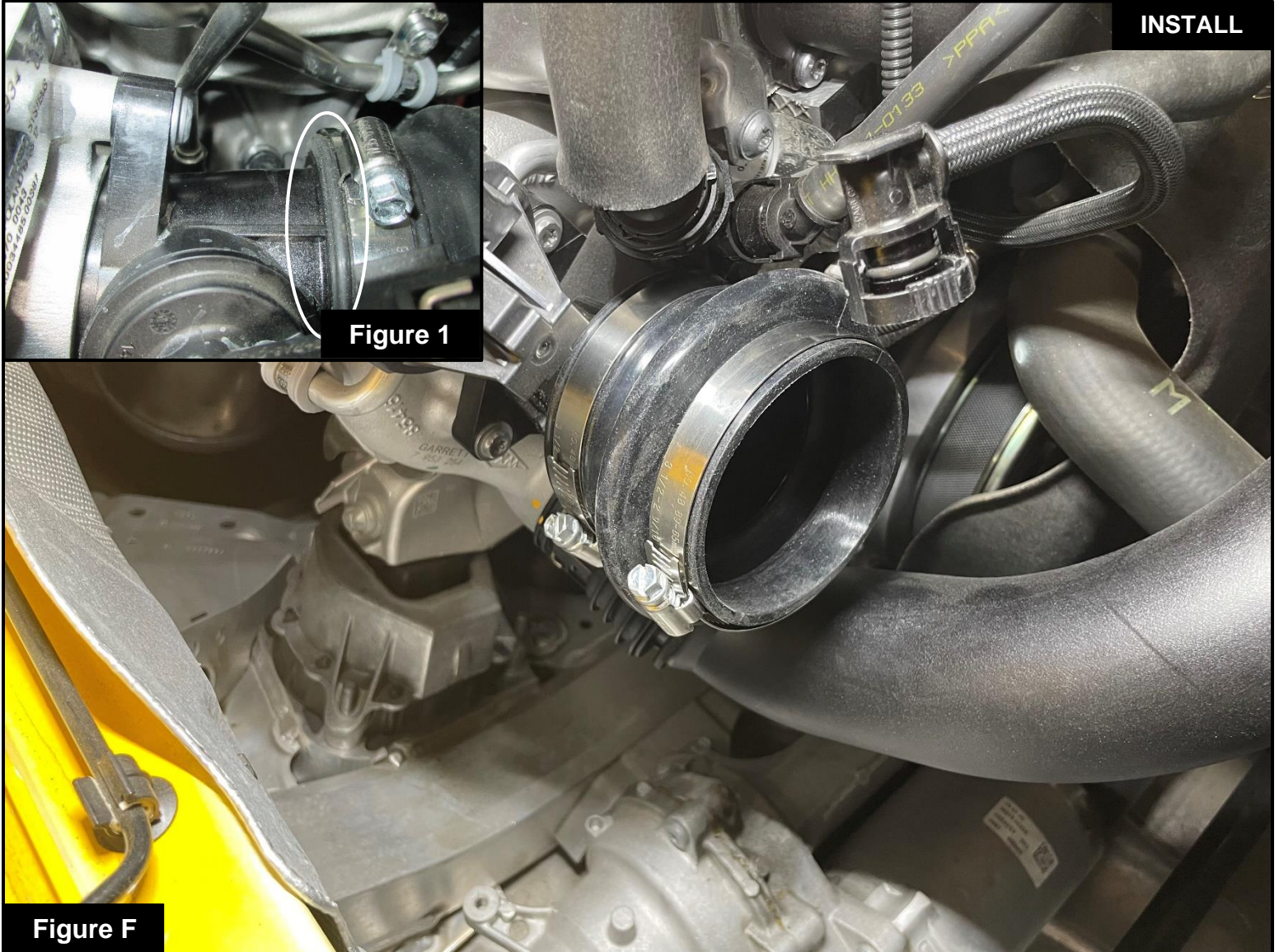

Refer to Figure F for Steps 12-14

- Step 12: Install the supplied coupling onto the turbo inlet and place the supplied clamps onto the coupling.
- Step 13: Make sure to have the end of the coupling sit flush to the rim of the turbo inlet. This is to make sure the interior lip of the coupling sits correctly in the groove of the turbo inlet. See **Figure 1**.
- Step 14: When the coupling sits correctly on the turbo inlet, tighten the clamp between the coupling and the turbo inlet. Do not tighten the coupling at the open end of the coupling.

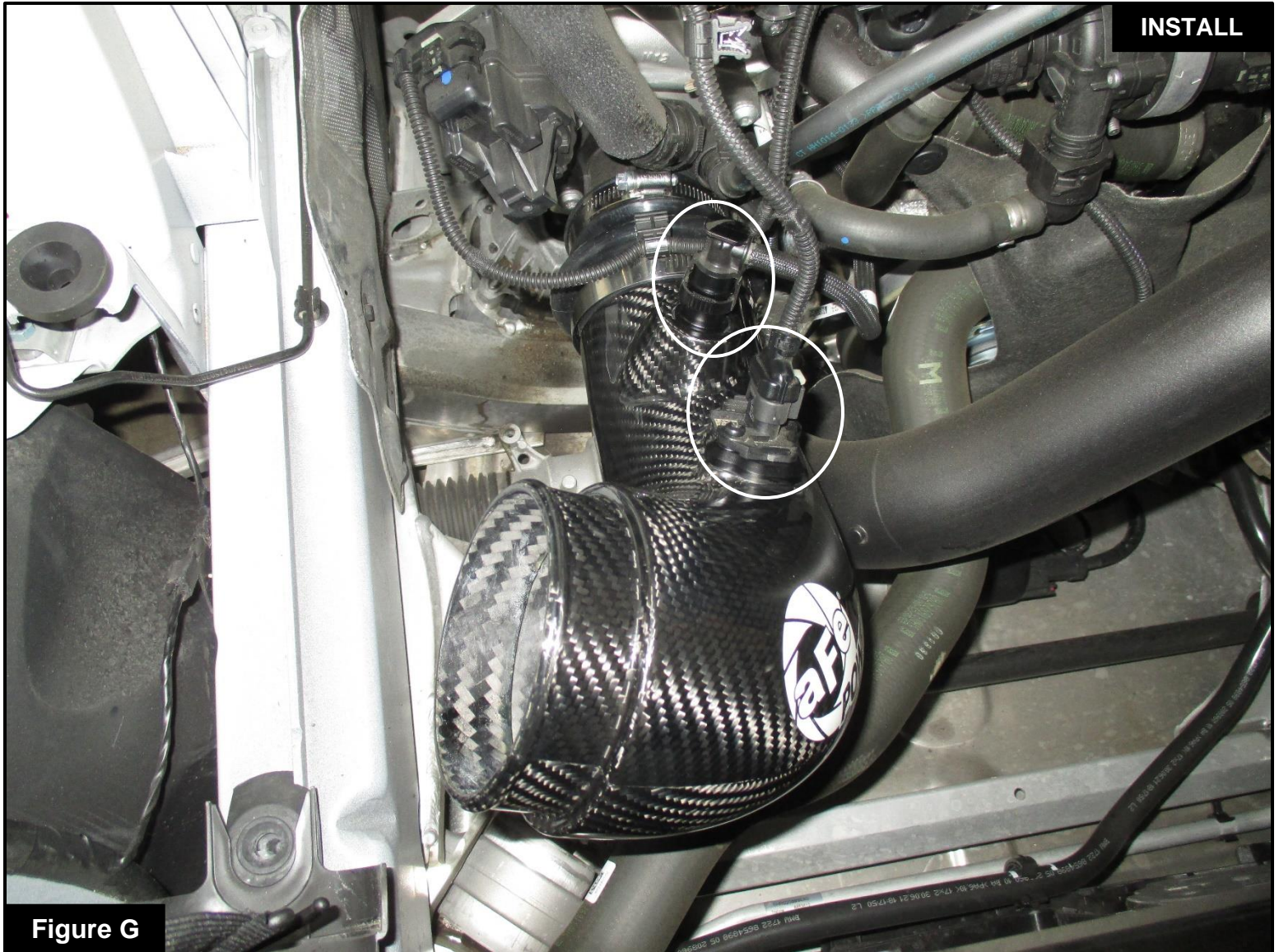

Figure G

Refer to Figure G for Steps 15-18

- Step 15: Install the carbon fiber aFe POWER intake tube into the coupling. Do not tighten the clamp at this time.
- Step 16: Connect the crankcase breather line to the carbon fiber aFe POWER intake tube.
- Step 17: Connect the temperature sensor harness to the temperature sensor.
- Step 18: Make sure the carbon fiber aFe POWER intake tube and crankcase line sit comfortably, then tighten the clamp between the carbon fiber aFe POWER intake tube and the coupling.

**Figure H**

Refer to Figure H for Steps 19-22

Step 19: Install the assembled aFe POWER housing and air filter into the engine bay by pressing down firmly into the three (3) factory mounting grommets.

Step 20: Slip the carbon fiber aFe POWER intake tube into the air filter and tighten the clamp between the carbon fiber aFe POWER intake tube and air filter.

Step 21: If the vehicle is equipped with a brace, re-install the brace from **Step 1**.

Step 22: Make sure all components and connections are secure. Your installation is now complete. Thank you for choosing aFe POWER!

NOTE: Check all bolts, clamps, and connectors after 100-200 miles.

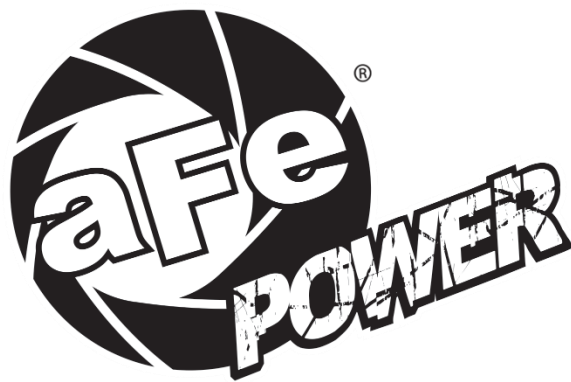

advanced FLOW engineering, inc.

Corona, CA 92879

<https://afepower.com/contact>