

GT
MOMENTUM™

advanced FLOW engineering Cold Air Intake System

Instruction Manual P/N: 50-70075D / 50-70075R

Make: RAM

Model: 1500 TRX

Year: 2021-2023

Engine: V8-6.2L (sc)



- Please read the entire instruction manual before proceeding.
- Ensure all components listed are present.
- For technical support please call 951-493-7185.
- Ensure you have all necessary tools before proceeding.
- Do not attempt to work on your vehicle when the engine is hot.
- Retain factory parts for future use.

Label	Qty.	Description	Part Number
A1	2	Air Filter (Pro 5R)	24-91136
A2	2	Air Filter (Pro DRY S)	21-91136
B	1	Housing	05-5070075B4
C	1	Tube #1	05-5070075B1
D	1	Tube #2 (DS)	05-5070075B2
E	1	Tube #3 (PS)	05-5070075B3
F	1	Coupling, Silicone Reducer: 108mm x 100mm x 3"L	05-01703
G	2	Coupling, Silicone Straight: 108mm x 2.25"L	05-01707
H	5	Clamp, T-Bolt (4-5/16" – 4-5/8")	03-50499
J	1	Clamp, T-Bolt (4-1/16" – 4-3/8")	03-50262
K	1	Grommet, Rubber 1"	03-50167
M	1	Fitting, Air Temperature Sensor	05-01454
N	4	Bumper, Rubber: 1/2" ID x 1" OD	03-50769
P	2	Screw, Engraved aFe POWER: M6 x 1.0mm	03-50483
Q	2	Grommet, Rubber 5/8"	03-50076
R	2	Spacer, AL: 7/16" x 1/2"	03-50772
S	2	Push Clip: 6.5mm x 22mm	03-50773
T	1	Hose, Silicone Breather: 1/2" ID, Black (10" L)	03-01396

Installation will require the following tools:

Trim removal tool, Ratchet, 12" Ratchet Extension, 10mm, 13mm, 8mm sockets, 11mm deep socket, T30 Torx driver, Razor blade, 1/2" Drill bit, Drill, 3mm Allen key

Warranty Information available at <https://afepower.com/contact#warranty>

Emissions Disclaimer: This product is not currently CARB exempt and is not available for purchase in California or for use on any vehicle registered with the California Department of Motor Vehicles.

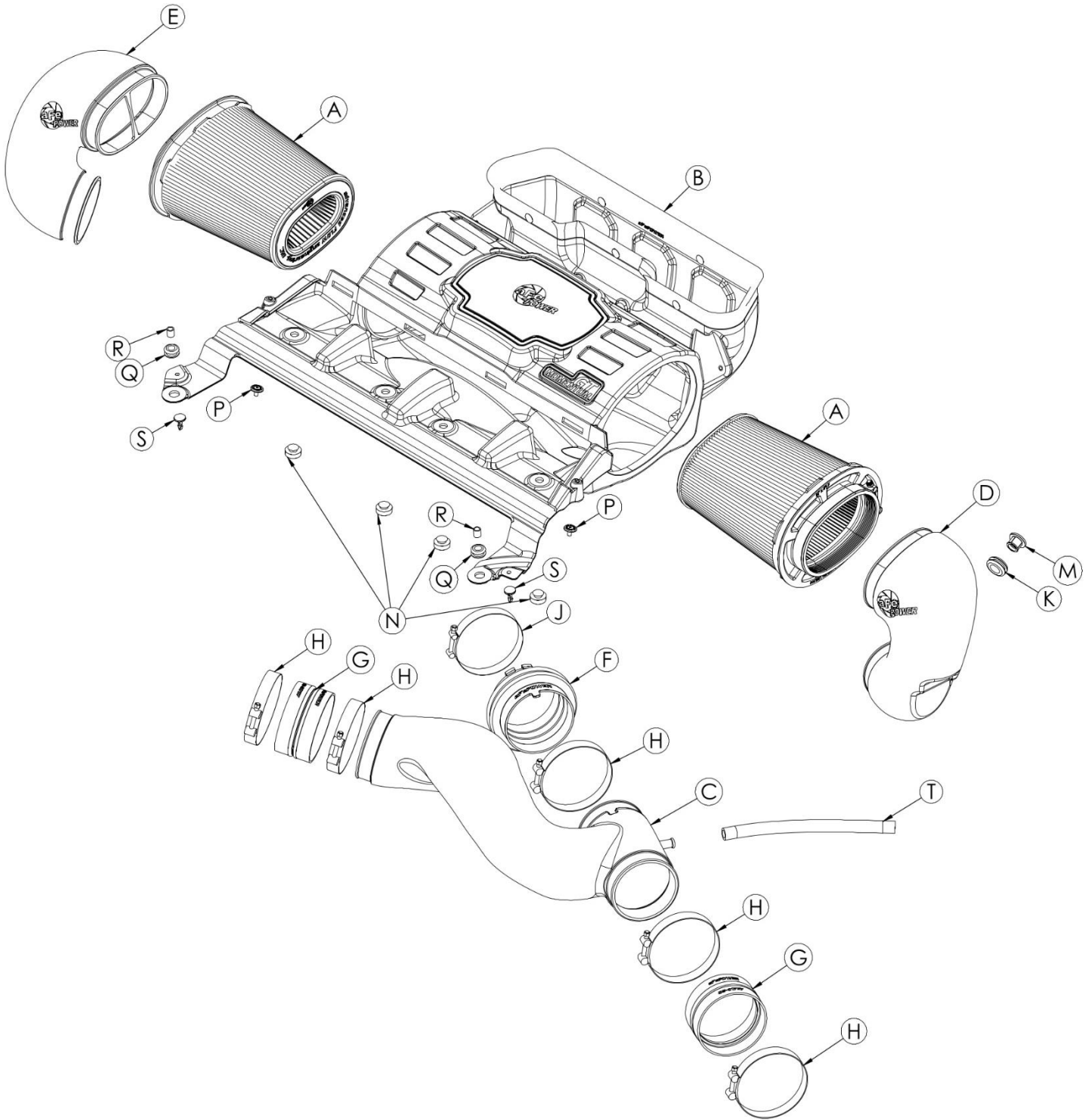



Refer to Figure A for Step 1

Step 1: Remove your engine cover ①.

**Figure B****Refer to Figure B for Step 2**

Step 2: Using a small trim removal tool, remove the sixteen (16) clips ② securing the factory front cowl, then remove the cowl.

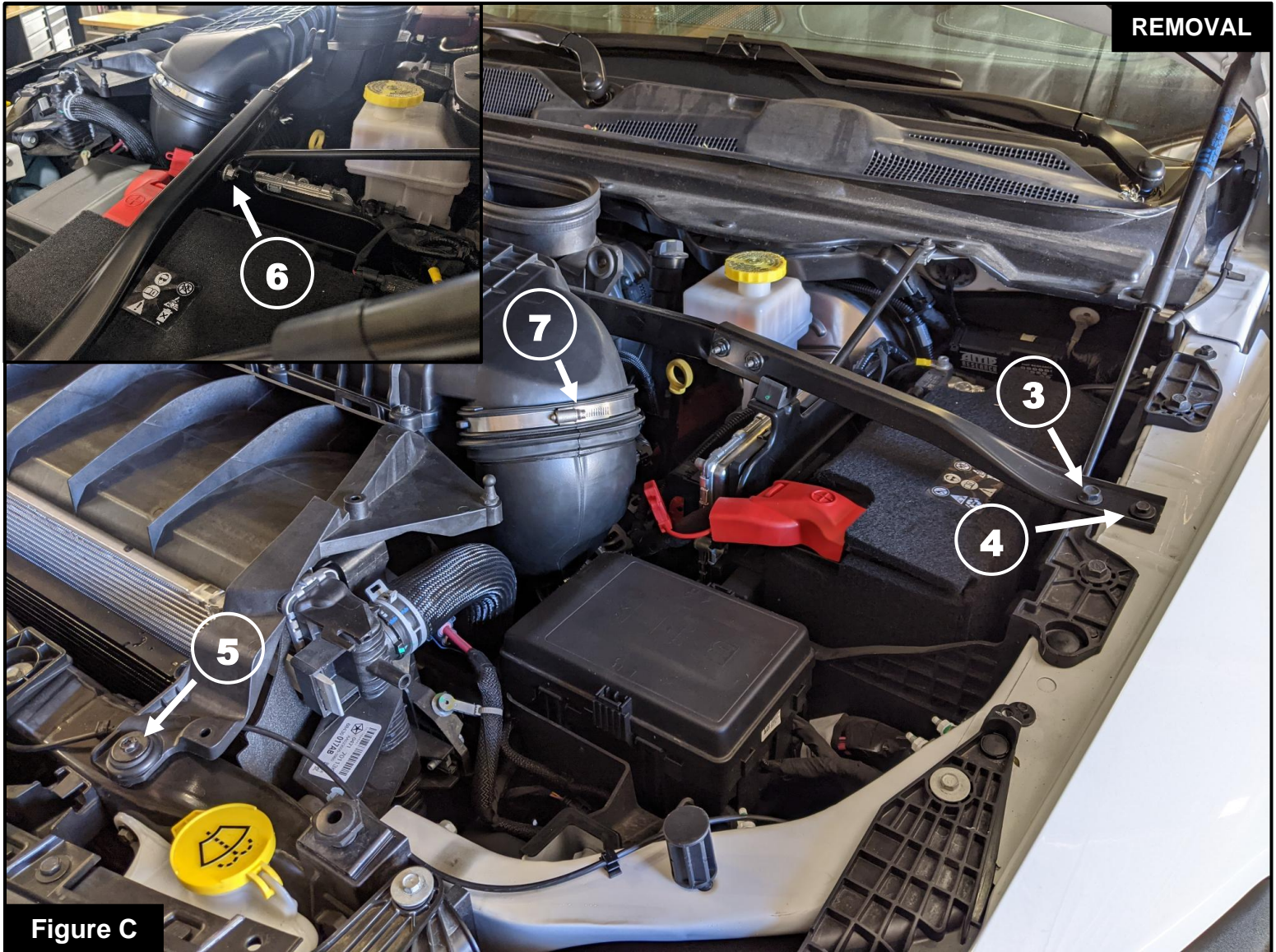

Figure C

Refer to Figure C for Steps 3-5

Step 3: On the driver side of the vehicle, use a 13mm socket and driver to remove the larger screw (3) securing the factory intake brace.

Step 4: Using a 10mm socket and driver, remove the smaller screw securing the factory intake brace (4) as well as the screw (5) securing the factory intake to the core support in the front of the vehicle. Remove the single nut (6) on the back side of the intake brace using a 10mm socket and driver.

Step 5: Using an 8mm socket and driver, loosen the clamp (7) at the factory air intake tube.

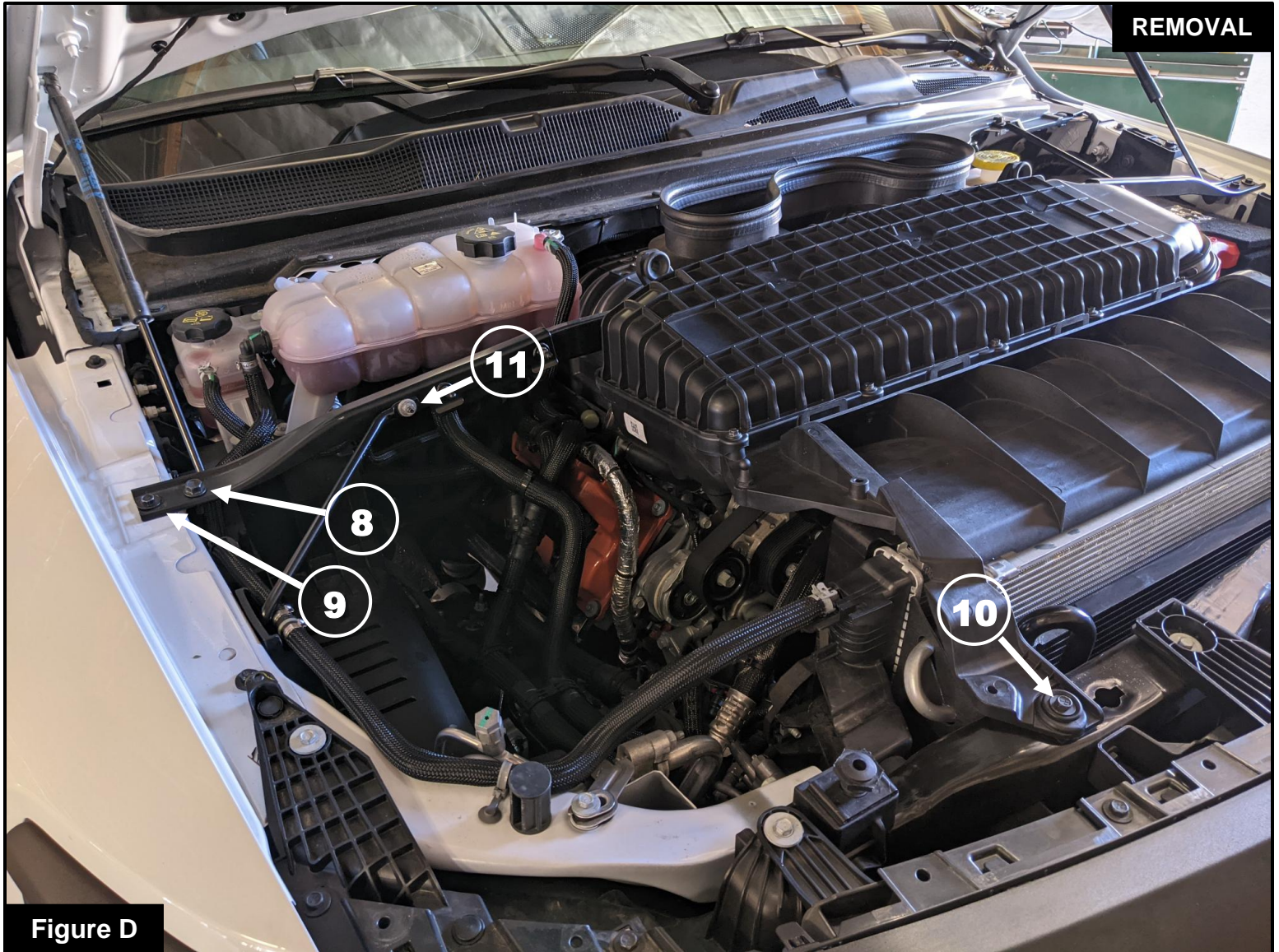

Figure D

Refer to Figure D for Steps 6-8

Step 6: On the passenger side of the vehicle, use a 13mm socket and driver to remove the larger screw (8) securing the factory intake brace.

Step 7: Using a 10mm socket and driver, remove the smaller screw securing the factory intake brace (9) as well as the screw (10) securing the factory intake to the core support in the front of the vehicle. Remove the single nut (11) on the front side of the intake brace using a 10mm socket and driver.

Step 8: Carefully lift the factory air intake out of the vehicle leaving the intake tube in the vehicle.

**Figure E****Refer to Figure E for Step 9**

Step 9: Transfer the rubber drain (12) from the factory airbox to the hole on the bottom of your aFe POWER filter housing. Orient the drain as shown.

**Figure F****Refer to Figure F for Step 10**

Step 10: Using an 8mm socket and driver with an extension, loosen the ten (10) screws ⑬ sealing the factory airbox and remove the lid.

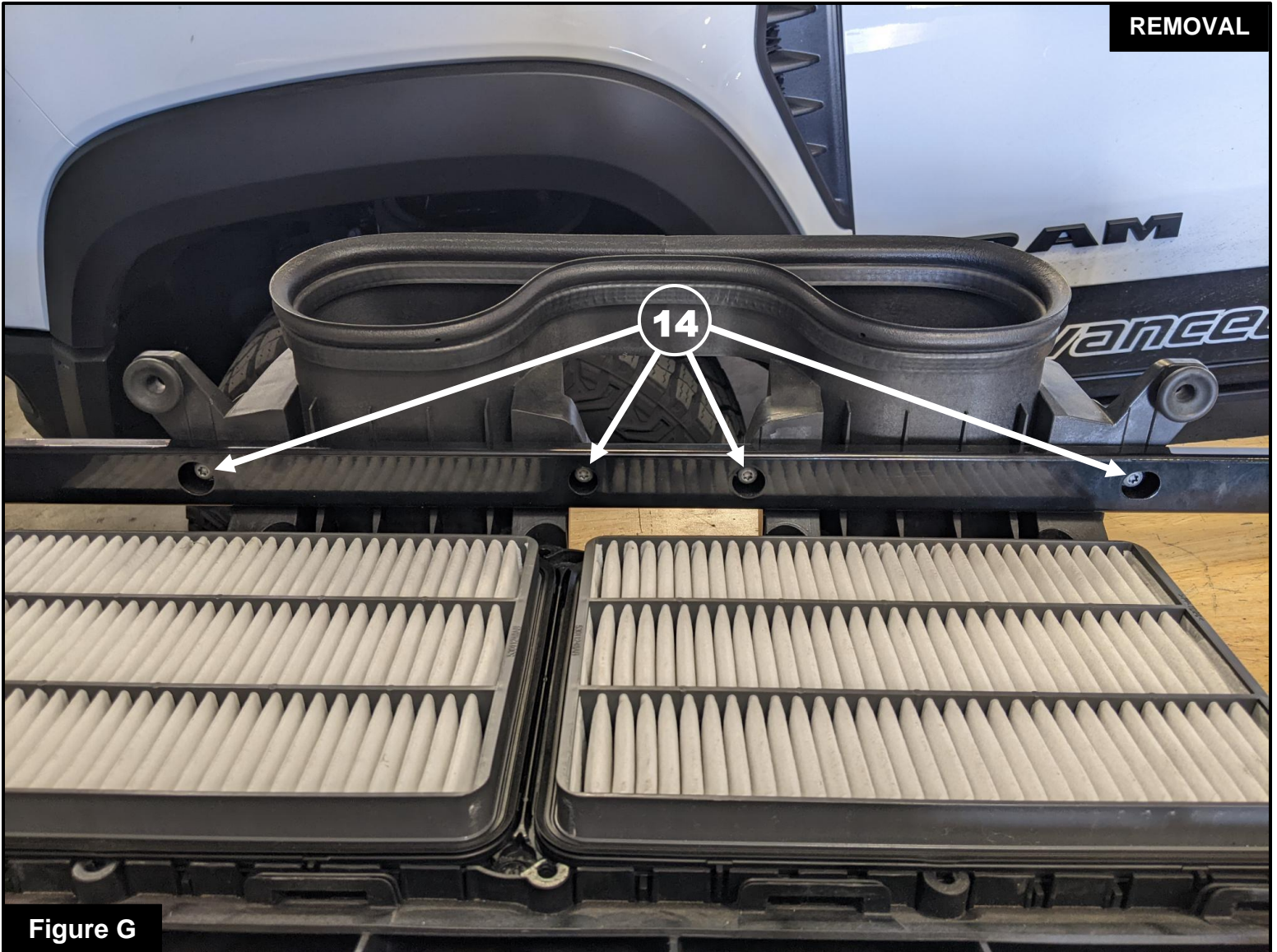
**Figure G****Refer to Figure G for Step 11**

Step 11: Using a T30 Torx driver, remove the four (4) screws (14) securing the intake brace to the factory airbox and remove the brace.

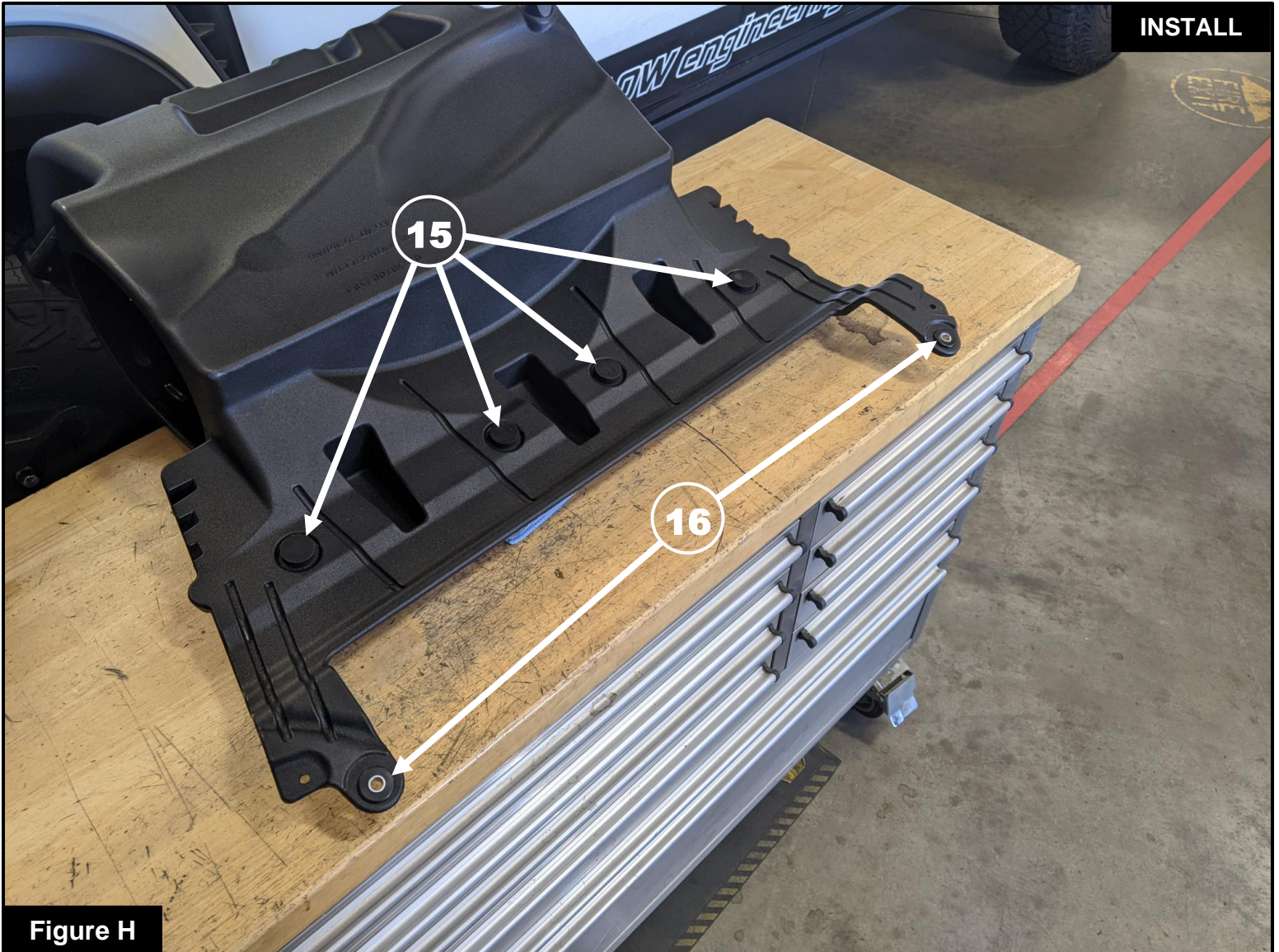
**Figure H****Refer to Figure H for Steps 12-13**

Step 12: Install the four (4) supplied rubber bumpers (15) into the ½” holes on your aFe POWER filter housing with the large padded side towards the bottom.

Step 13: Install the supplied 5/8” rubber grommets (16) into the holes on the very front of your aFe POWER filter housing. Press the supplied aluminum spacers into the grommets after they are installed.

**Figure J****Refer to Figure J for Step 14**

Step 14: Install the factory intake brace to your aFe POWER filter housing using two (2) of the T30 Torx screws removed in step #11. Do not overtighten the screws.

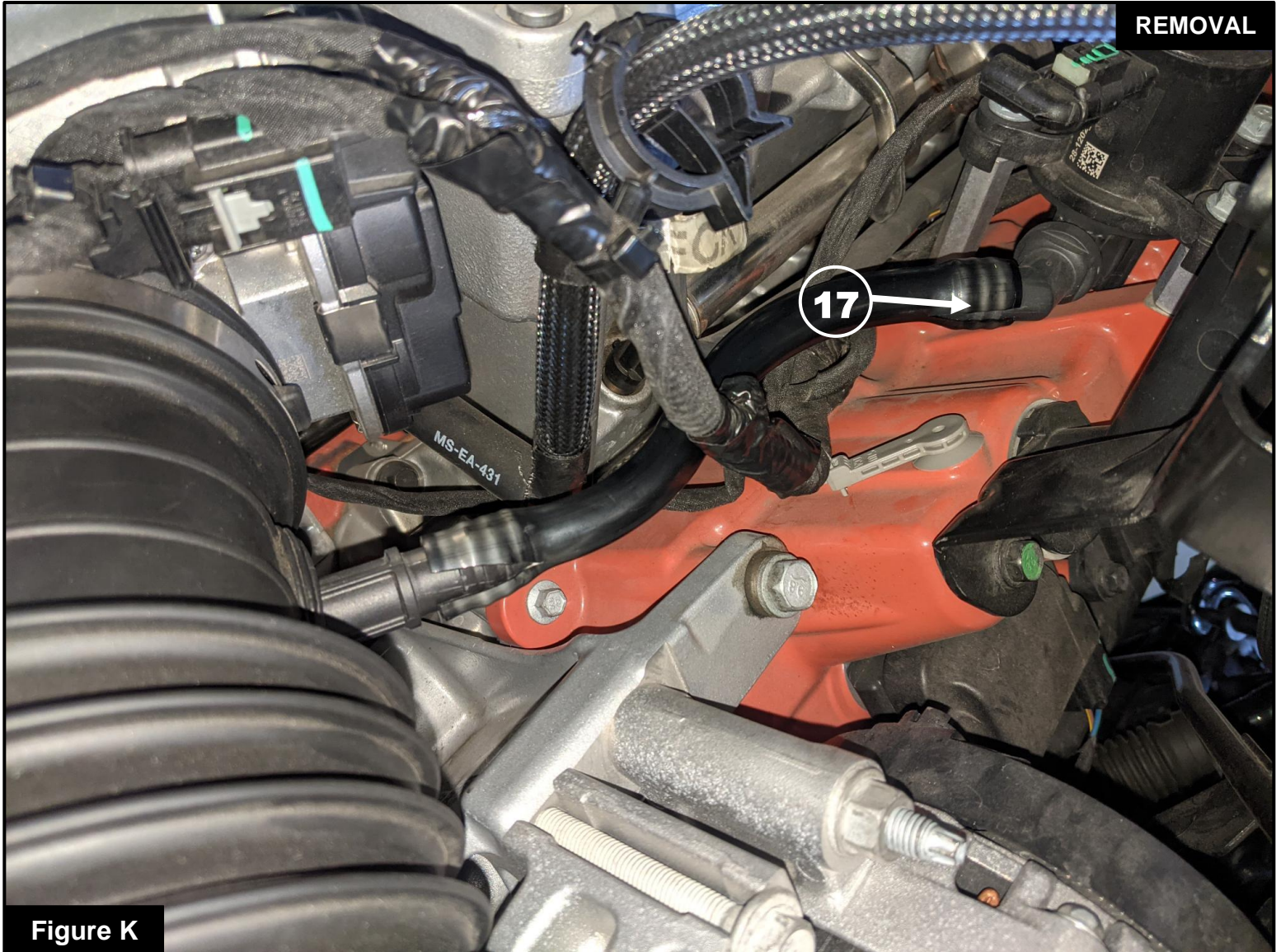

Figure K

Refer to Figure K for Step 15

Step 15: Using a razor blade, carefully cut the plastic line ①7 connected to the MUA system on the valve cover. If you ever need to reinstall the factory intake, we recommend using heat-shrink to cover the cut.

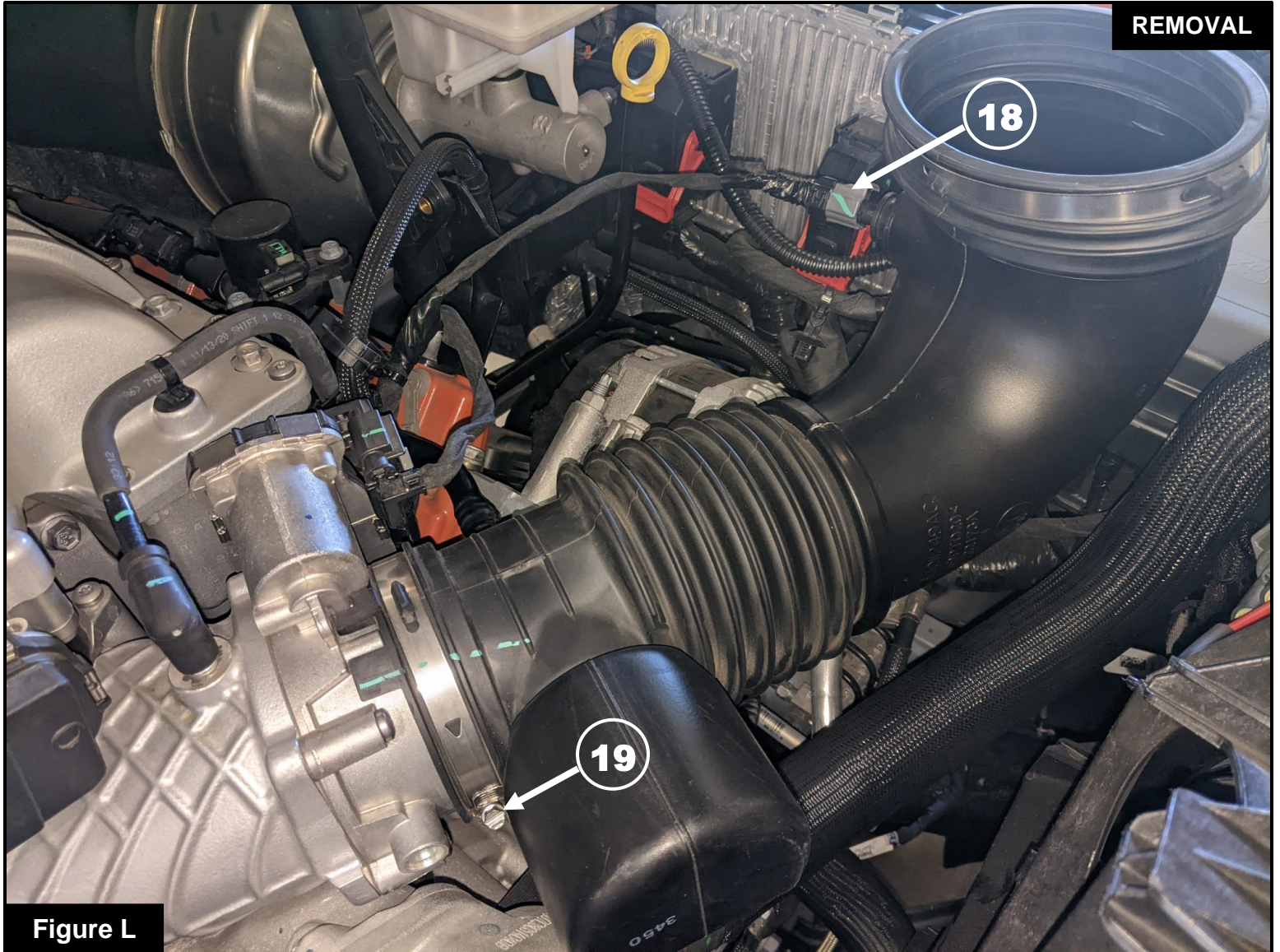

Figure L

Refer to Figure L for Steps 16-17

Step 16: Disconnect the temperature sensor wire harness (18) .

Step 17: Using an 8mm socket and driver, loosen the clamp at the throttle body (19) then remove the factory air intake tube.

**Figure M****Refer to Figure M for Step 18**

Step 18: Install the supplied 1" rubber grommet and temperature sensor fitting (20) into the driver side air intake tube. The arrow on the fitting should point in the direction of the airflow in the tube.



Figure N

Refer to Figure N for Step 19

Step 19: Transfer the temperature sensor from the factory air intake tube to your aFe POWER air intake tube.

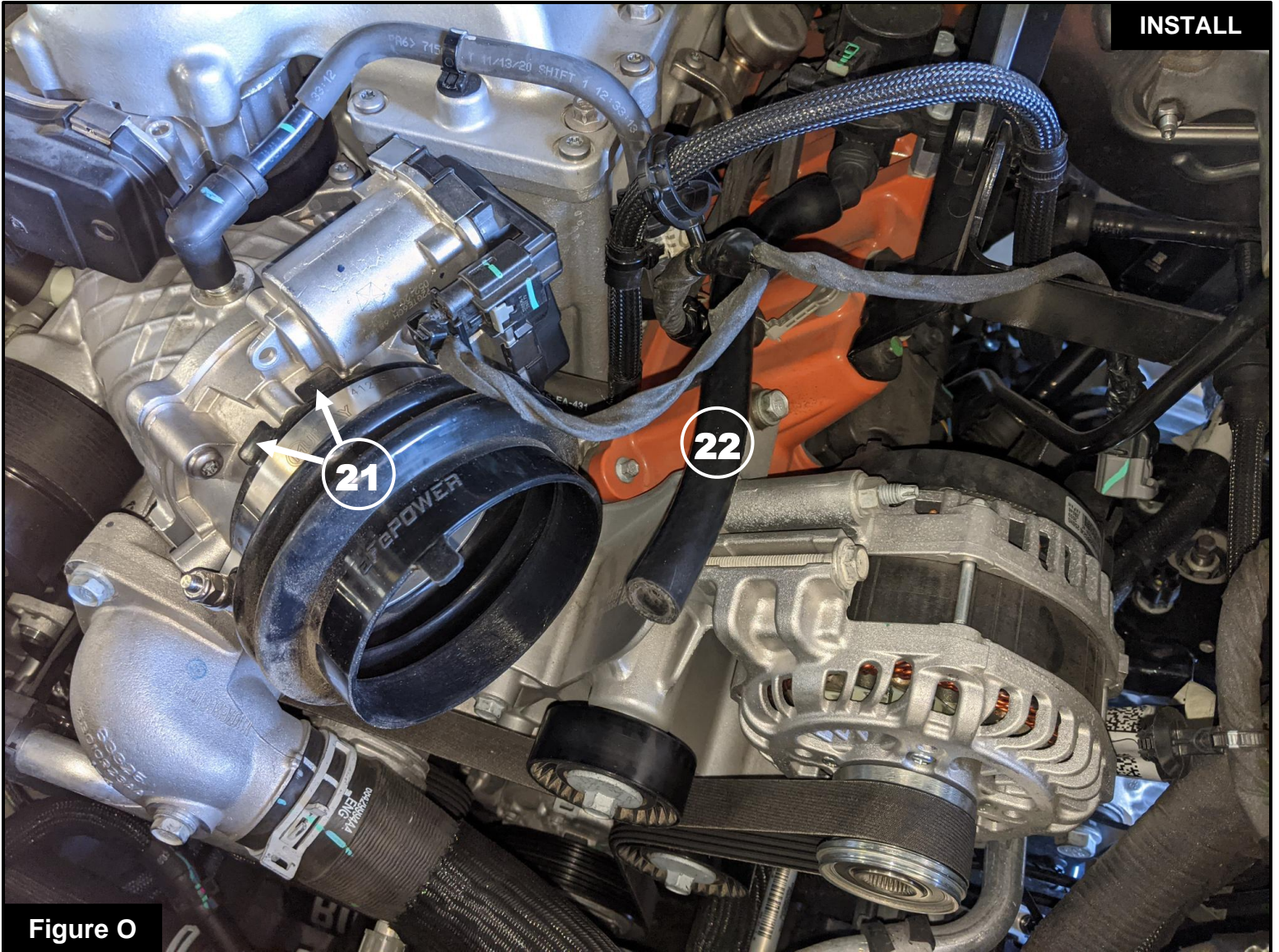
**Figure O****Refer to Figure O for Steps 20-21**

Step 20: Install the supplied bellow coupling with the smaller side on the throttle body making sure the indexing tabs (21) are straddling the index on the top of the throttle body as shown. Once aligned, secure the coupling with the smallest supplied T-Bolt clamp and tighten using an 11mm deep socket and driver.

Step 21: Install the supplied length of hose (22) onto the MUA system as shown.



Figure P

Refer to Figure P for Step 22

Step 22: Install the supplied straight couplings with T-Bolt clamps ②③ onto opposite ends of the larger aFe POWER intake tube as shown. Tighten the clamps using an 11mm deep socket and driver.

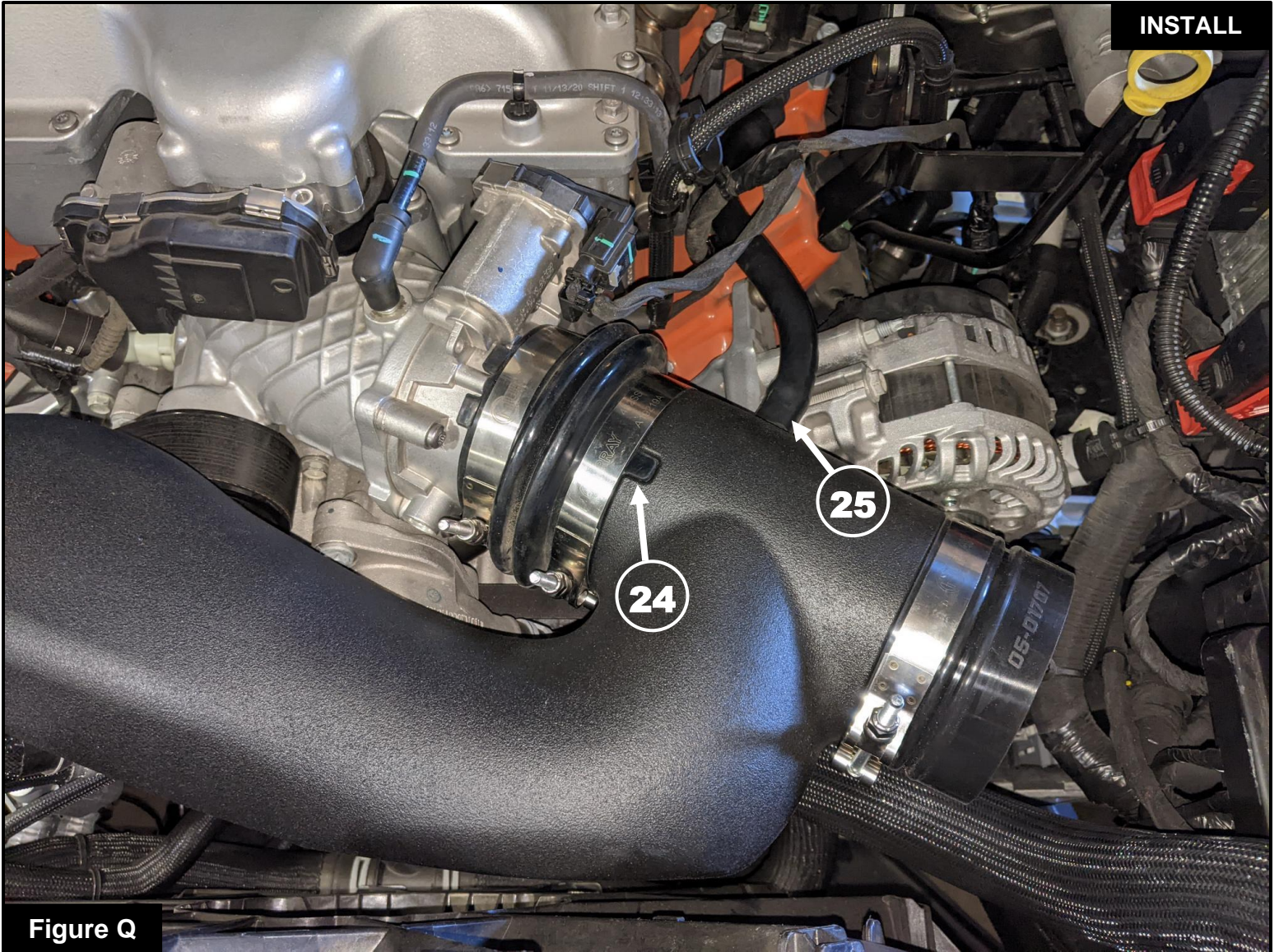
**Figure Q****Refer to Figure Q for Steps 23-24**

Step 23: Install the larger intake tube assembly into the coupler at the throttle body with one of the remaining T-Bolt clamps, lining up the index on the coupler (24) with the index on the tube. Tighten using an 11mm socket and ratchet.

Step 24: Connect the open end of the previously installed hose (25) to the port on the intake tube.

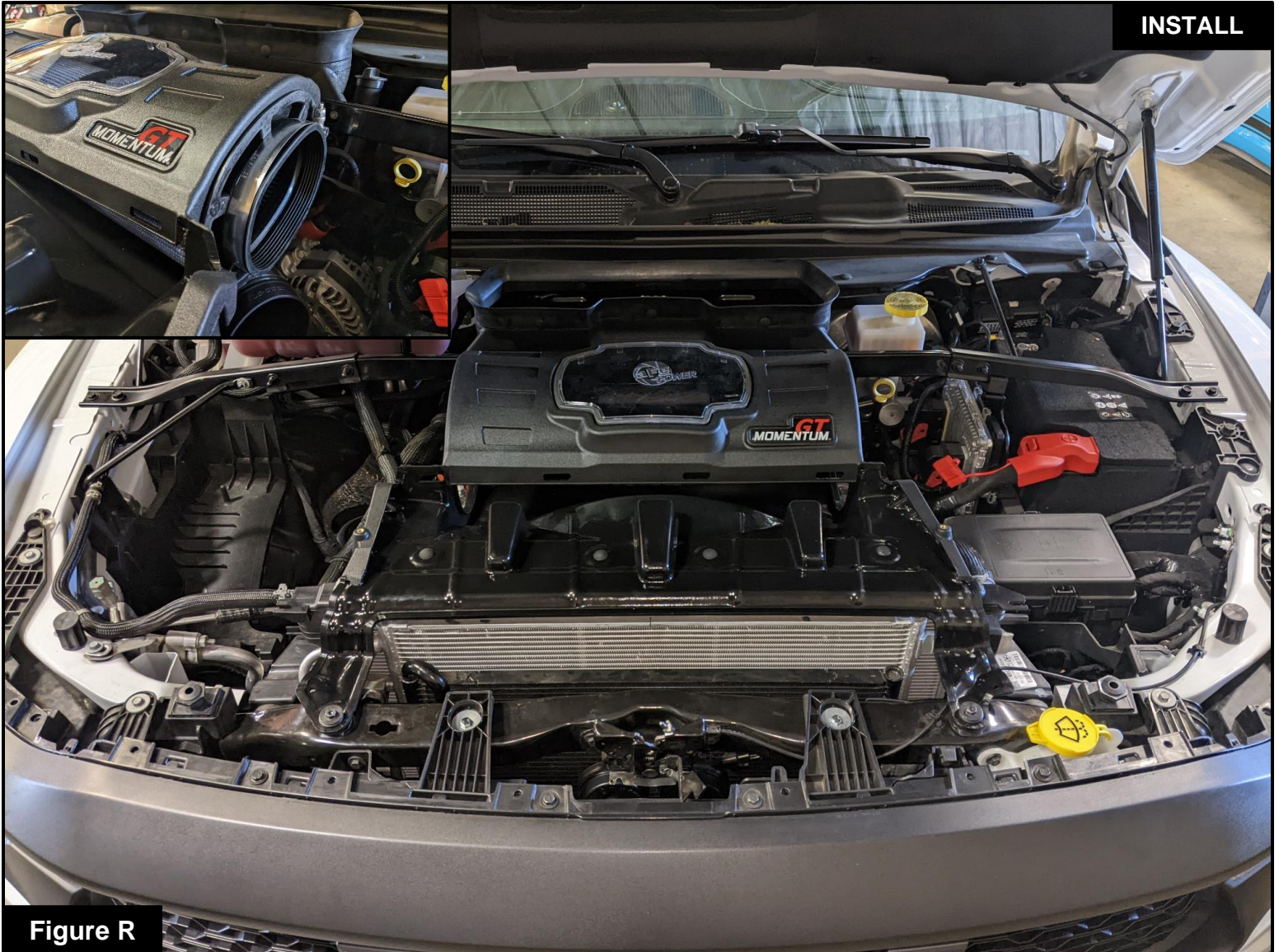

Refer to Figure R for Steps 25-26

Step 25: Install your aFe POWER housing assembly back into the vehicle by following steps 3-7 in reverse order.

Step 26: Install your aFe POWER air filters into the filter housing by pressing them into the opening on either side of the housing until they lock into place as shown.

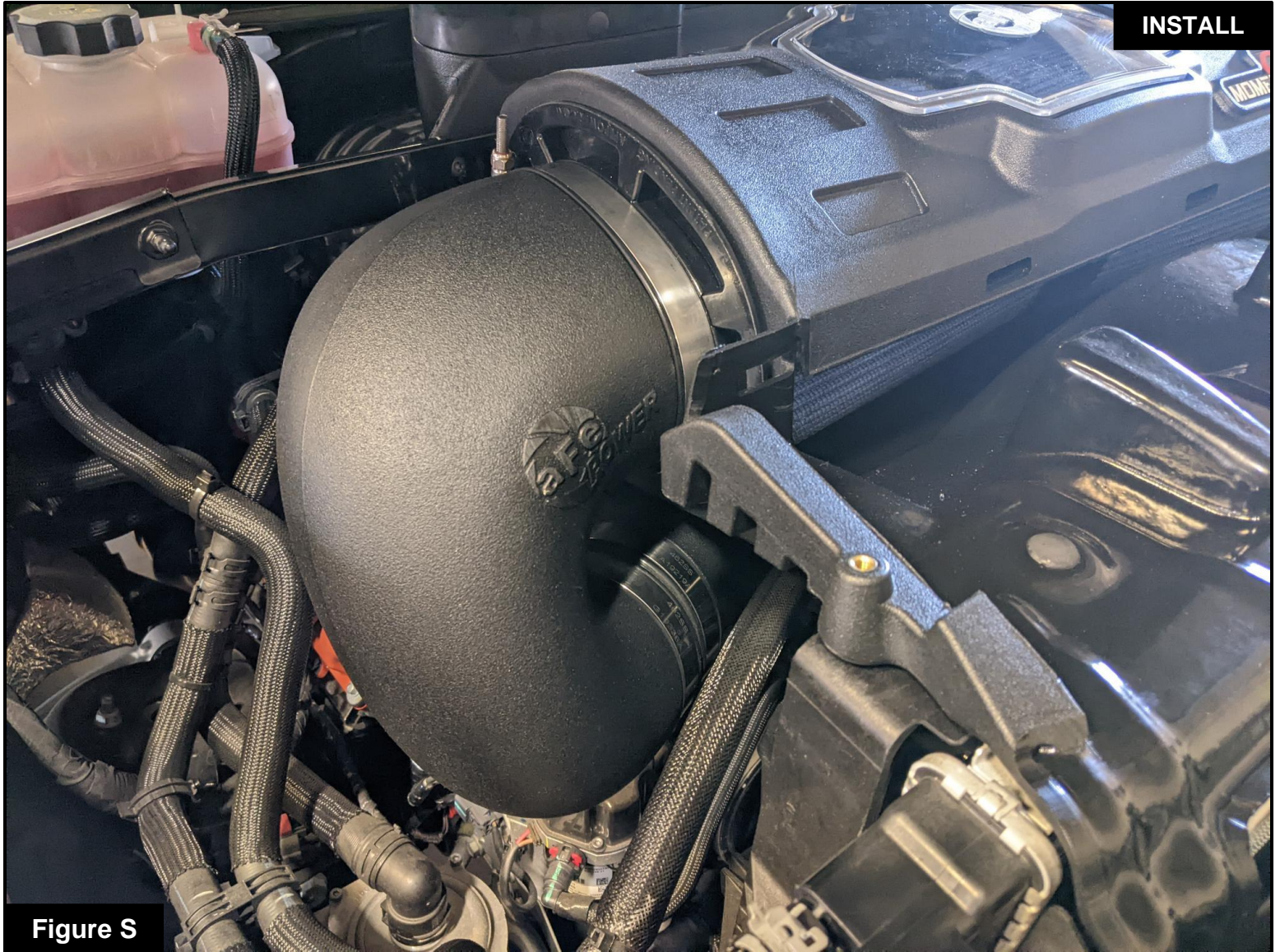
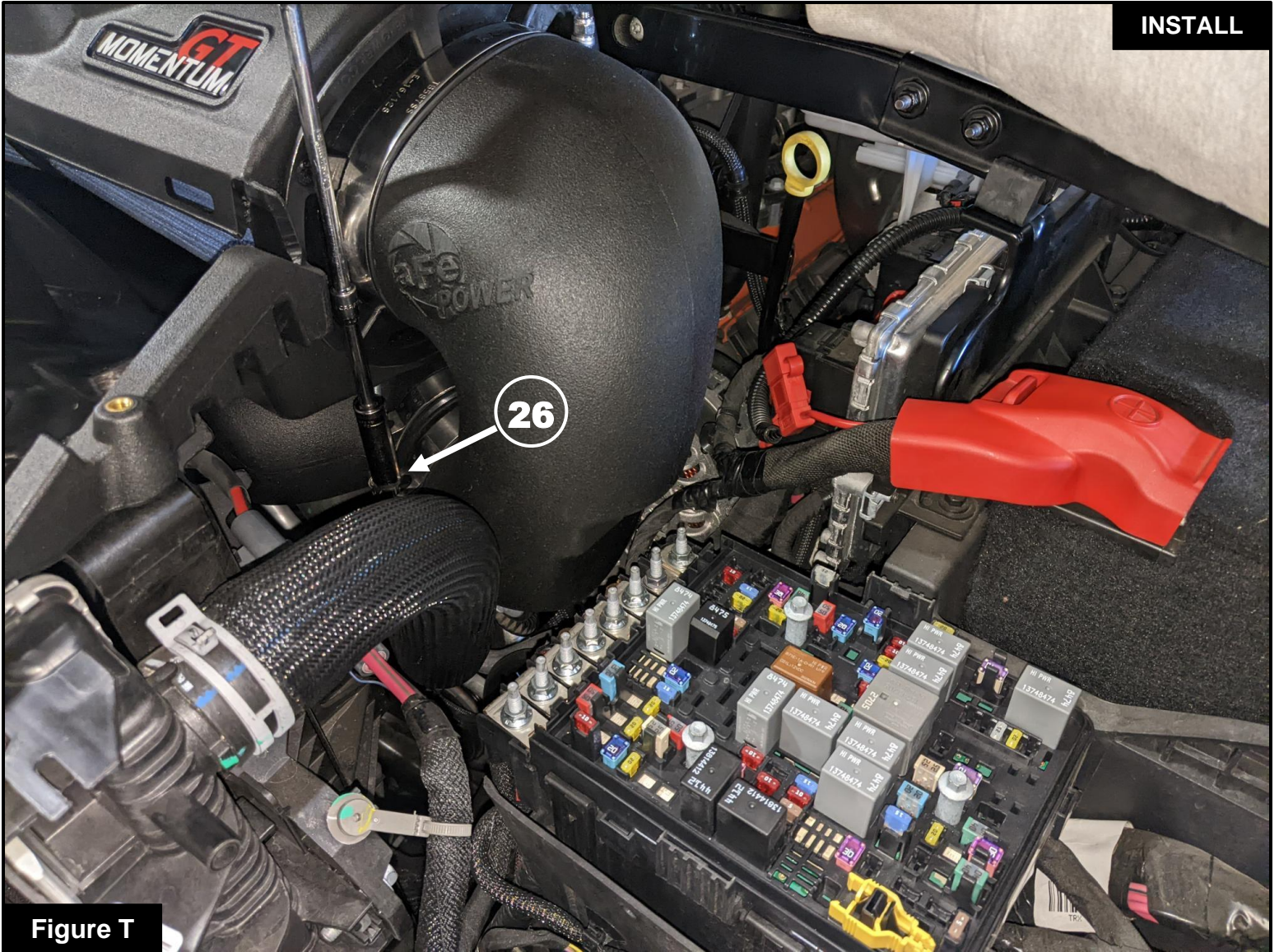

Figure S

Refer to Figure S for Step 27

Step 27: Install the passenger side intake tube with one of the remaining T-Bolt clamps into the coupler below the housing, then into the air filter opening. Tighten both clamps using an 11mm deep socket and driver.

Figure T

Refer to Figure T for Steps 28-30

Step 28: Remove the fuse box cover for additional clearance.

Step 29: Install the driver side intake tube with the final T-Bolt clamp into the coupler below the filter housing.

The screw on the T-Bolt clamp (26) needs to be towards the front of the vehicle as shown, otherwise it will interfere with the alternator pulley. Tighten the clamp using an 11mm deep socket and 12" extension as shown.

Step 30: Reinstall the fuse box cover once the tube is installed.

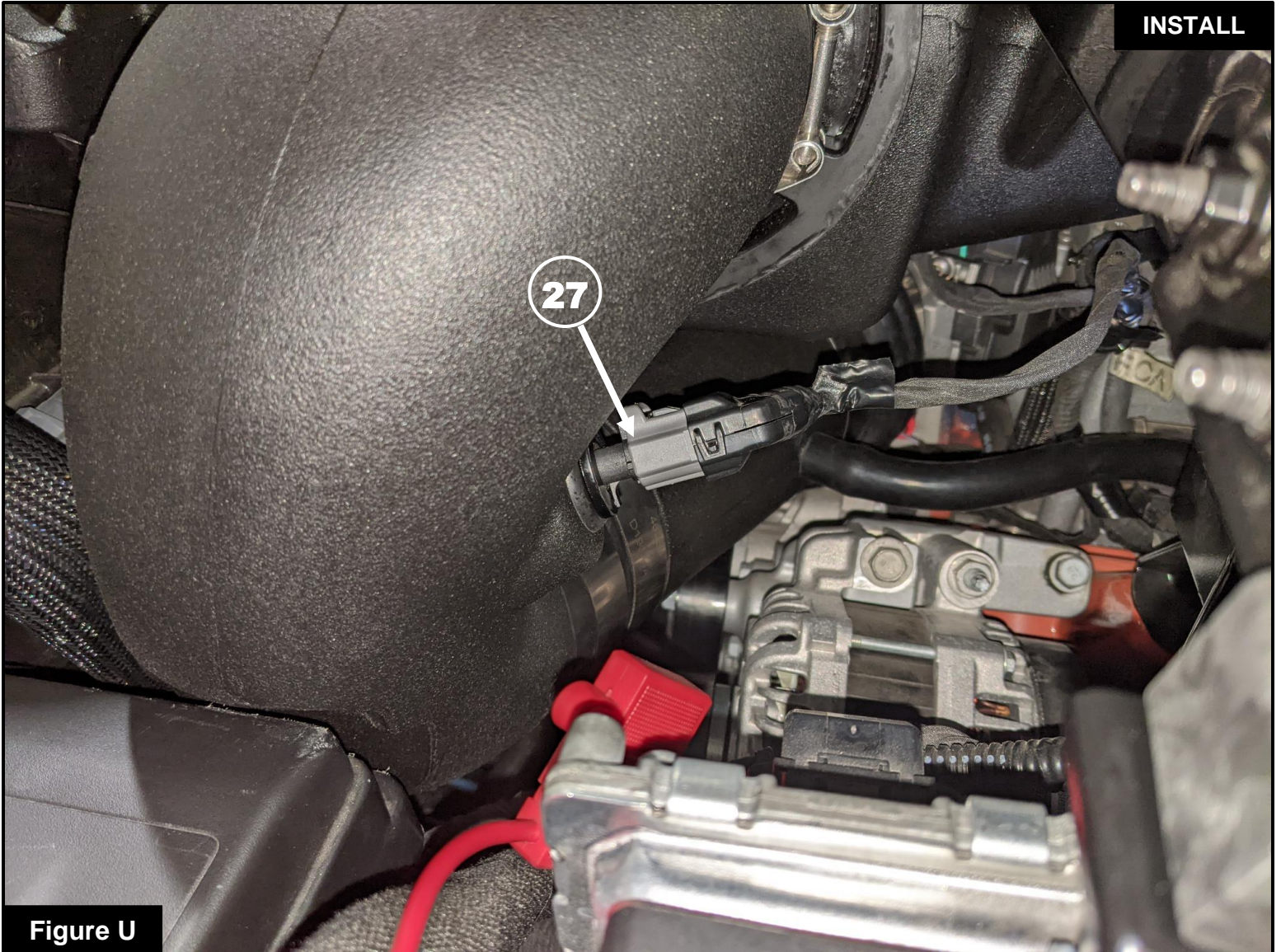

Figure U

Refer to Figure U for Step 31

Step 31: Reconnect the temperature sensor wire harness (27) to the sensor on the back side of the driver side intake tube.



Figure V

Refer to Figure V for Step 32

Step 32: Using a 1/2" drill bit, open up the top two holes (28) on the factory cowl.



Figure W

Refer to Figure W for Step 33

Step 33: Reinstall the cowl on the front of the truck. Before installing the plastic clips, secure the cowl using the two (2) supplied screws & washers (29) in the top holes. Use a 3mm allen key to tighten the screws.

**Figure X****Refer to Figure X for Steps 34-35**

- Step 34: Install the supplied 22mm push clips (the longer clips) in the two locations (30) shown above.
- Step 35: Using the rest of the clips removed in step 2, secure the cowl to the front of the vehicle. There should be 4 factory clips remaining when the installation is complete. Your installation is now complete.
- Thank you for choosing aFe POWER!

NOTE: Check all screws, clamps, and connectors are secure after 100-200 miles.



THIS PAGE LEFT BLANK INTENTIONALLY

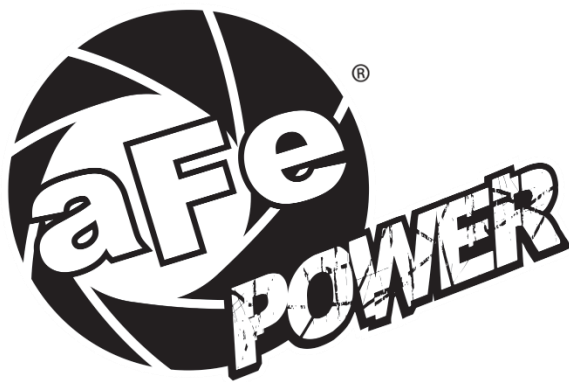

advanced FLOW engineering, inc.

252 Granite Street Corona, CA 92879
TEL: 951.493.7100 • TECH: 951.493.7185
E-Mail: Tech@aFepower.com