

# MOMENTUM **HD**

**advanced FLOW engineering** Momentum HD Stage-2 Cold Air Intake System

**Instruction Manual** P/N: 50-70062D / 50-70062T / 50-70062G

Make: Jeep

Model: Wrangler (JL/JLU)

Year: 2020-2023

Engine: V6-3.0L (td)

Make: Jeep

Model: Gladiator (JT)

Year: 2021-2023

Engine: V6-3.0L (td)



- Please read the entire instruction manual before proceeding.
- Ensure all components listed are present.
- If you are missing any of the components, call customer support at 951-493-7185.
- Ensure you have all necessary tools before proceeding.
- Do not attempt to work on your vehicle when the engine is hot.
- Retain factory parts for future use.

Label	Qty.	Description	Part Number
A1	1	Air Filter (Pro DRY S)	21-91153
A2	1	Air Filter (Pro 10R)	20-91153
A2	1	Air Filter (Pro GUARD 7)	72-91153
B	1	Tube	05-5070062B1
C	1	Housing	05-5070062B2
D	1	Inlet, Silicone Seal	05-01592
E	1	Coupling, Silicone Elbow: (3.5"x3")ID x 58Deg	05-01591
F	1	Crank Case Vent (CCV) Insert	05-01590
G	1	Rubber Mounting Grommet	03-50534
H	1	Clamp, T-bolt (3-9/16"-3-7/8") (SS)	03-50498
I	1	Clamp, T-bolt (3-1/16"- 3-3/8") (SS)	03-50320
J	1	Clamp, Mini 012 (11/16" - 1-1/4")	03-50023
K	2	Screws, Torx: M4x0.7 x 8mm Long	03-50491
L	3	Retainer Clip, 1/4" Hole	05-01350
M	1	T20 Torx bit	03-50066

**Installation will require the following tools:**

8mm nut driver, 10mm socket and wrench, 11mm deep socket or hollow shaft nut driver, T20 Torx bit (included) and driver, Needle-nose pliers, and Flat-head screwdriver.

Warranty Information available at: <https://afepower.com/contact#warranty>

**Emissions Disclaimer:** This product is not currently CARB exempt and is not available for purchase in California or for use on any vehicle registered with the California Department of Motor Vehicles.

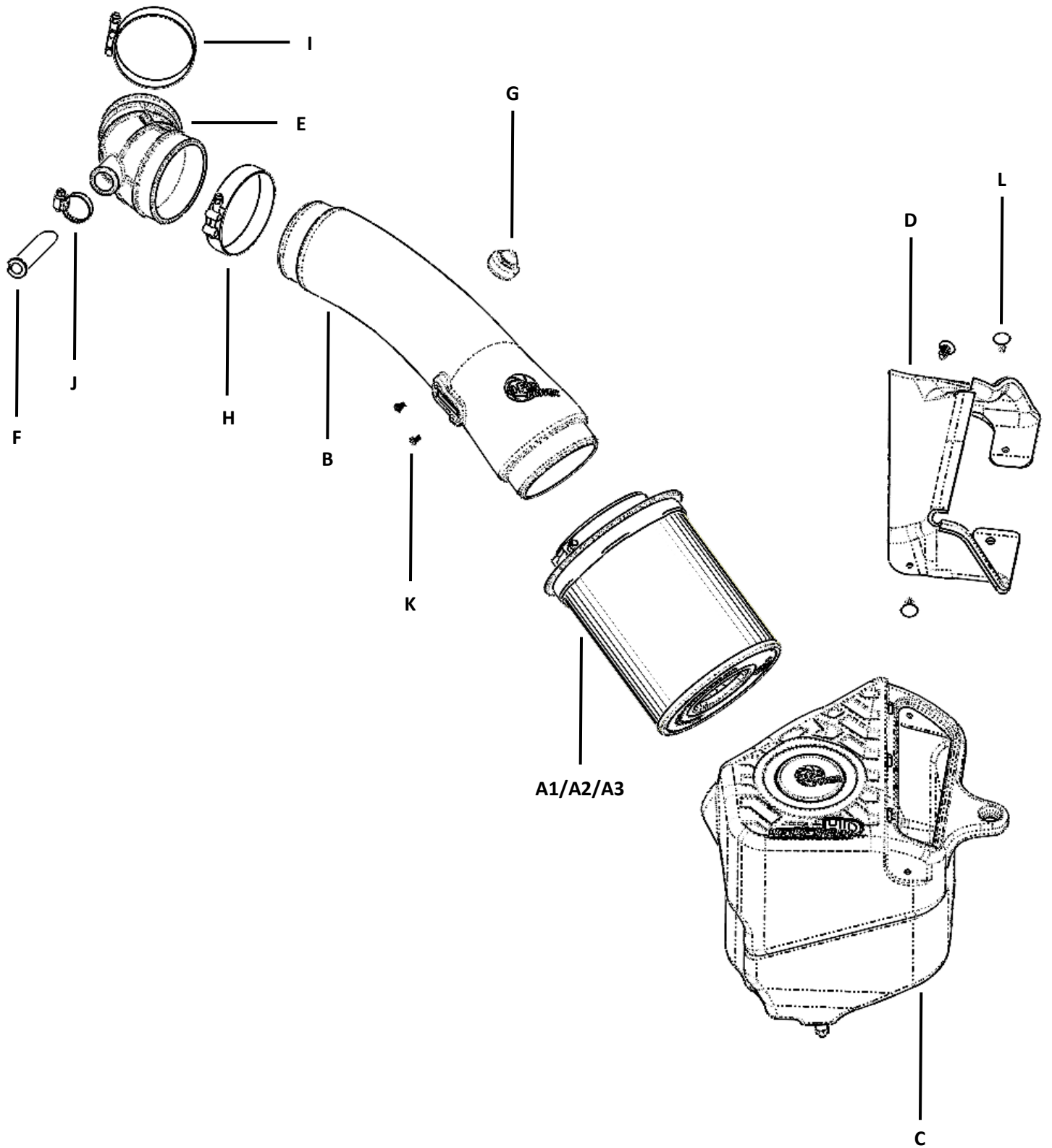

**Figure A****Refer to Figure A for Steps 1-2**

**Step 1:** Using a 10mm socket and driver, remove the (2) two screws from the engine cover (1).

**Step 2:** Remove the engine cover from the vehicle by lifting upward to clear the oil fill cap and then pull it forward (2).



REMOVAL

Figure B

**Refer to Figure B for Steps 3-8**

- Step 3:** Disconnect the CCV hose from the engine side (3).
- Step 4:** Disconnect the MAF sensor harness from the MAF sensor (4).
- Step 5:** Disconnect the Temp sensor harness from the Temp sensor on the CCV hose (5).
- Step 6:** Using an 8mm nut driver, loosen the clamp on the intake tube connected to the turbo inlet pipe (6).
- Step 7:** Unclip the intake tube at the housing by spreading the clip apart and pulling the tube off the housing (7).
- Step 8:** Twist the intake tube off of its mounting post and remove the intake tube from the vehicle.

**Figure C****Refer to Figure C for Steps 9-10**

**Step 9:** Carefully separate the pinch clamp (8) on the intake tube using a pair of needle nose pliers.

**Note:** do not loosen the second pinch clamp on the CCV hose side.

**Step 10:** With the clamp loosened, remove the CCV hose from the intake tube as shown.

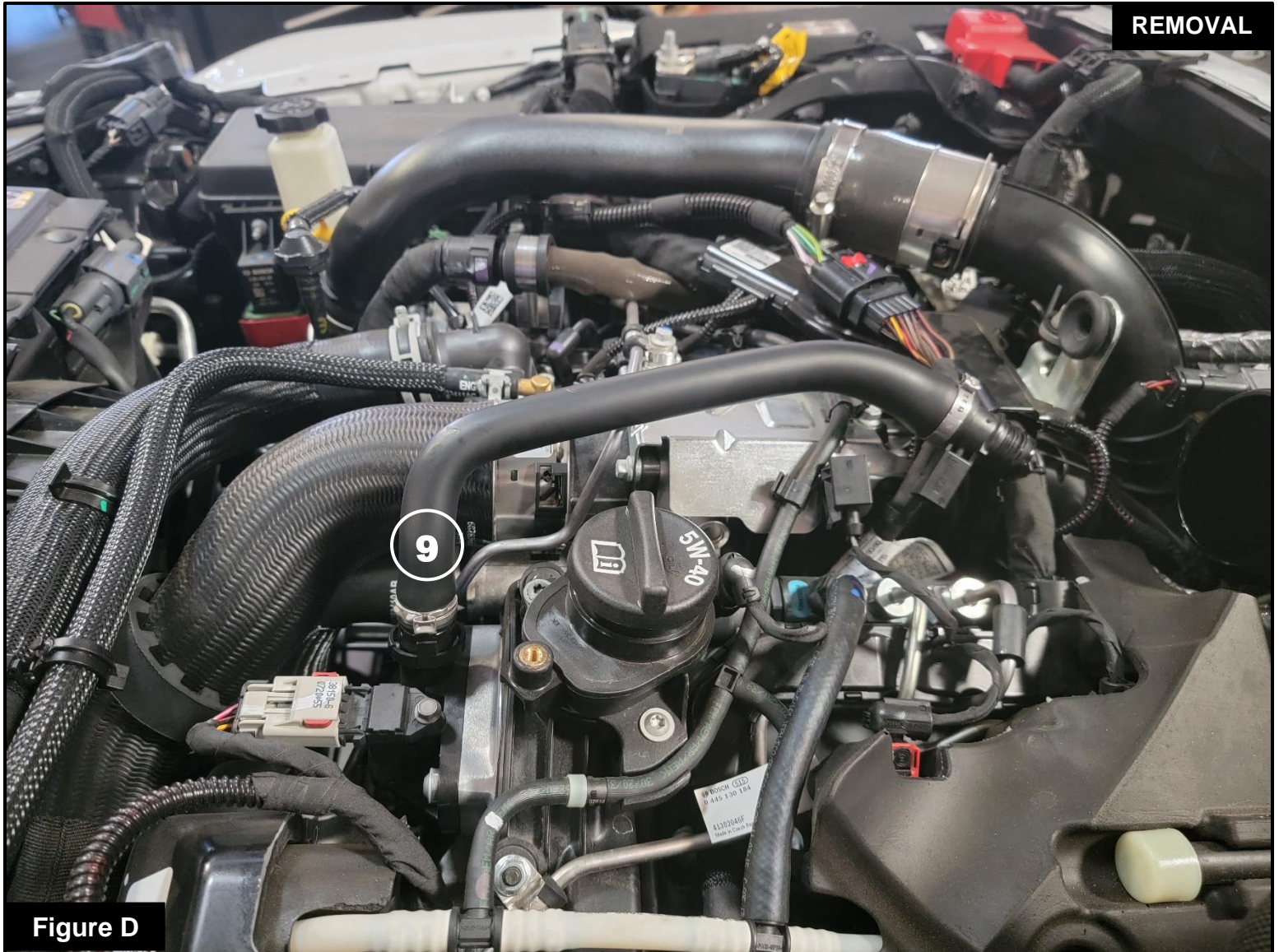
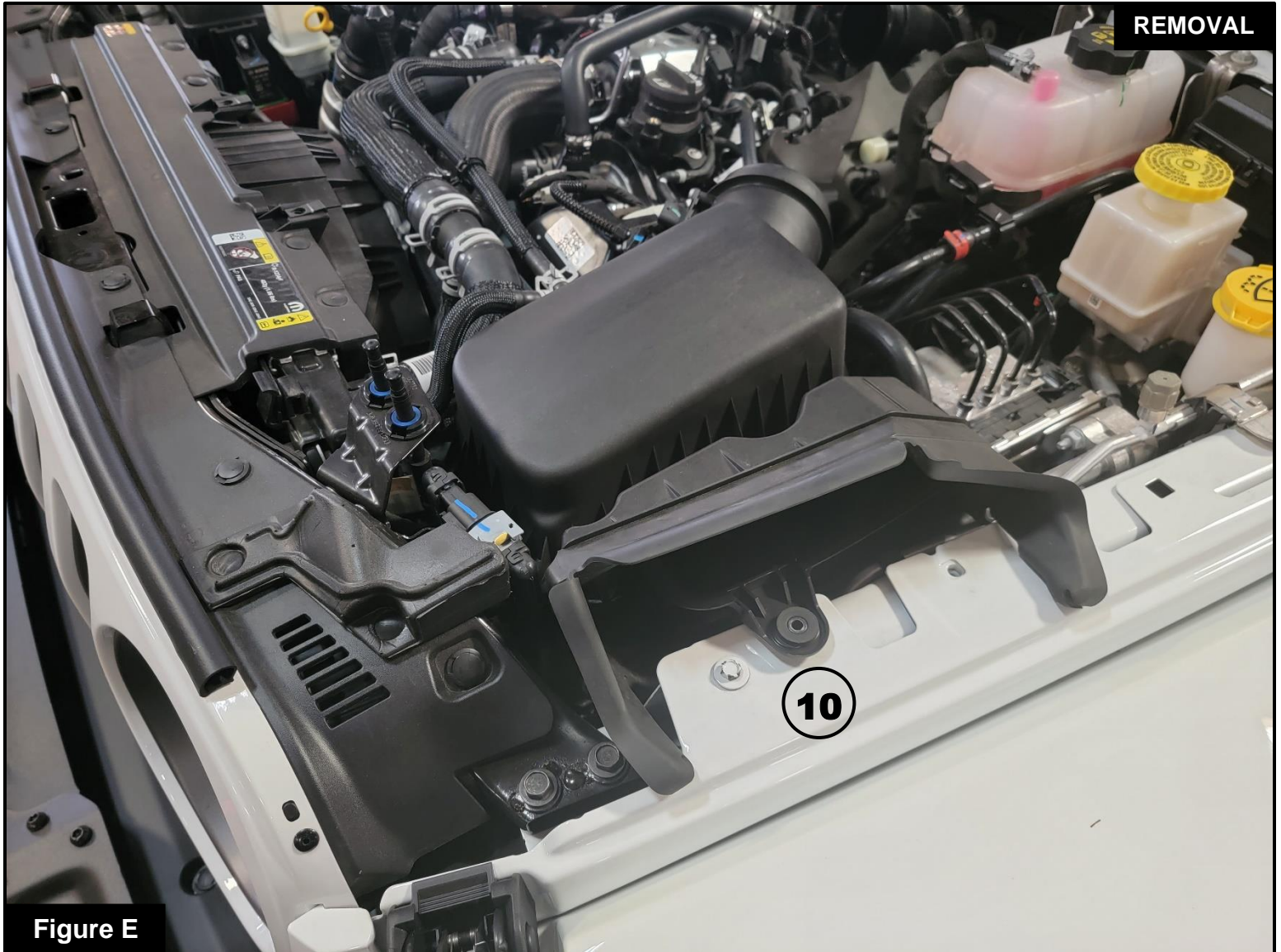

Figure D

**Refer to Figure D for Step 11**

**Step 11:** Reconnect the CCV hose to the engine side ⑨, but do not connect the Temp sensor harness at this time.



**Figure E**

**Refer to Figure E for Steps 12-13**

**Step 12:** Using a 10mm socket and driver, remove the screw securing the intake housing to the fender ⑩.

**Step 13:** Remove the intake housing from the vehicle by tilting it away from the fender and then lifting it straight upward.



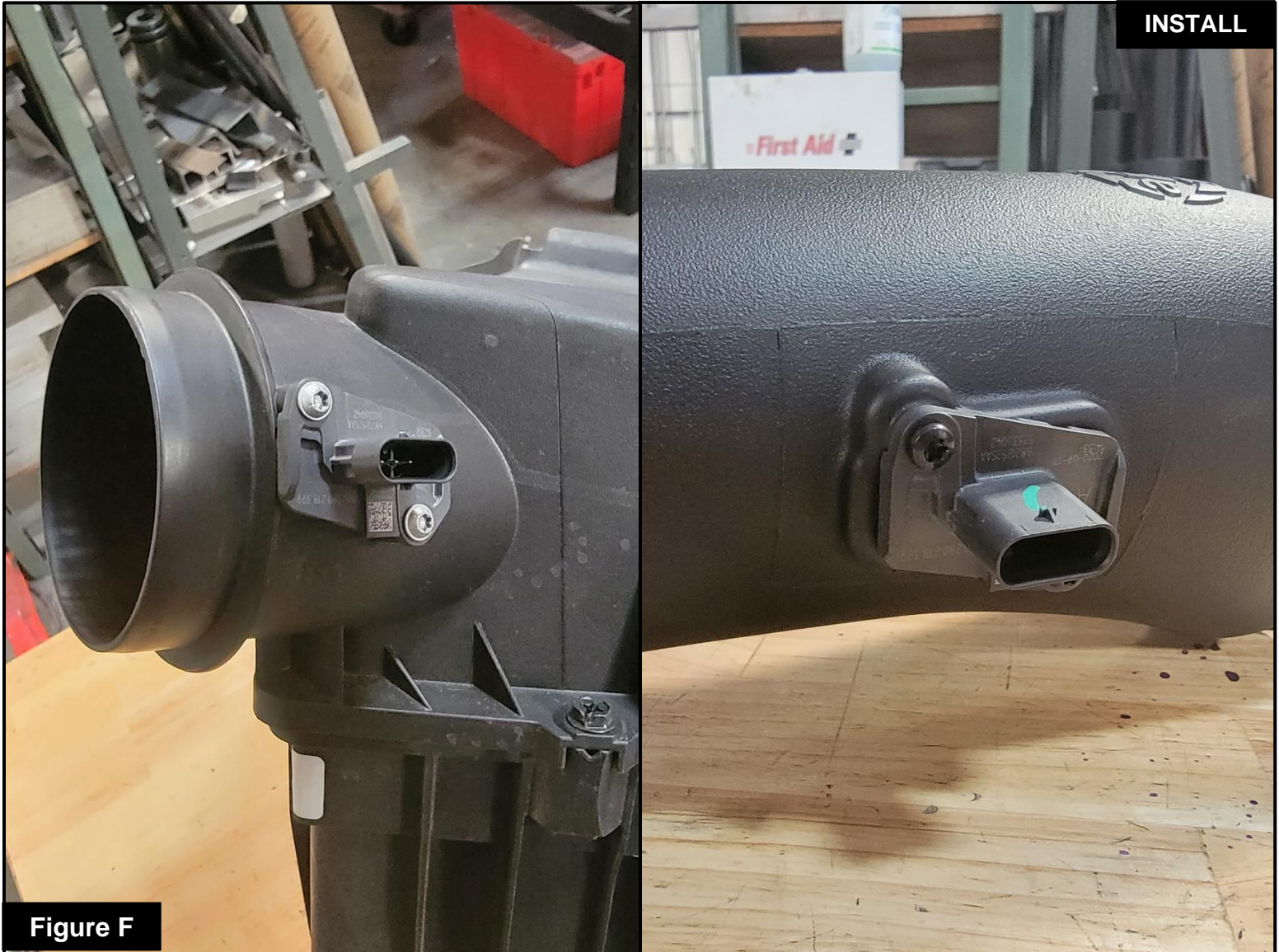

**Refer to Figure F for Steps 14-15**

**Step 14:** Using the provided T20 Torx bit, remove the MAF sensor from the OE housing.

**Step 15:** Using the (2) two provided M4 screws and T20 Torx bit, reinstall the MAF sensor in the same orientation into the new aFe intake tube as shown.



**Figure G**

**Refer to Figure G for Steps 16-18**

**Step 16:** Place the appropriate clamps loosely onto the ends of the coupling in the orientations shown.

**Step 17:** Install the coupling onto the end of the aFe intake tube as shown (11), but do not tighten any of the clamps at this time.

**Step 18:** Install the mounting grommet from the bottom of the mounting bracket as shown (12).

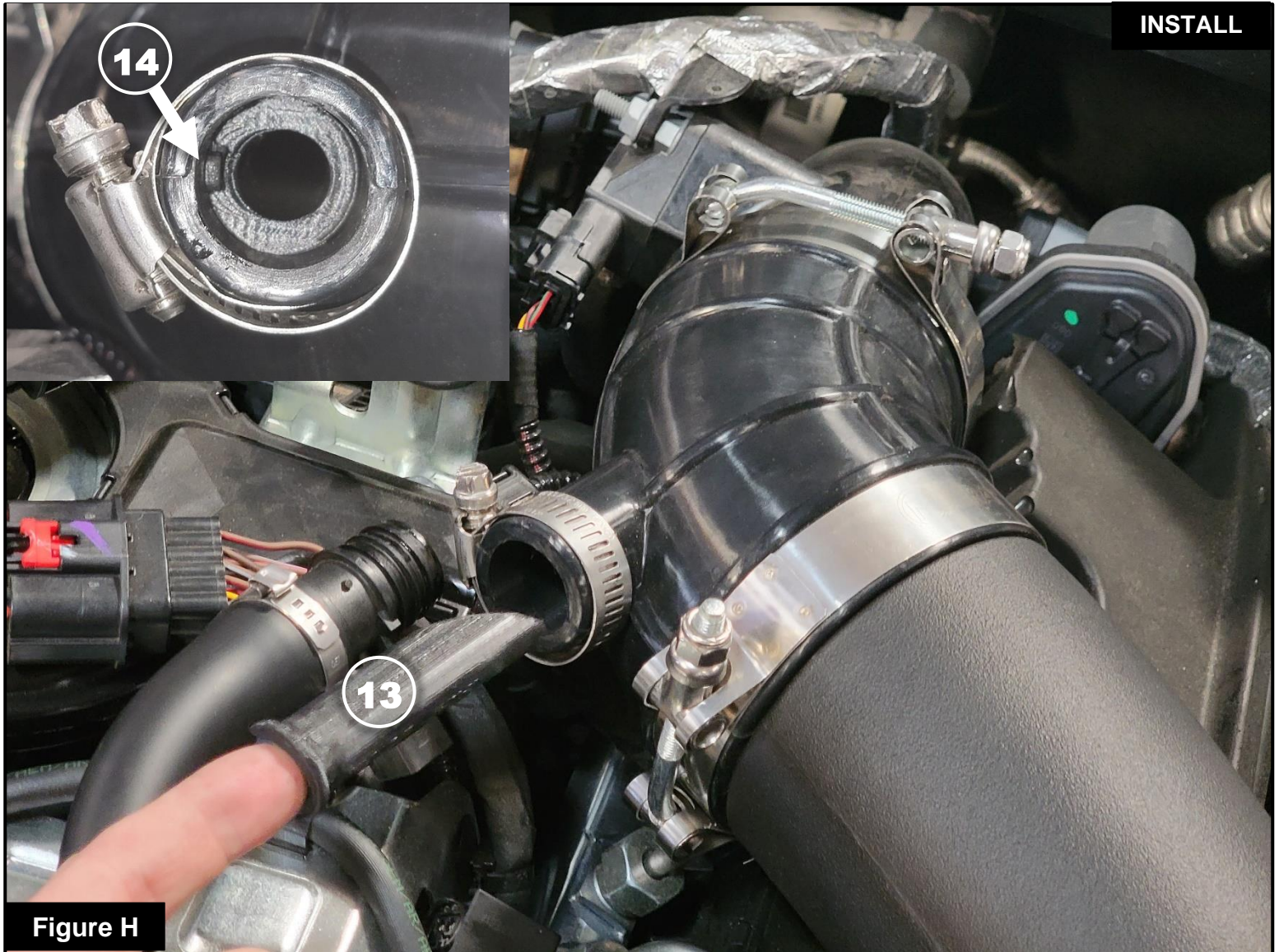

Figure H

**Refer to Figure H for Steps 19-20**

**Step 19:** Insert the CCV adaptor (13) into the small port on the coupling as shown. The slash cut face will point towards the turbo inlet pipe.

**Step 20:** Align the notch on the CCV Adaptor with the tab inside the coupling (14). Make sure the CCV adaptor is pressed all the way into the coupling.

**WARNING:** If these steps are not done correctly, a Check Engine Light (CEL) will occur!

**Figure I**

### **Refer to Figure I for Steps 21-22**

**Step 21:** Remove the metal sleeve and rubber grommet from the OE housing and reinstall them into the new aFe housing as shown (15).

**Step 22:** Install the new inlet seal onto the housing and secure it with the (3) three locking tabs across the top and the (2) two retaining clips on the sides (16).

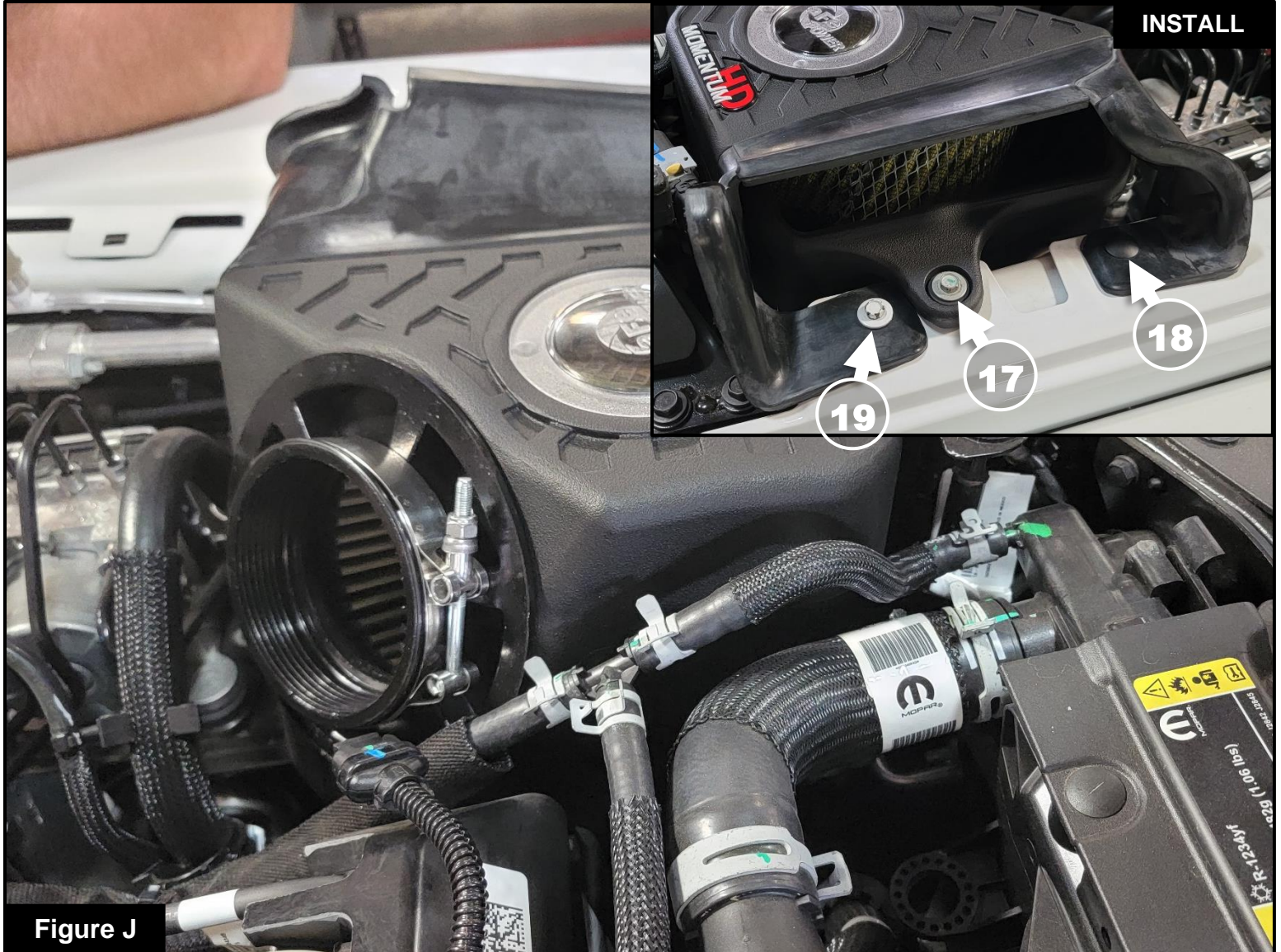

Figure J

**Refer to Figure J for Steps 23-26**

- Step 23:** Install the new aFe housing into the vehicle. Make sure that the mounting pins line up in the mounting grommets and then secure the housing to the fender using the screw removed in **Step 12** (17).
- Step 24:** Use a retaining clip to secure one side of the inlet seal to the fender (18).
- Step 25:** If desired, remove the painted bolt under the other side of the inlet seal and use it to secure the inlet seal to the fender (19). **Note:** Some paint may chip off of the screw or the fender during this step, so proceed at your own discretion. An alternative is to tuck the tab underneath the fender.
- Step 26:** Install the new aFe air filter into the housing and position the clamp loosely as shown. Make sure the locking tabs on the filter are secure by tugging on the filter.



Figure K

## **Refer to Figure K for Steps 27-29**

**Step 27:** Install the aFe intake tube into the vehicle. Slide the aFe intake tube into the filter and then rotate the coupling onto the turbo inlet pipe.

**Step 28:** Align the aFe intake tube so that the mounting grommet snaps onto its post.

**Step 29:** Position the two larger clamps at the coupling as shown and tighten them with an 11mm deep socket or hollow shaft nut driver. Do not overtighten.



Figure L

**Refer to Figure L for Steps 30-34**

**Step 30:** Install the CCV hose into the coupling (20) so there is no gap between the face of the coupling and the CCV hose.

**Step 31:** Using an 8mm nut driver or flat-head screwdriver, tighten the mini clamp to secure the CCV hose to the coupling.

**Step 32:** Reconnect the Temp sensor wire harness to the Temp sensor on the CCV hose (21).

**Step 33:** Reconnect the MAF sensor harness to the MAF sensor on the aFe intake tube (22).

**Step 34:** Position the large clamp on the filter as shown and tighten the clamp to secure the aFe intake tube to the aFe filter.



**Figure M**

**Refer to Figure M for Steps 35-36**

**Step 35:** Reinstall the engine cover into the vehicle. Make sure the pins are properly aligned and secure it with the two screws removed in **Step 1**.

**Note:** If the engine cover is touching the MAF sensor harness, you may need to loosen the clamps on the coupling, push the tube down lower, and then retighten the clamps.

**Step 36:** Check all the components are tight and secure. Your installation is now complete. Thank you for choosing aFe POWER!

**NOTE:** Check all screws, clamps, and connectors are secure after 100-200 miles.





**Page left blank intentionally**



**Page left blank intentionally**



**Page left blank intentionally**

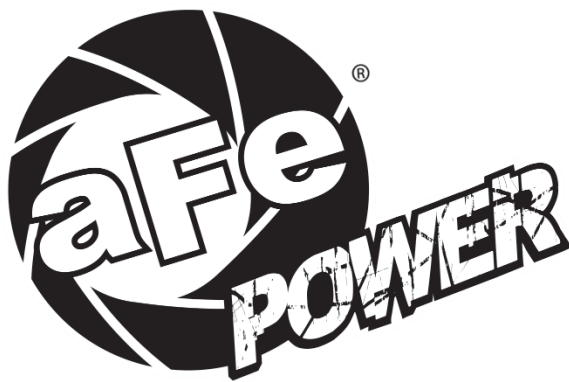

***advanced FLOW engineering, inc.***

252 Granite Street Corona, CA 92879

<https://afepower.com/contact>