

aFe CONTROL

Sway Bar Set

2020+ Toyota GR Supra

Product Number: 440-721001-L, 440-721001FL, 440-721001RL

Install Time: 5 hrs. (Full Kit), 1 hr. (Front Kit), 4 hrs. (Rear Kit)



Full Kit Contents	Front & Rear Sway Bar Set	Qty.
00P-0P2505-L	Bar, Front Sway: 2020 Supra	1
00P-0P2506-L	Bar, Rear Sway: 2020 Supra	1
00P-0P2511-B	Bracket, Type 4 S/B (Black Anodize)	2
00P-0P2510-B	Bracket, Type 2 S/B (Black Anodize)	2
00P-0C1657-B	Bushing, Poly: 1.125"ID	2
00P-0C1696-B	Bushing, Poly: 0.875"ID 5337G	2
00P-0C1175-A	Fitting, Grease: 1/4-28 Self Tap	2
00P-0C1697-A	Fitting, Grease: 1/4-28 Self Tap 90°	2
00P-0C1698-A	Cap, Grease Fitting	4
00P-0C1007-A	Packet, Grease: Poly Bushing (0.5 oz)	1

Recommended Tools:

Sockets: 8mm, 10mm, 13mm, 16mm, 18mm, T30 Torx, E12 Torx, E14 Torx, E18 Torx
Wrenches: 16mm

Preferable Equipment:

- 2-Post Lift
- Hydraulic Transmission Jack
- Screw Jack

Front Sway Bar Installation:

- 1F Raise the vehicle with a 2-post lift (preferable), or floor jack. If using a floor jack, place jack stands in the factory designated jack points. You do not need to remove the front wheels for the front installation.



- 2F Remove the (3) front plastic covers. (8mm socket)

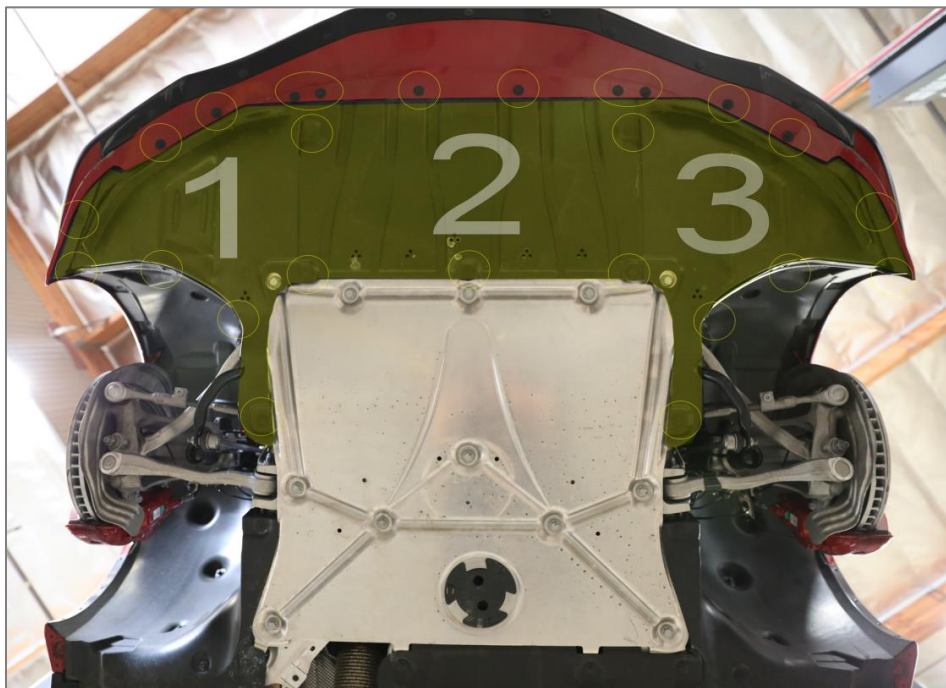

3F Remove the aluminum cover. (16mm socket)

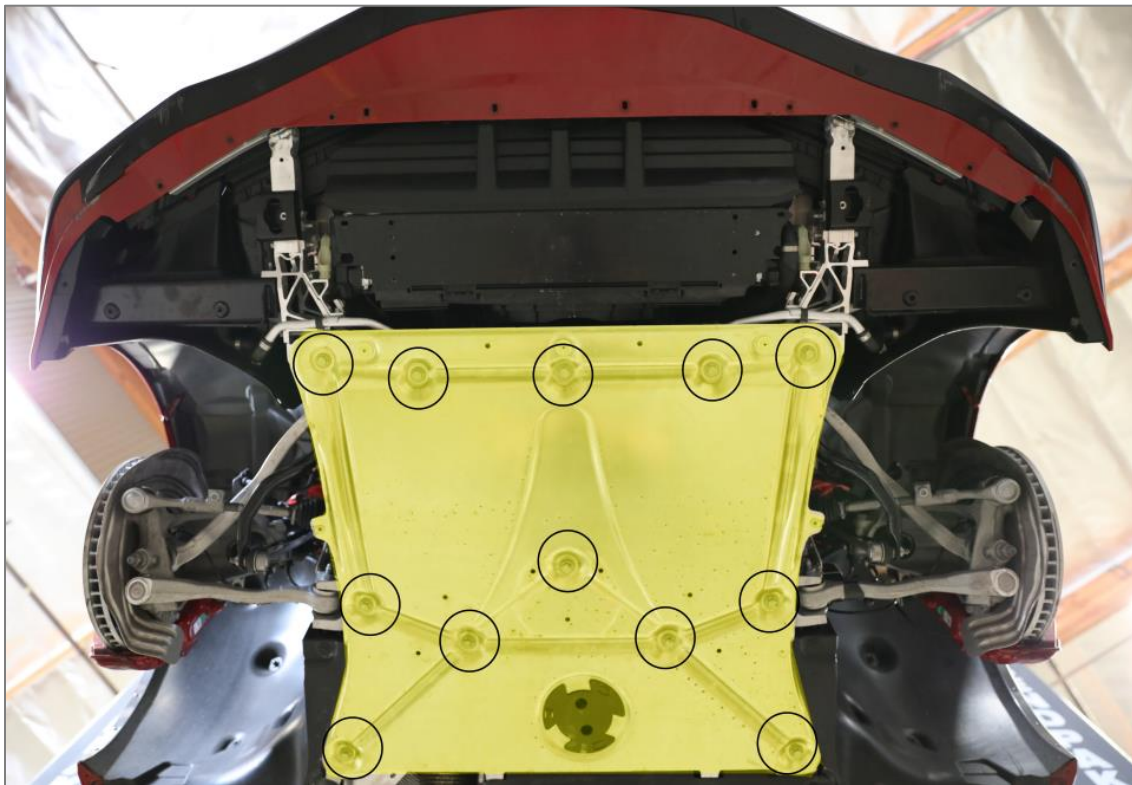

Front sway bar exposed.

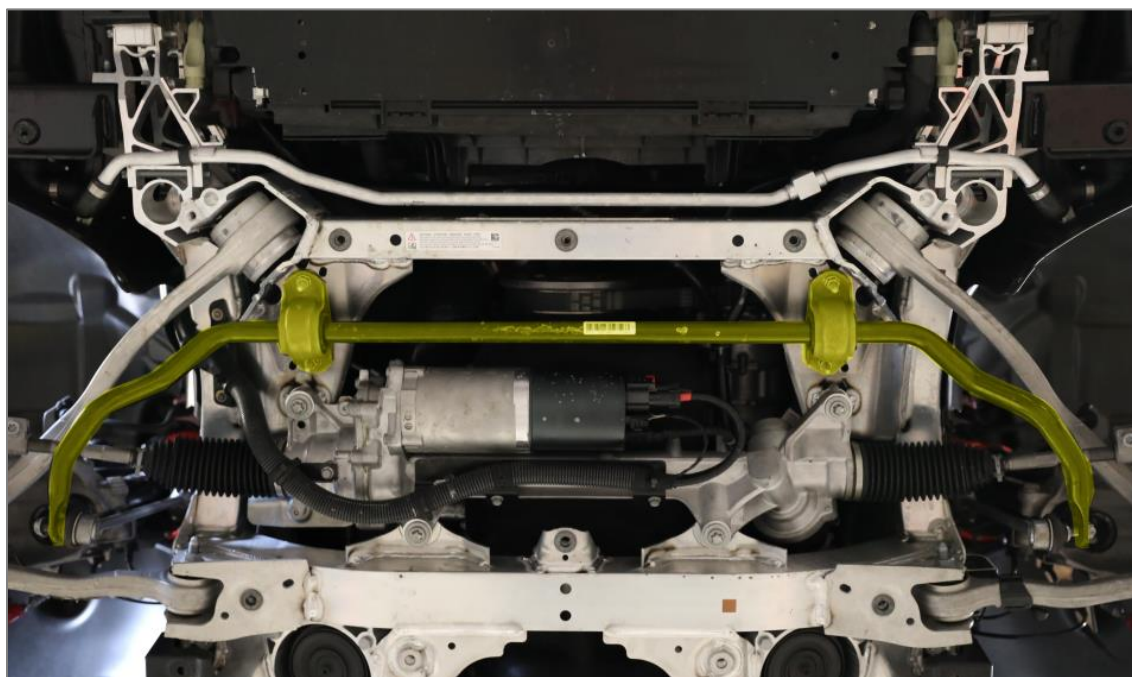

- 4F Disconnect the end links from the stock sway bar using a T30 torx socket for the stud and 16mm wrench for the nut.

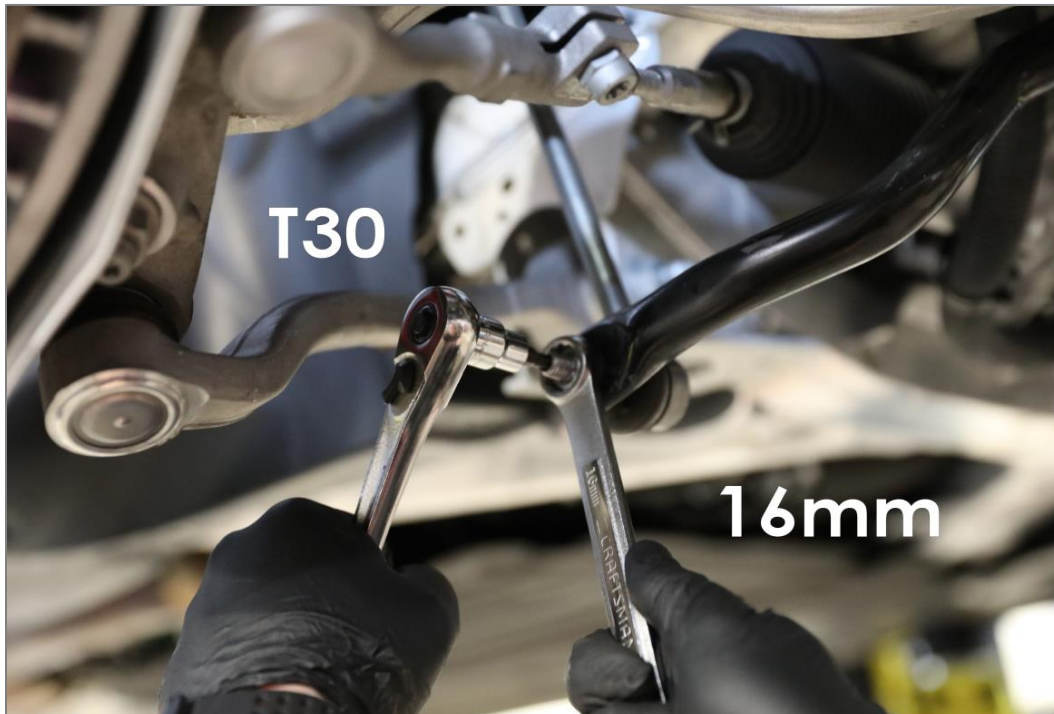

- 5F Undo the sway bar bushing brackets. (13mm socket)

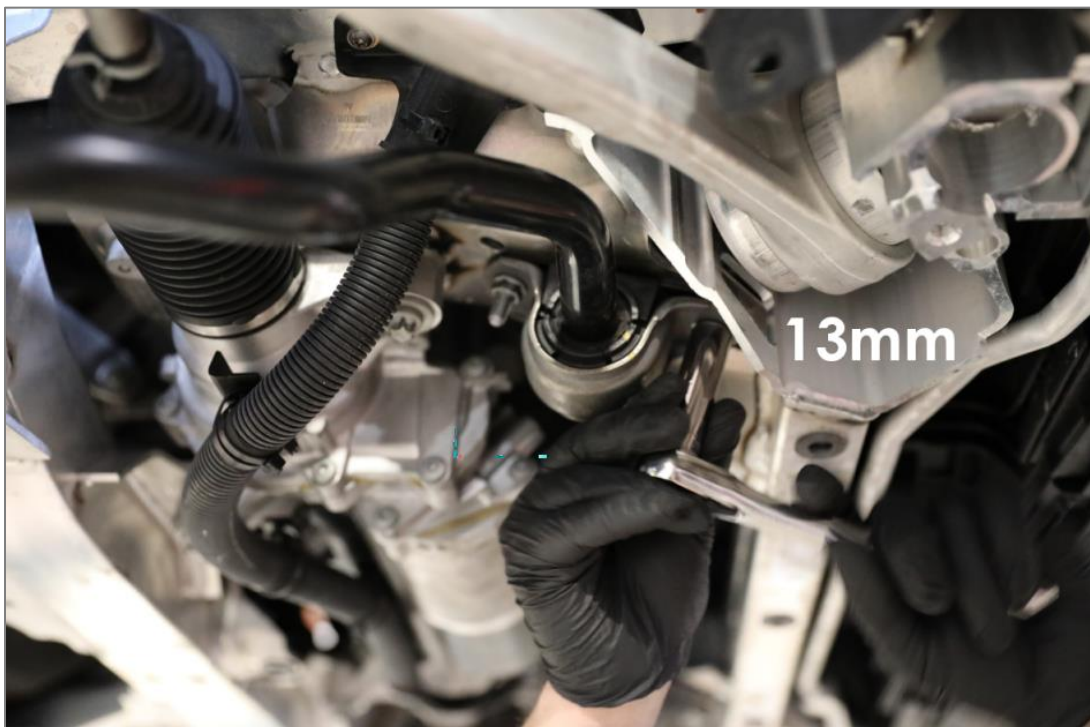

- 6F Remove the factory sway bar from the vehicle. Note the orientation of the sway bar when removing. (i.e. observe which is the top of the sway bar and how the ends are pointing.)

Be careful not to lose the factory base plates that reside between the bushing and the aluminum subframe. These will be reused.



- 7F Lay out the factory sway bar with the aFe Control sway bar to match the orientation.



8F Grease the front bushings with the supplied silicone lube and install bushings onto the sway bar. The bushings should be positioned just outside of the centering rings.

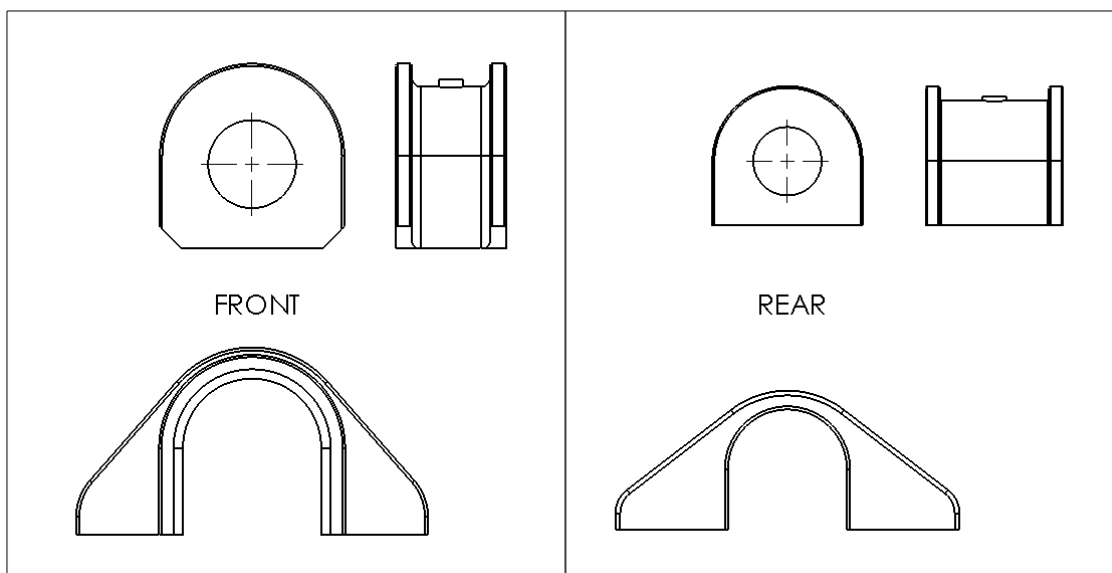

- 9F Install the front aFe Control sway bar in the same manner as factory removal. Place the factory base plate up to the subframe studs. Slide the aFe Control bushing bracket onto the bushings and mate the sway bar assembly to the subframe. Reuse the factory nuts to secure the brackets to the subframe. Fully tighten this hardware to **15 ft·lbs**.

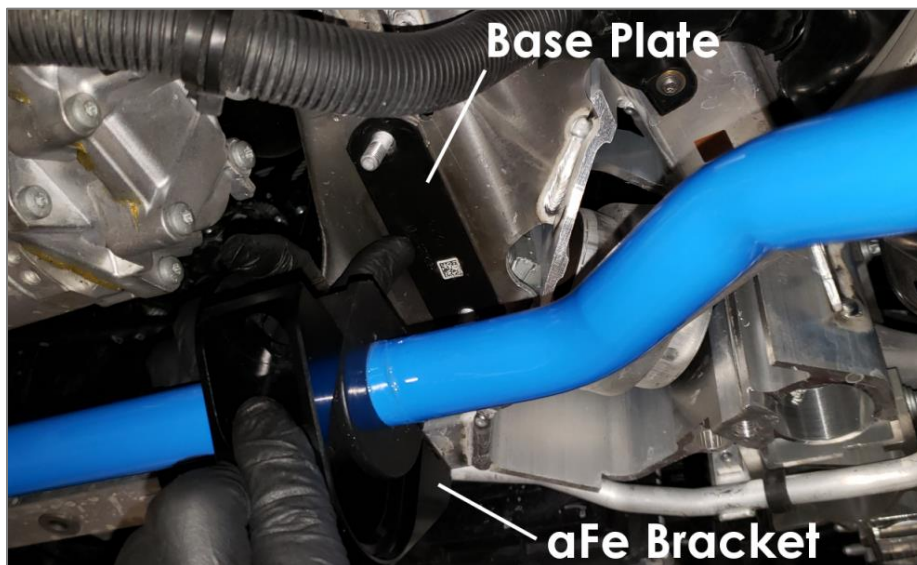

- 10F Reattach the end links to the sway bar ends reusing the factory nuts. The hole closest to the end is the softest setting. Settings get stiffer as you move away from the ends. For factory end links, tighten to **41 ft·lbs** (optional: apply thread locking compound to the end link thread)



- 11F Perform steps 1F-3F in reverse order. You are finished with the front installation.

Rear Sway Bar Installation:

Preface: The rear sway bar is located between the unibody and the rear subframe, so the difficulty level of this install is above average. Removal of the exhaust system (cat back), some plastic paneling, and dropping the rear subframe is required. Professional installation is recommended.

- 1R Raise the vehicle with a 2-post lift (preferable), or floor jack. If using a floor jack, place jack stands in all four of the factory designated jack points.



- 2R Remove the rear wheels.

3R Remove the (9) under-panels (8mm & 10mm sockets)

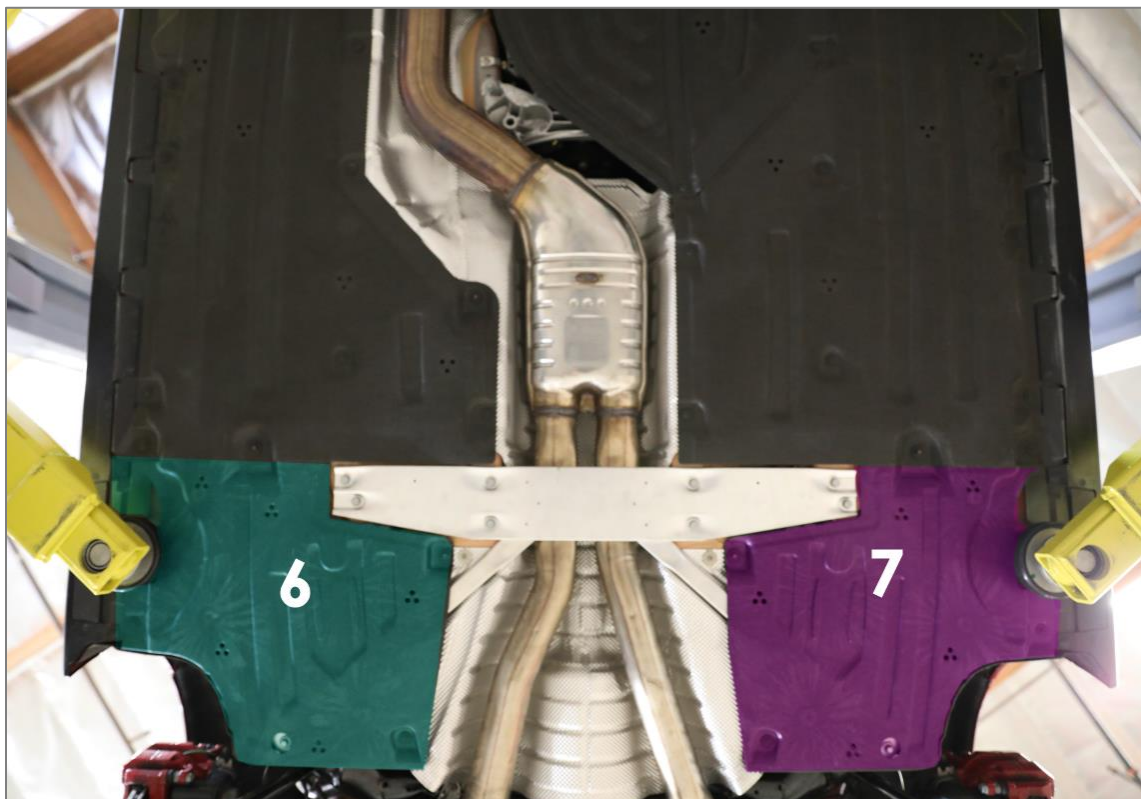
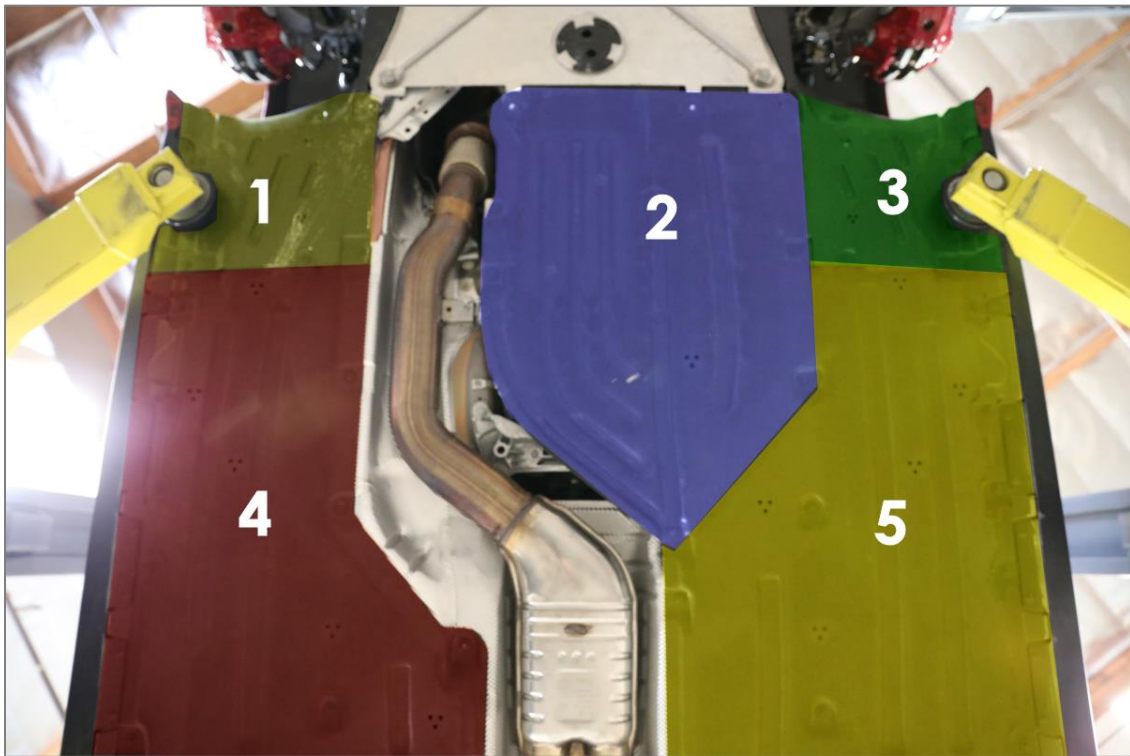

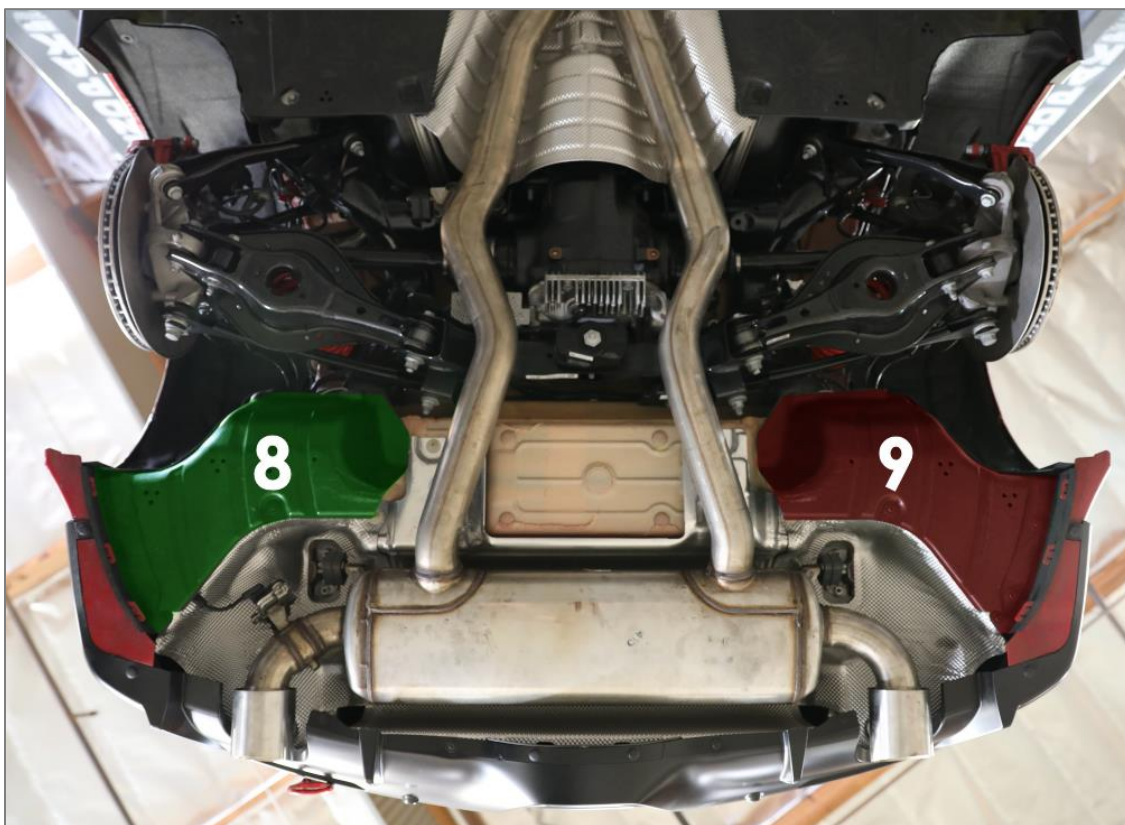

4R Remove the aluminum under brace (13mm & E14 torx sockets)

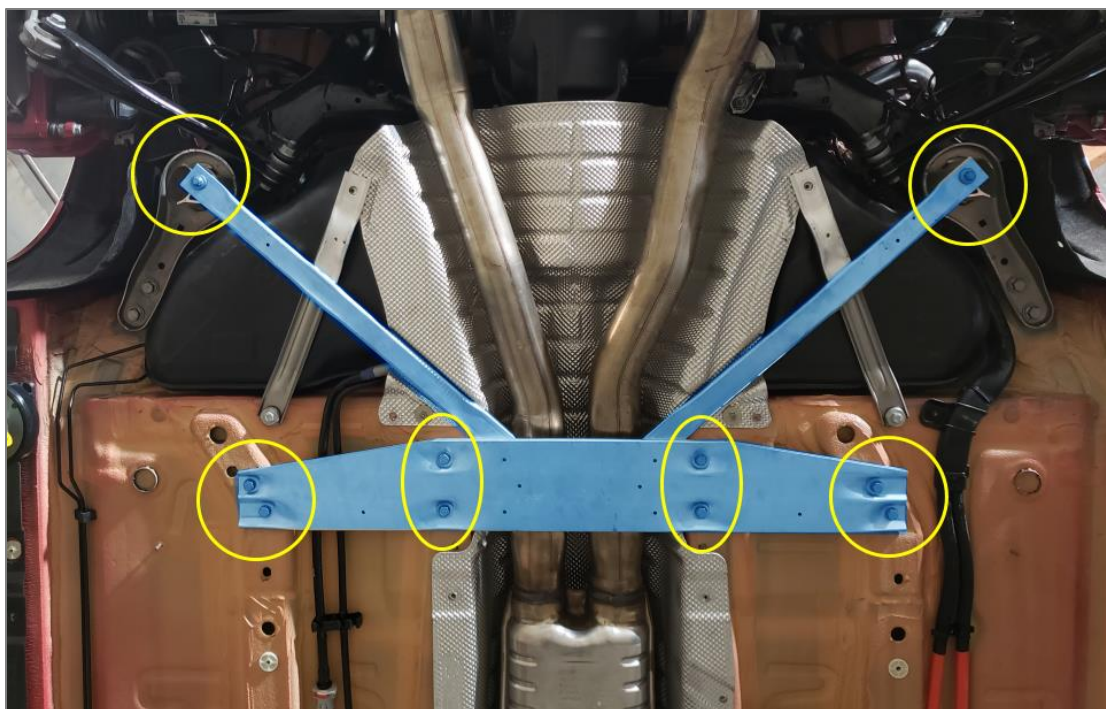

- 5R Remove the exhaust system starting just after the catalytic converter. Mounts and clamp can be removed with a 13mm socket.

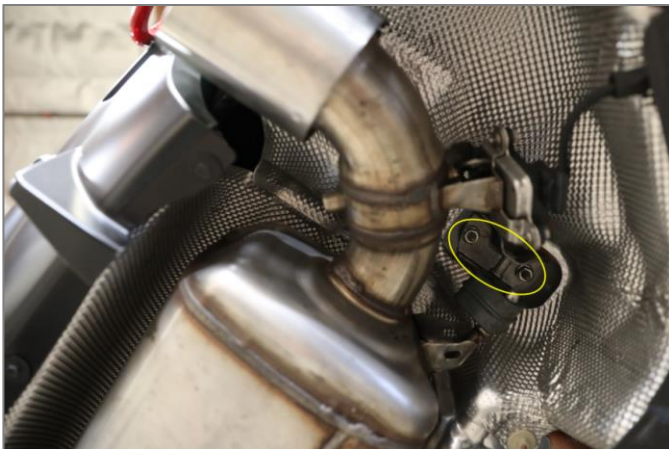
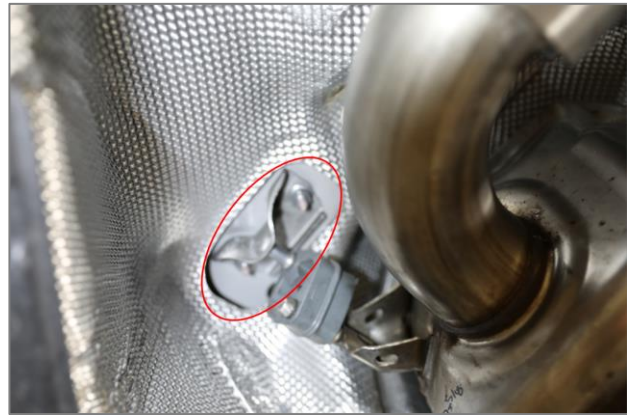
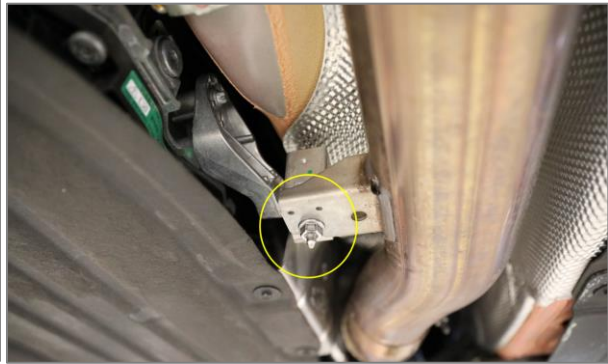
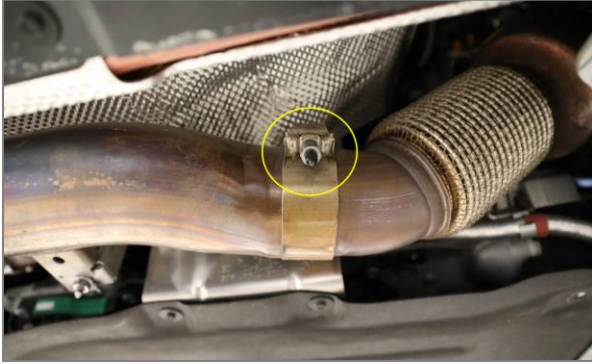

Unclip the exhaust valve.

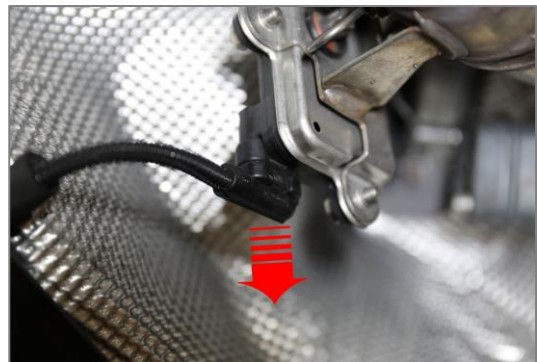



6R Undo the plastic nuts to remove the heat shield (10mm socket)

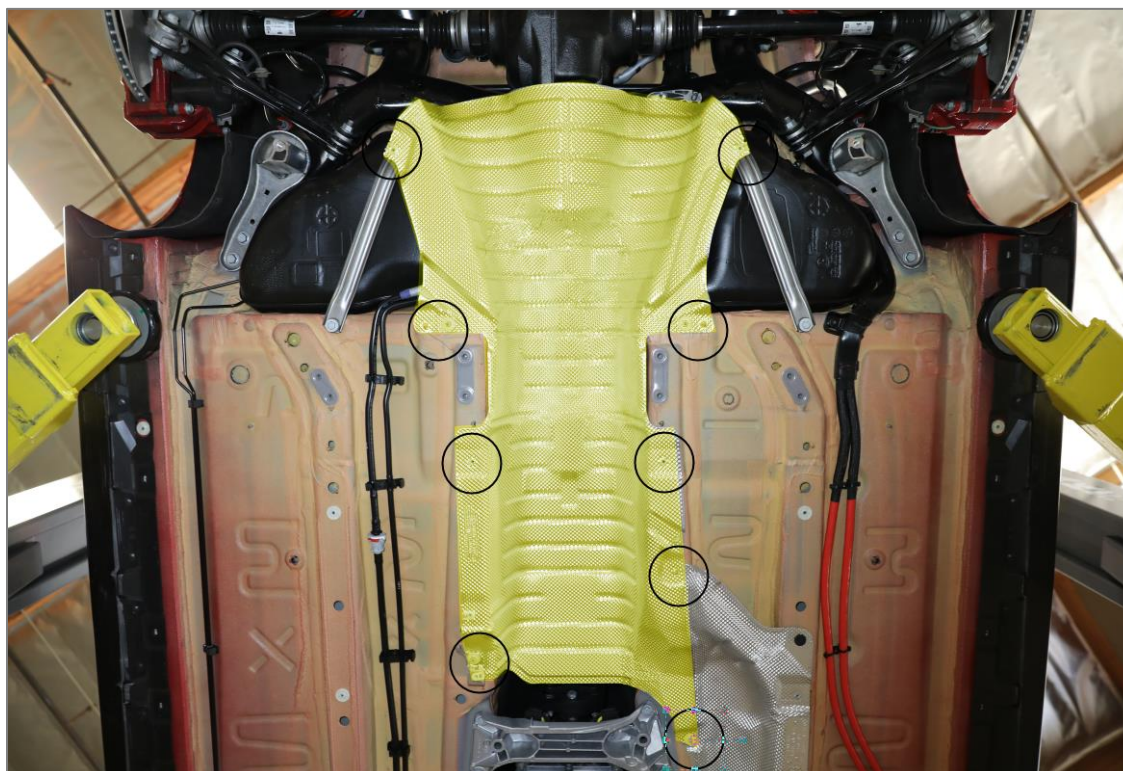

- 7R By hand, unclip the brake lines and ABS lines from their tab holders. Do not open any brake or abs lines. This allows some slack for the lines when you drop the subframe.

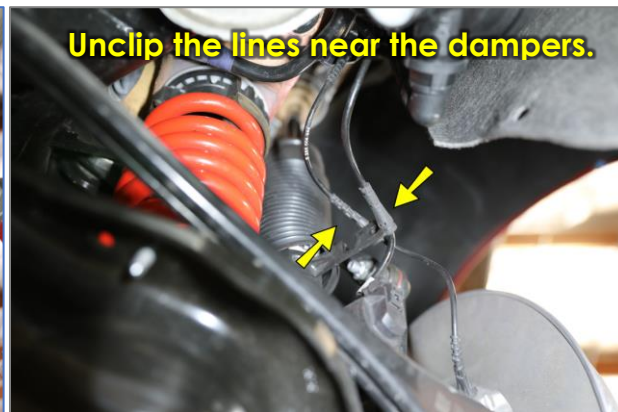
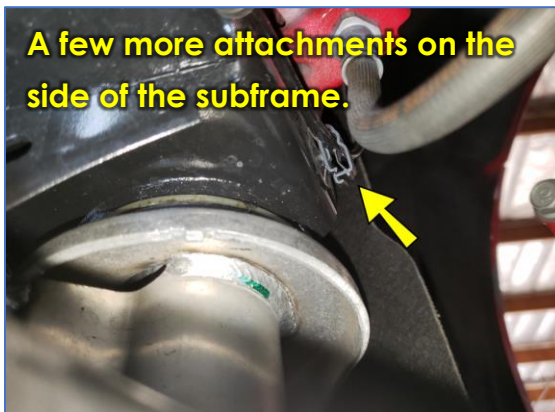
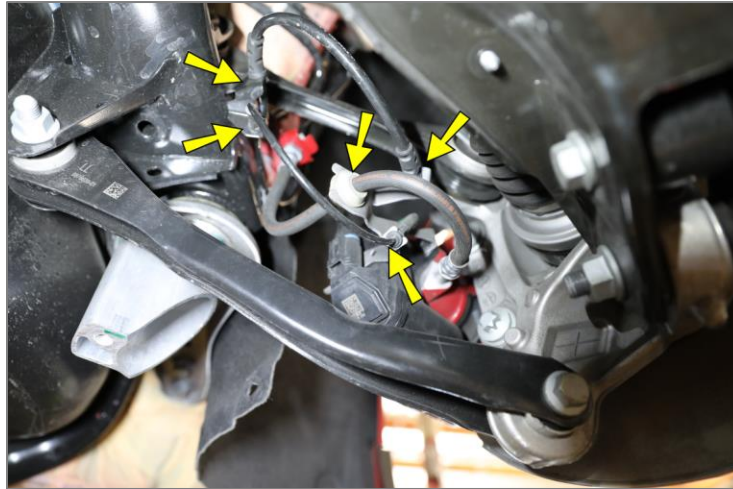

Unclip the electronic damper connector for each rear shock.

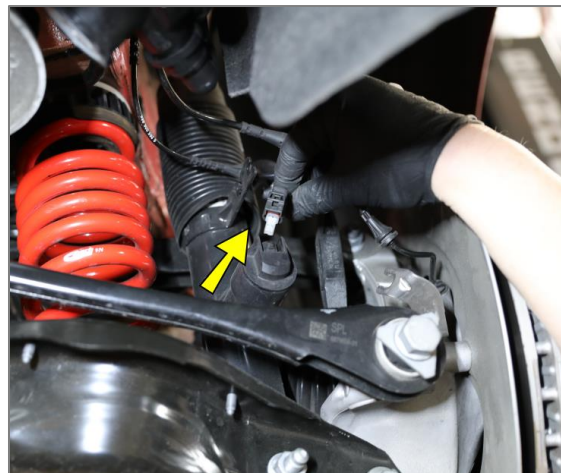

8R Disconnect the ground strap located on left side of diff. (10mm socket)

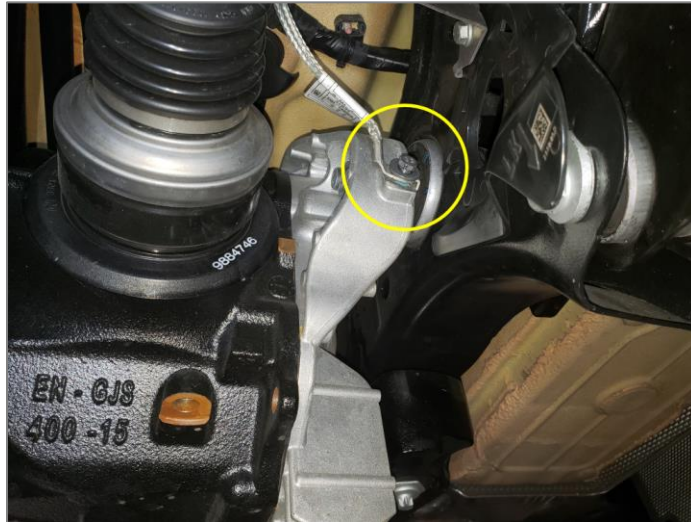

9R Disconnect the height sensor and all the line clips holding it to the subframe.

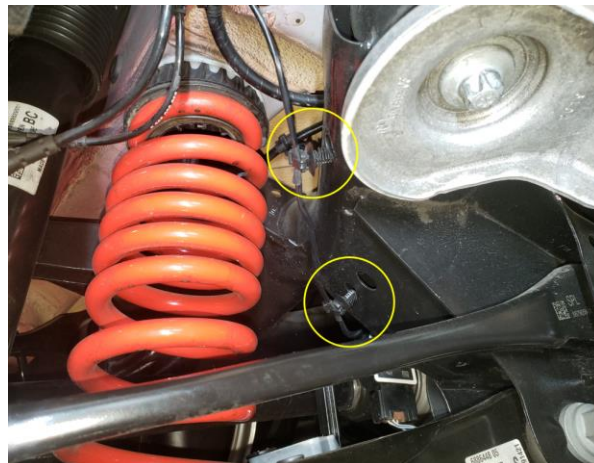

10R Detach the harness clip attaching the active differential wires to the subframe on the right side of diff.



11R Unbolt the lower shock mounts. (18mm socket & wrench)



- 12R Using chains or straps, secure the subframe to a lifting device (e.g. transmission jack). Have the transmission jack apply some support force to hold the anticipated weight of the subframe.



- 13R Next, unfasten the (4) main subframe mounts. Unbolt the hex bolts (16mm socket) from each of the four mounts first. Use an E18 torx socket and unfasten each of the (4) subframe main bolts.

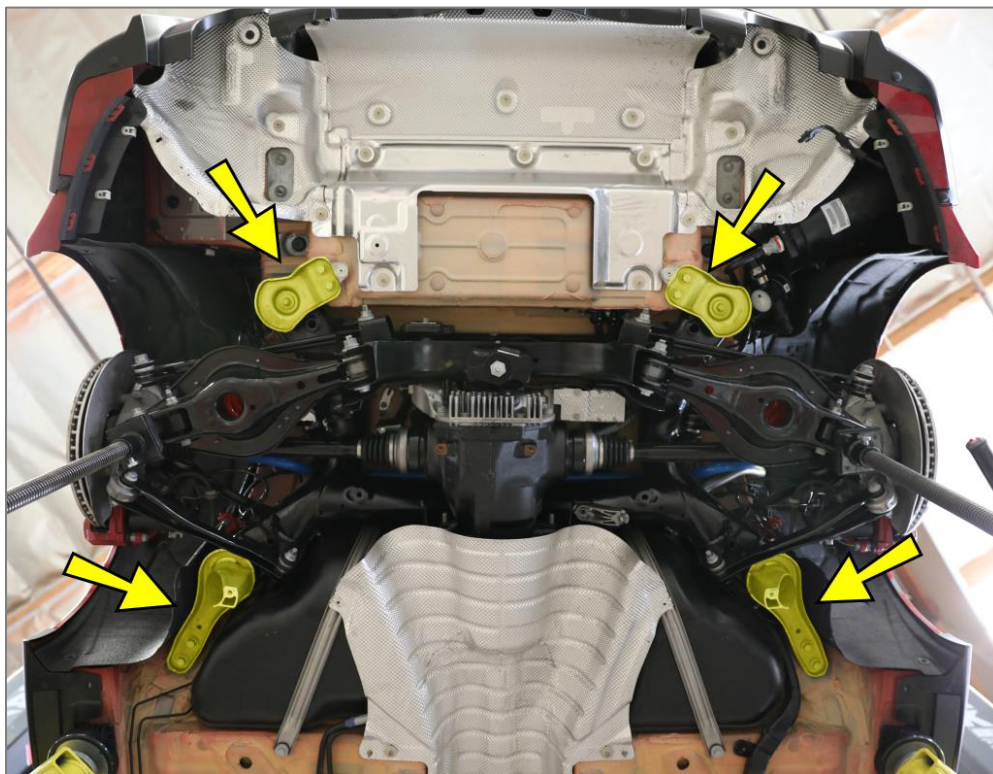

- 14R Lower the transmission jack slowly and check to make sure none of the lines are being tugged or pulled. If everything looks safe, lower the subframe about 4 inches or until there is enough room to sneak the rear sway bar out.

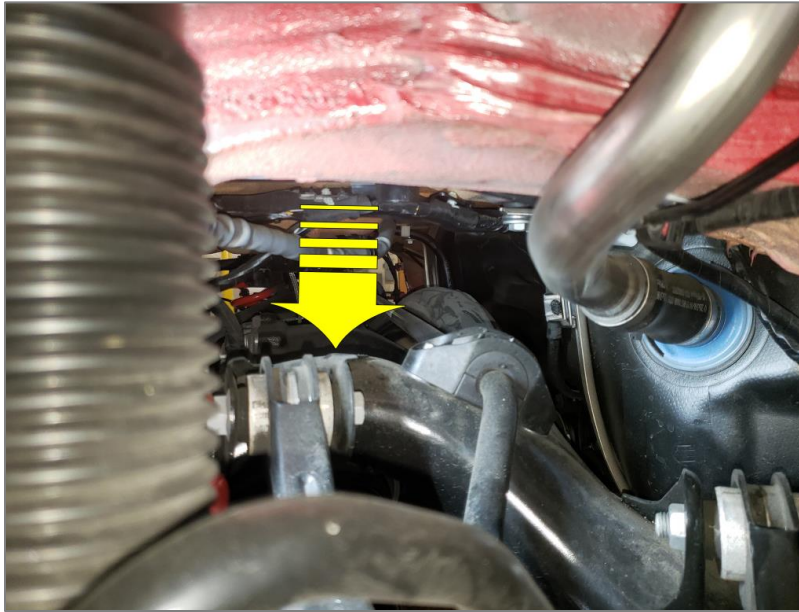

- 15R Disconnect the end links from the stock sway bar using a T30 torx socket for the stud and 16mm wrench for the nut.



16R Undo the sway bar bushing brackets. (E12 torx socket)

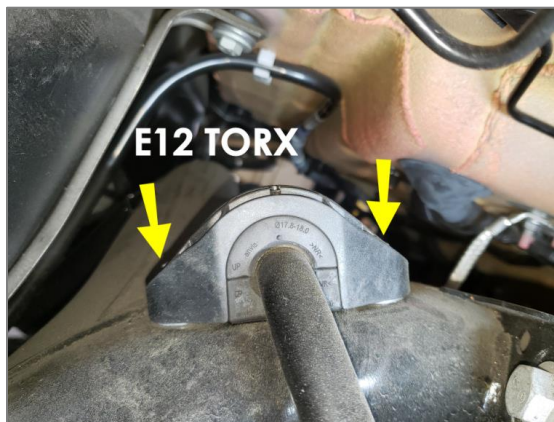

17R Remove the factory sway bar from the left side of the vehicle. Note the orientation of the sway bar when removing. (i.e. observe which is the top of the sway bar and how the ends are pointing.)



18R Lay out the factory sway bar with the aFe Control sway bar to match the orientation.



- 19R Grease the rear bushings with the supplied silicone lube and install bushings onto the sway bar. The bushings should be positioned just outside of the centering rings.

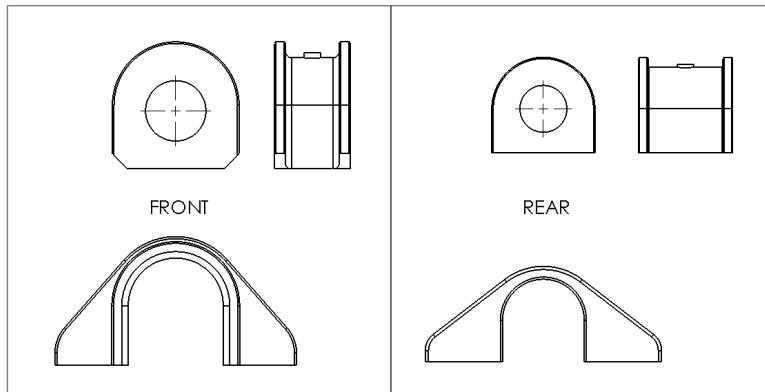

- 20R Install the rear aFe Control sway bar in the same manner as factory removal.



- 21R Slide the aFe Control bushing bracket onto the bushings and mate the sway bar assembly to the subframe. Make sure the grease fittings are pointed outward. Reuse the factory torx bolts to secure the brackets to the subframe. Fully tighten this hardware to **16 ft·lbs**.

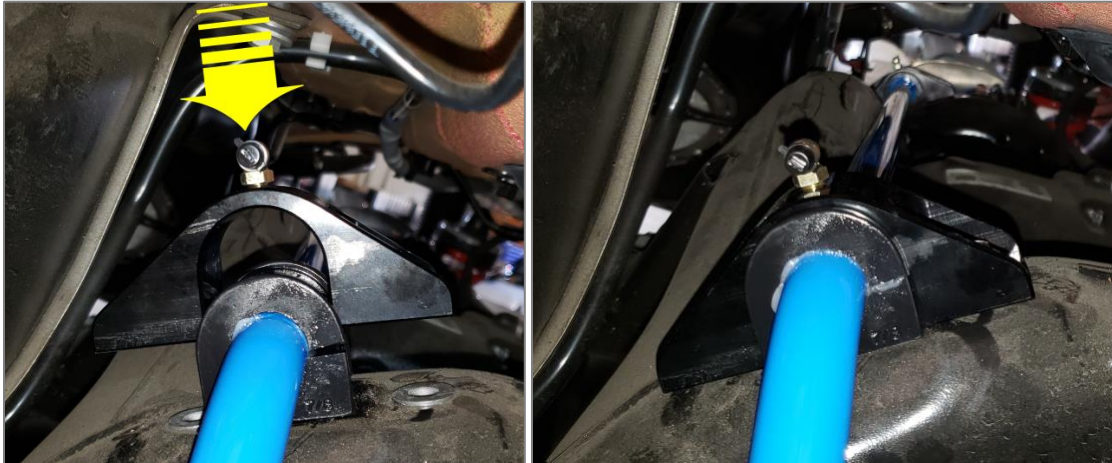

- 22R Reattach the end links to the sway ends reusing the factory nuts. The hole closest to the end is the soft setting. Settings get stiffer as you move away from the ends. For factory end links, tighten to **41 ft·lbs** (optional: apply thread locking compound to the end link thread)



- 23R Perform steps 1R-14R in reverse order. Key subframe torque specs below. You are finished with the rear installation.

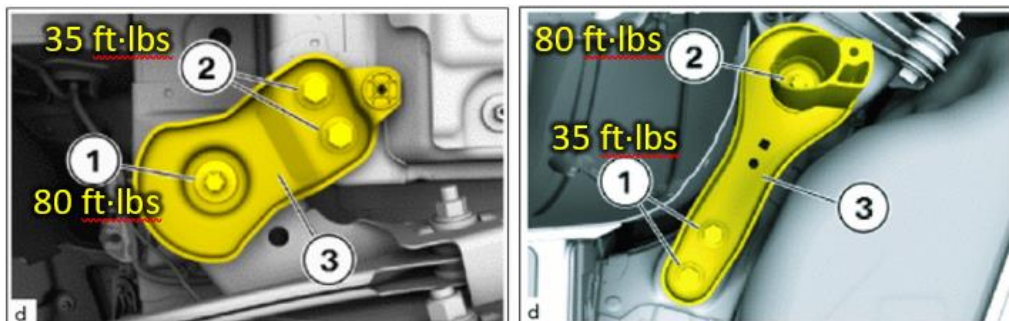

Stiffness Chart and Tuning:

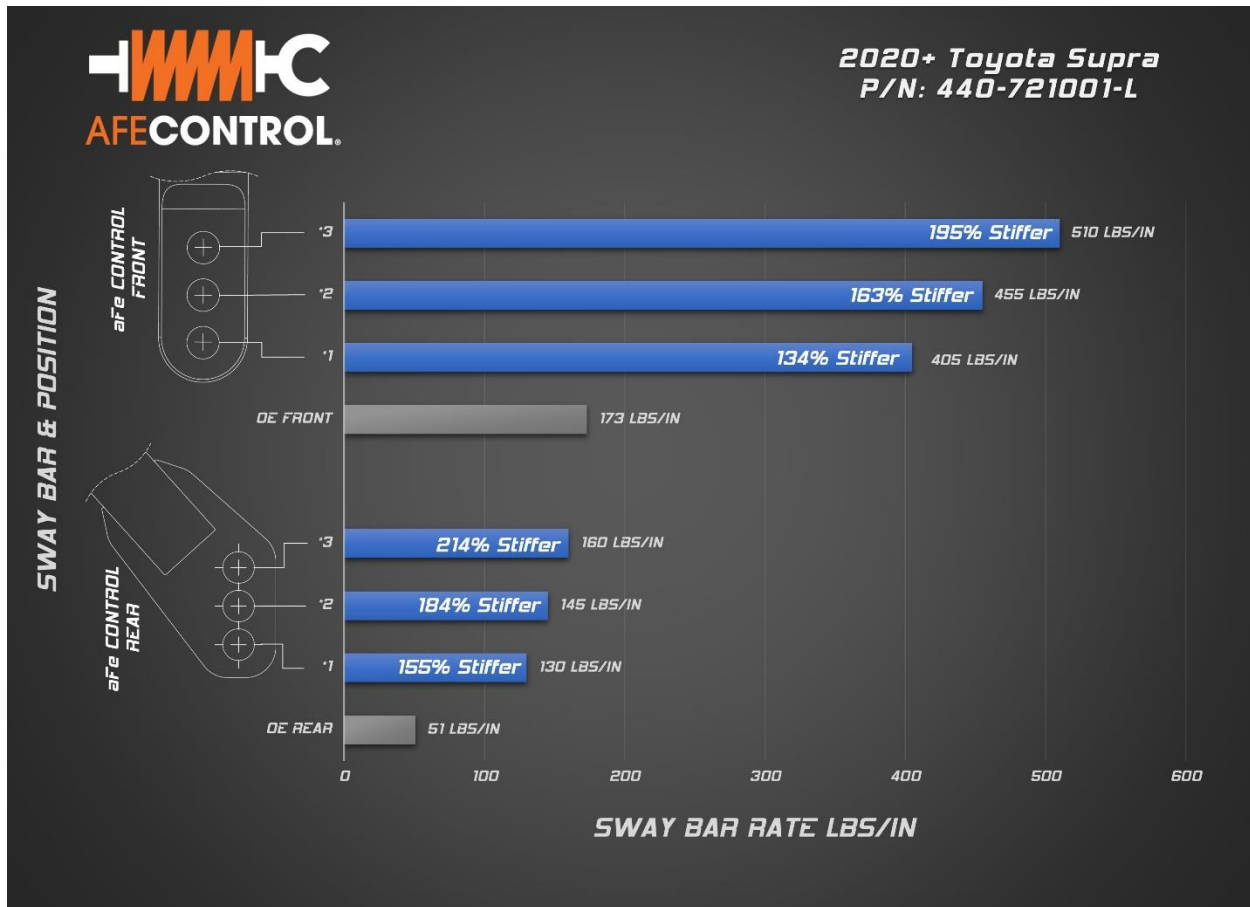

Stiffer roll resistance will demand more from the tires. When the tire's grip is overloaded, they will begin to slip. Manipulating when the front or rear tires slip can make the vehicle understeer, oversteer, or handle neutral. So, think of it as the higher the stiffness, the earlier the slip. If the front slips first, you will have understeer. If the rear slips first, you will have oversteer. If both front and rear slip near the same time, you will have neutral handling.

(Note: Handling characteristics highly depend on wheel alignment and how much grip your tires have)

Suggested Initial Settings:

Front: Position #3 Full Stiff

Rear: Position #1 Full Soft