

advanced FLOW engineering

Instruction Manual P/N: 51-76106 / 54-76106 / 75-76106

Make: **Nissan** Model: **Patrol (Y61)** Year: **2001-2016** Engine: **I6-4.8L (Engine: TB48DE)**



- Please read the entire instruction manual before proceeding.
- Ensure all components listed are present.
- If you are missing any of the components, call technical support at 951-493-7100 or e-mail tech@afepower.com.
- Ensure you have all necessary tools before proceeding.
- Do not attempt to work on your vehicle when the engine is hot.
- Disconnect both the negative battery terminal before proceeding.

Retain factory parts for future use.

Label	Qty.	Description	Part Number
A1	1	Pro 5R (Blue Media)	24-91109
A2	1	Pro DRY S (Gray Media)	21-91109
A3	1	Pro-GUARD 7 (Gold Media)	72-91109
B	1	Tube	05-76106B1
C	1	Housing	05-76106B2
D	1	Plug, Silicone	05-01429
E	1	Fitting	03-50150
F	1	Clamp, #052	03-50008
G	1	Clamp, T-bolt (SS)	03-50292
H	1	Coupling, Silicone Bellow	05-01404
I	2	Screw, T-25 Torx Btn Hd: M5x16mm	03-50511
J	2	Screw, Hex Hd: M6x20mm	03-50057
K	1	Gasket	05-01406
L	1	Clamp, T-bolt (SS)	03-50267
M	1	Hose, Vacuum: 5/32" ID	05-00122

Installation will require the following tools:

10mm & 8mm nut drivers, pliers, T20 & T25 drivers, 10mm & 11mm deep sockets & drivers and 10mm wrench.

Warranty Information available at <https://afepower.com/contact#warranty>

Note: Not legal for use in California. The use of this device in any on-road or off-road vehicles registered with the California Dept of Motor Vehicles (DMV) is strictly prohibited. Vehicle does NOT exist in the US.

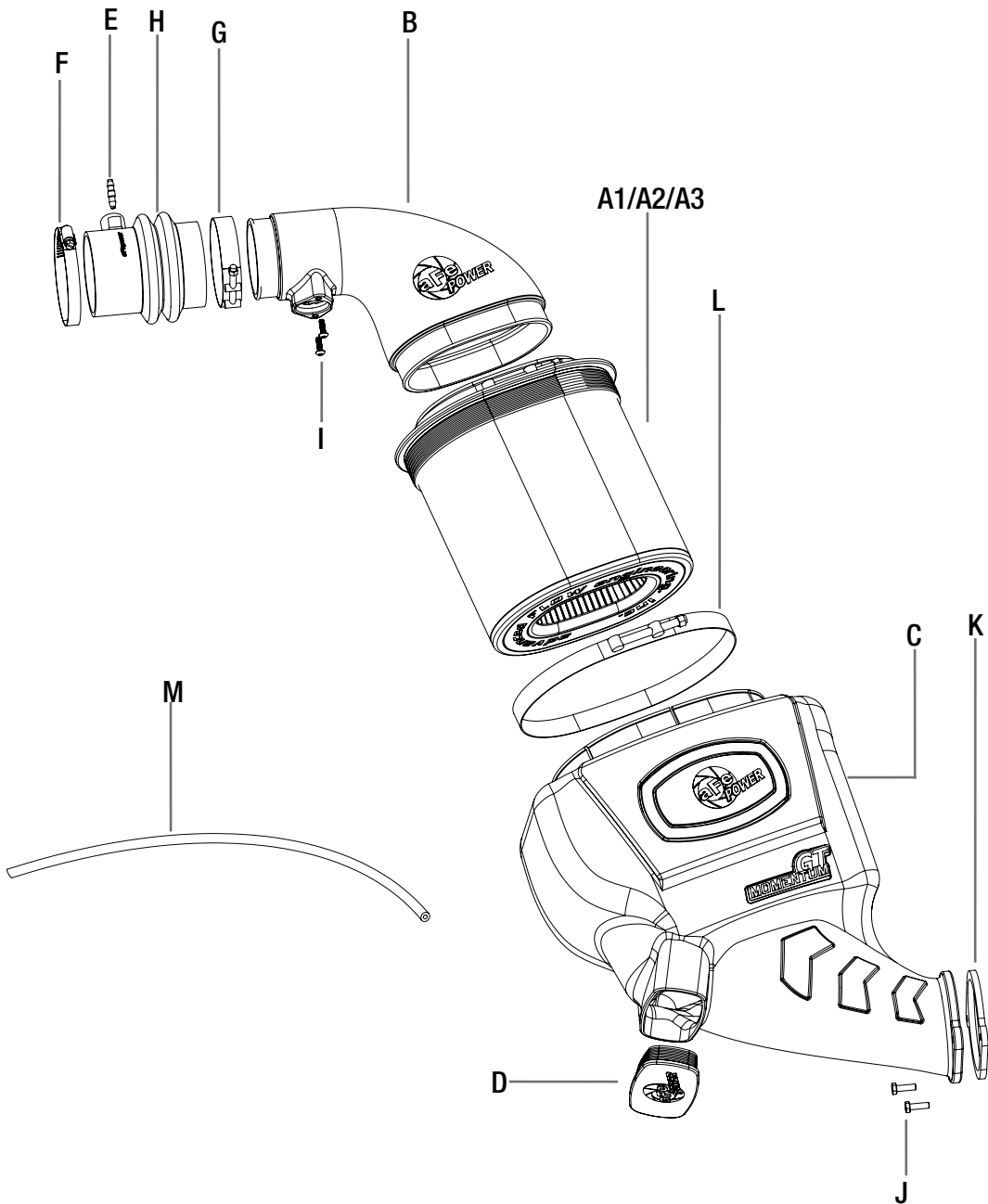

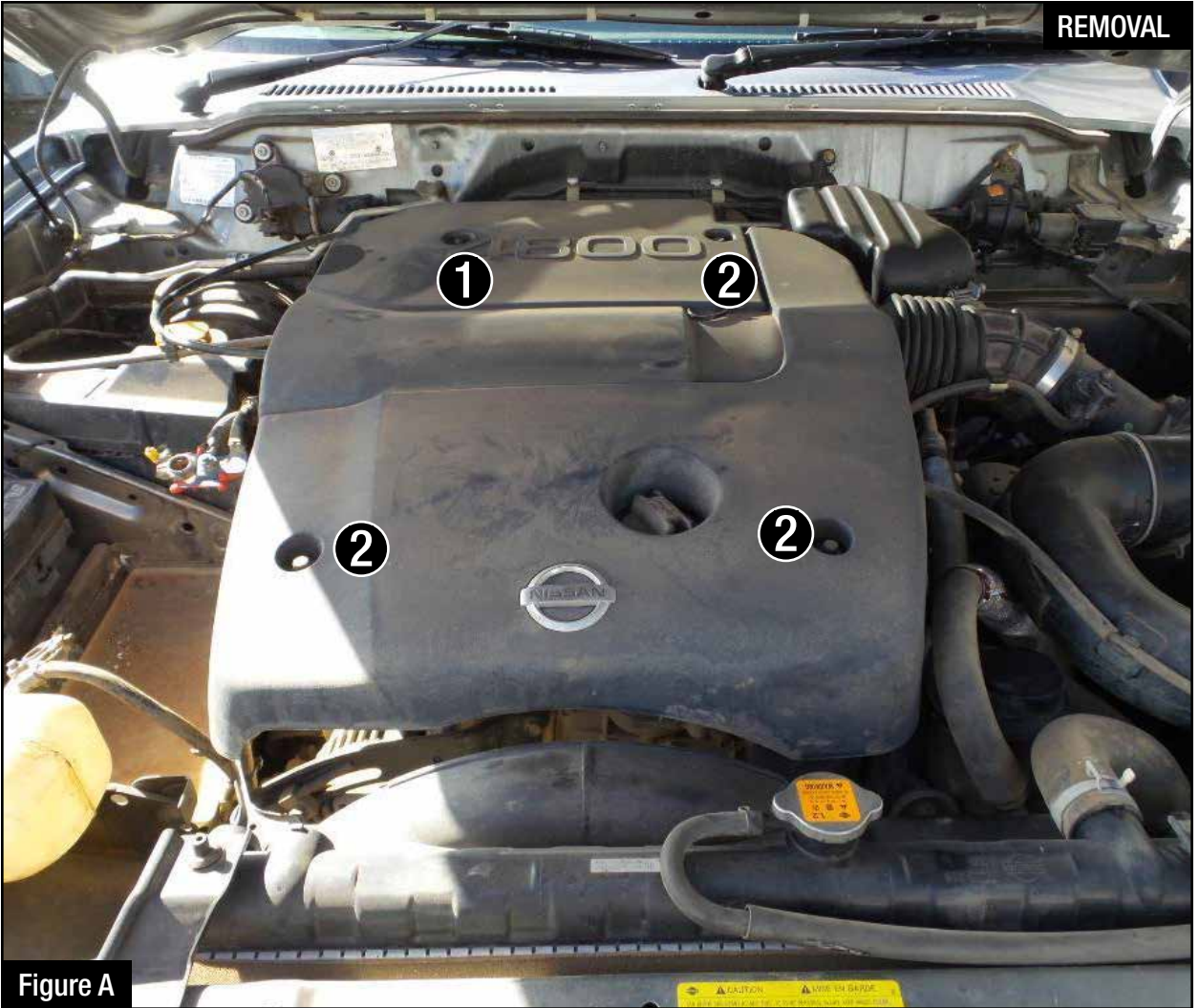
**Figure A****Refer to Figure A for Step 1**

Step 1: Use a 10mm nut driver to remove the rear nut (1) and three screws (2) holding the engine cover. Remove the engine cover and set aside.

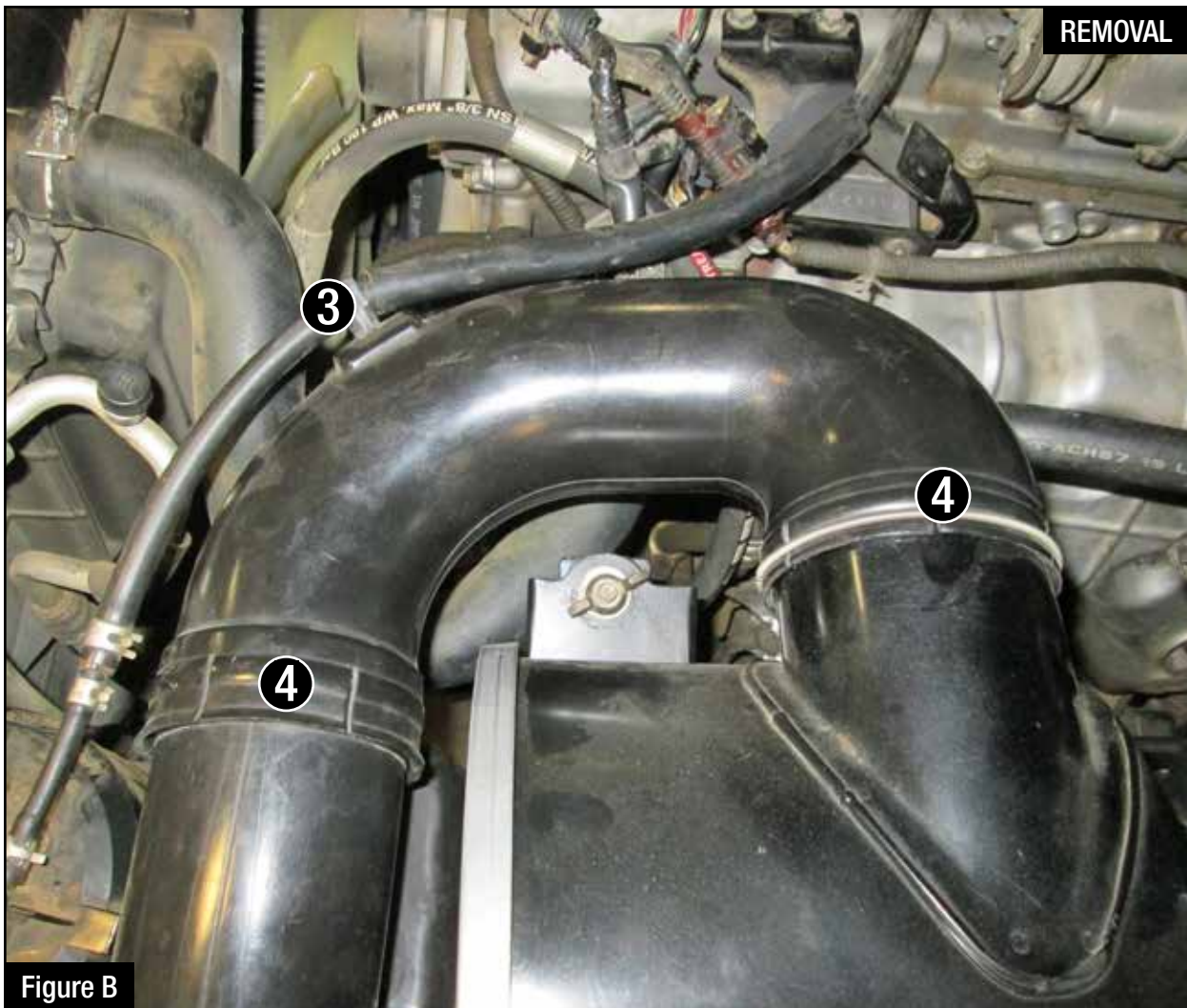
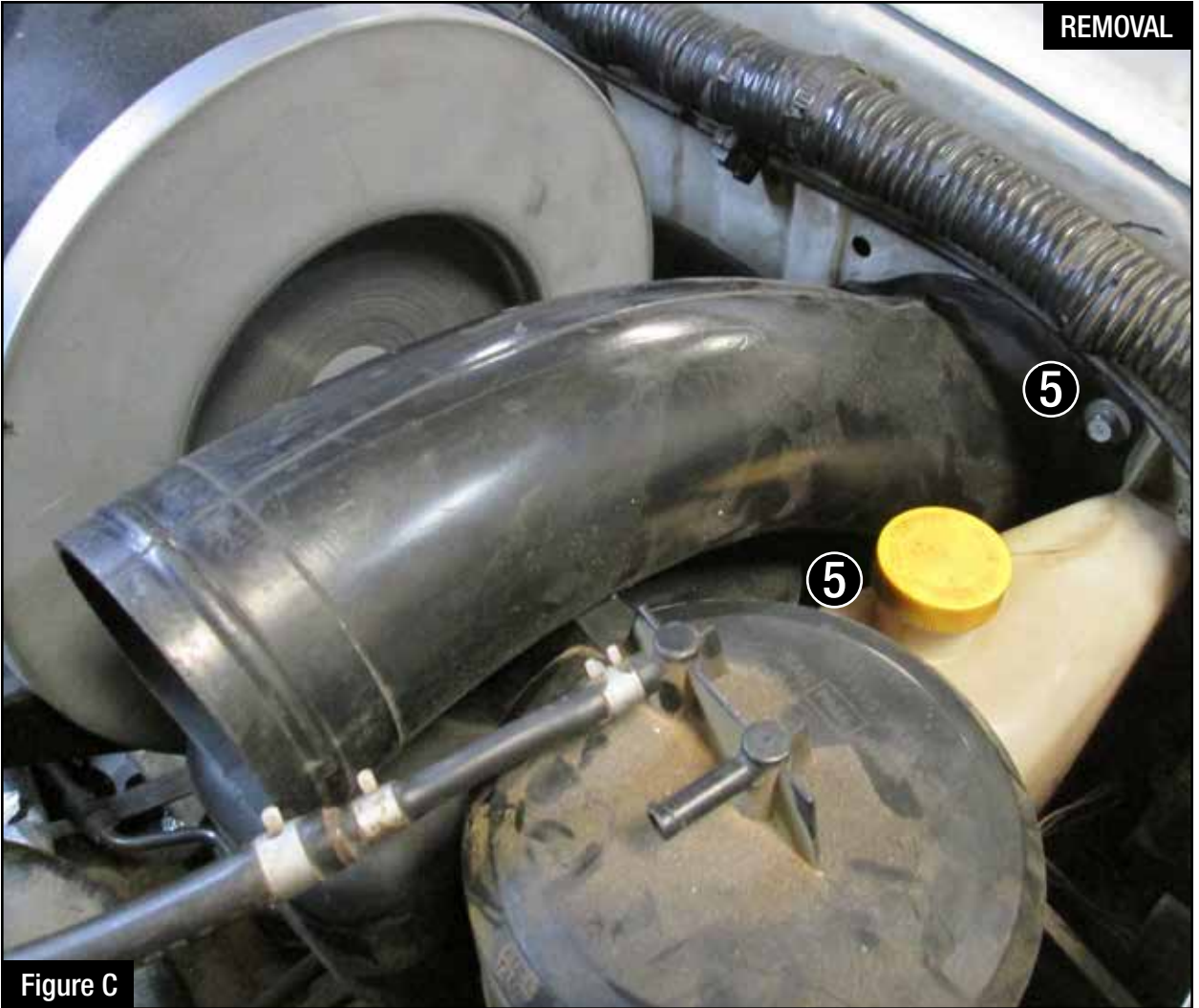

Figure B

Refer to Figure B for Step 2

Step 2: Remove the vacuum hose (3) from the retainer on the u-shape air duct. Push back on the lock springs (4) and remove the u-shape air duct from the air intake assembly.

**Figure C****Refer to Figure C for Step 3**

Step 3: Use a 10mm ratcheting wrench to remove the two screws ⑤ holding the air duct mounted on the side wall. Remove air duct by pulling it from its holding clip.

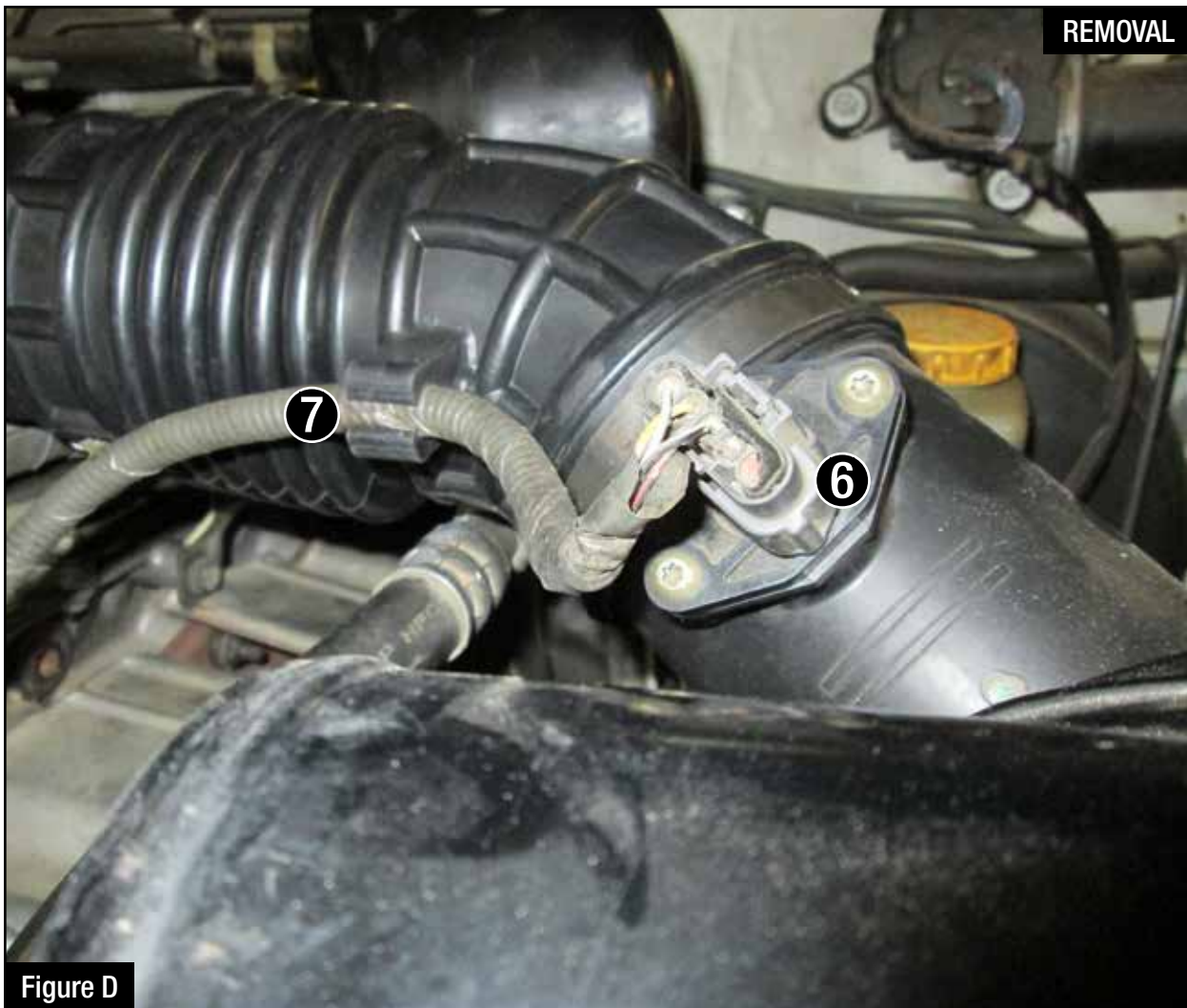

Figure D

Refer to Figure D for Step 4

Step 4: Disconnect the mass air flow sensor (6) and disengage the wire loom (7) from the air intake tube.

**Figure E****Refer to Figure E for Step 5**

Step 5: Use an 8mm nut driver to loosen the clamp (8) at the mass air flow sensor tube. Remove the two wing nuts (9) and two washers holding down the air cleaner assembly and remove the assembly.

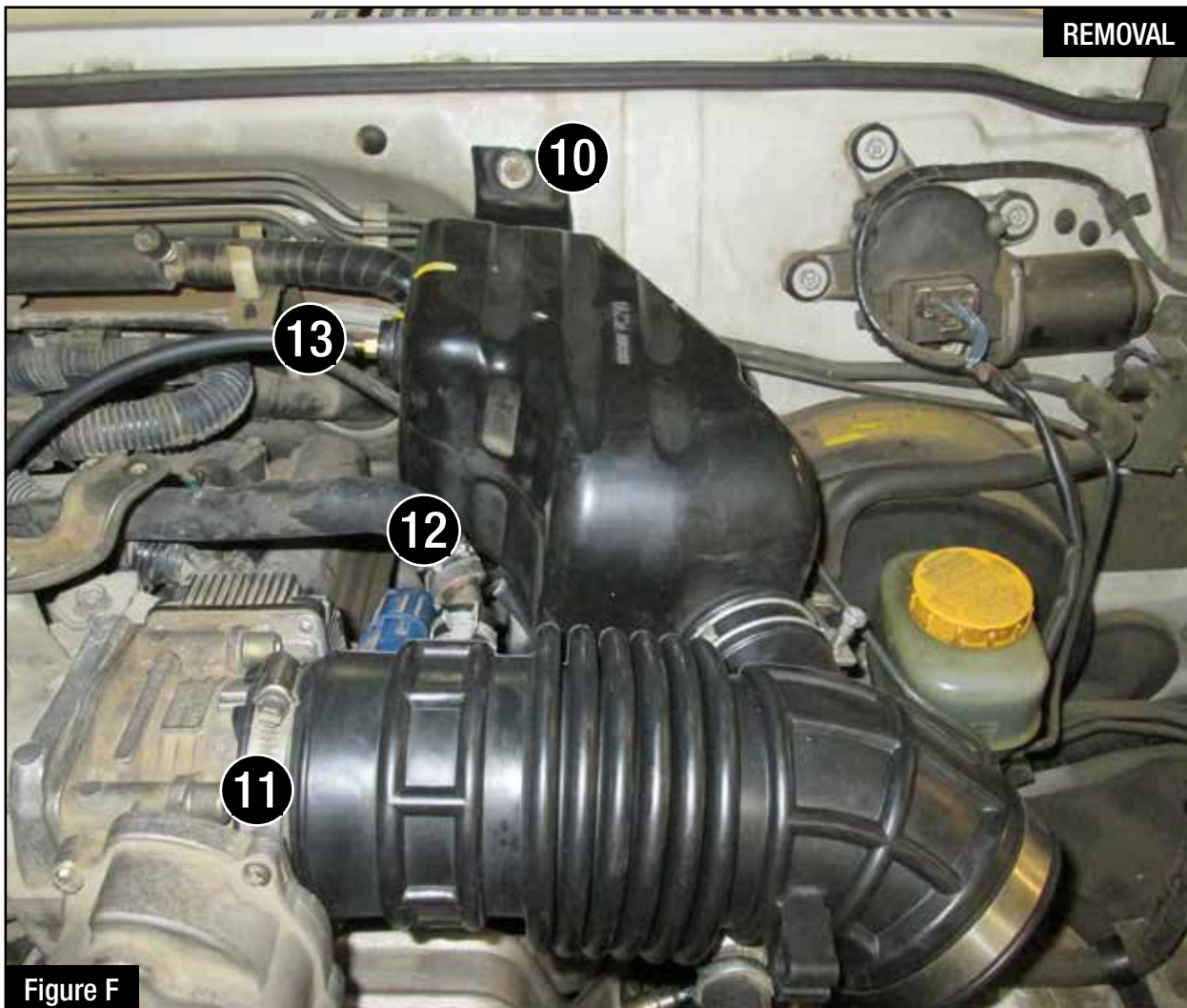

Figure F

Refer to Figure F for Step 6

Step 6: Use a 10mm nut driver to remove the screw (10) holding the air intake tube assembly resonator to the firewall. Use an 8mm nut driver to loosen the clamp (11) at the throttle body. Using pliers, remove the vent (12) hose to the air intake tube. Remove the small vacuum hose (13) from the air intake tube assembly resonator and the intake solenoid valve. Remove the complete air intake tube assembly.



Figure G

Refer to Figure G for Step 7

Step 7: Using a 10mm socket and driver, remove the two mounting brackets (14) from the engine bay.

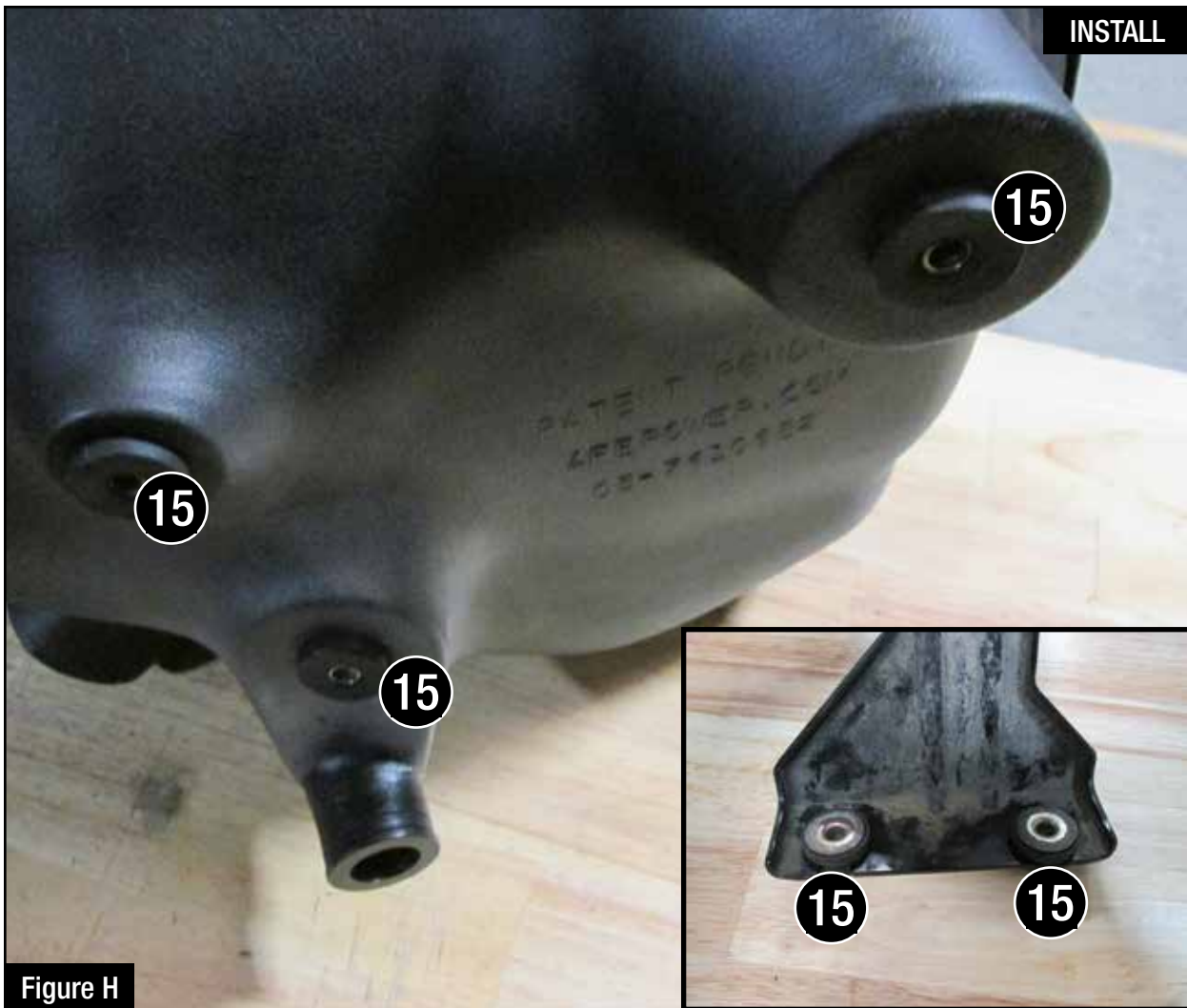

Figure H

Refer to Figure H for Step 8

Step 8: Remove three of the rubber grommets (15) and metal inserts from the mounting brackets and install them into the aFe air box.

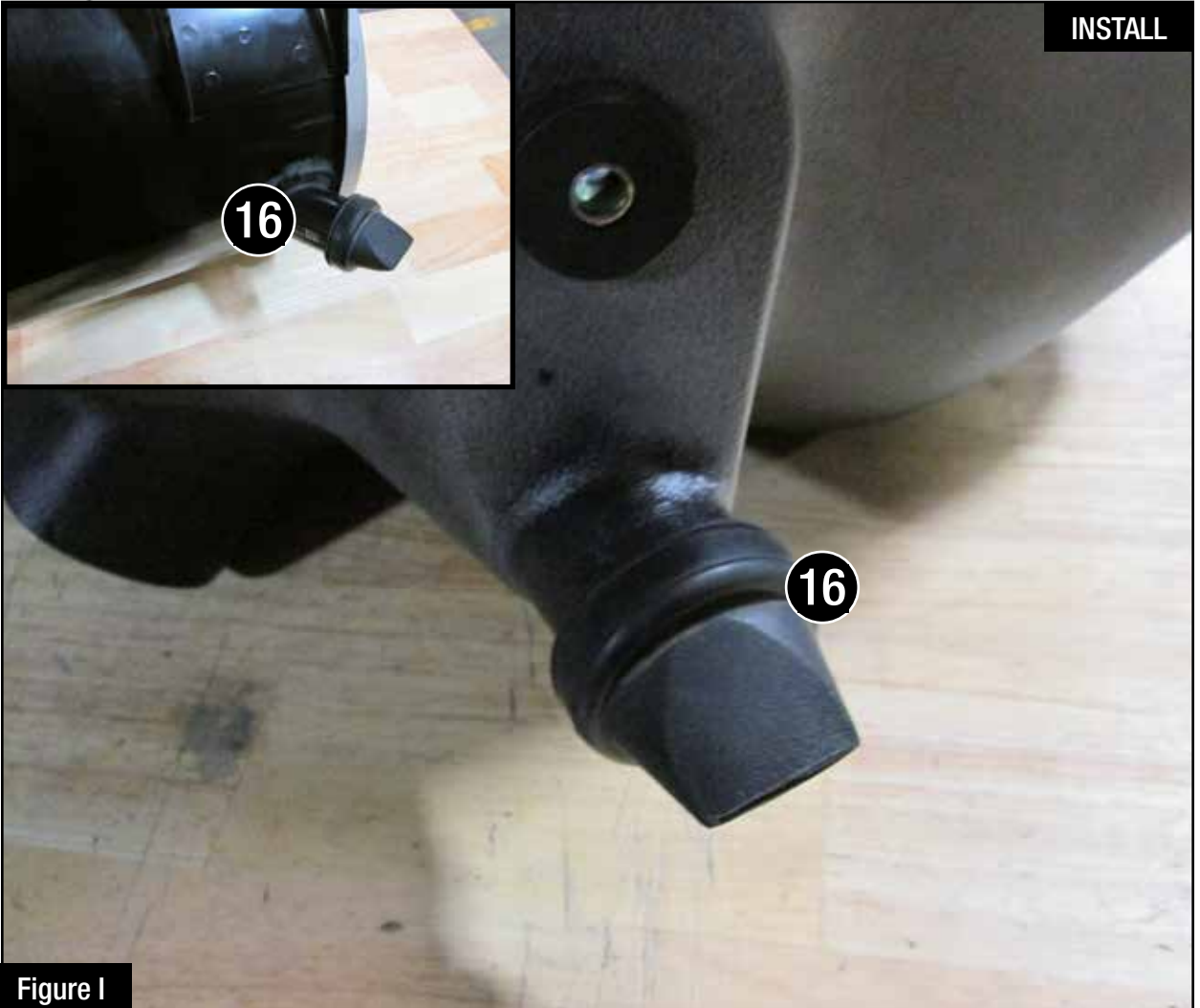

Figure I

Refer to Figure I for Step 9

Step 9: Remove the rubber duckbill valve (16) from the bottom of the air cleaner assembly and install it on the aFe air box.



Figure J

Refer to Figure J for Step 10

Step 10: Stick the supplied foam seal (17) on the air inlet opening of the aFe air box.

**Figure K****Refer to Figure K for Step 11**

Step 11: Using a T-20 driver, remove the mass air flow sensor (18) from the air cleaner assembly and install it on the aFe intake tube with the two supplied screws using a T-25 driver. Do not overtighten.



Figure L

Refer to Figure L for Step 12

Step 12: Using pliers, remove the clamp (19) and the elbow vent fitting (20) from the air intake tube, then install them into the supplied silicone coupler.



Refer to Figure M for Step 13

Step 13: Install the aFe air box into the vehicle by mounting the air inlet to the side wall using a 10mm wrench and the two supplied screws, do not tighten at this time. Next using a 10mm nut driver and three of the mounting bracket screws, align and mount the air box to the frame. Tighten all screws.



Figure N

Refer to Figure N for Step 14

Step 14: Install the supplied large T-bolt clamp over the filter opening on the air box. Slide the aFe filter and clamp into the aFe housing. Do not tighten clamps at this time.

Figure 0

Refer to Figure 0 for Step 15

Step 15: Install the silicone coupler on the throttle body with the supplied clamp (21) as shown. Place the supplied T-bolt clamp (22) on the silicone coupler. Do not tighten the clamps at this time.



Figure P

Refer to Figure P for Step 16

Step 16: Install the aFe intake tube into the vehicle. Slide into the coupler coupler first then into the air filter. Tighten all clamps.

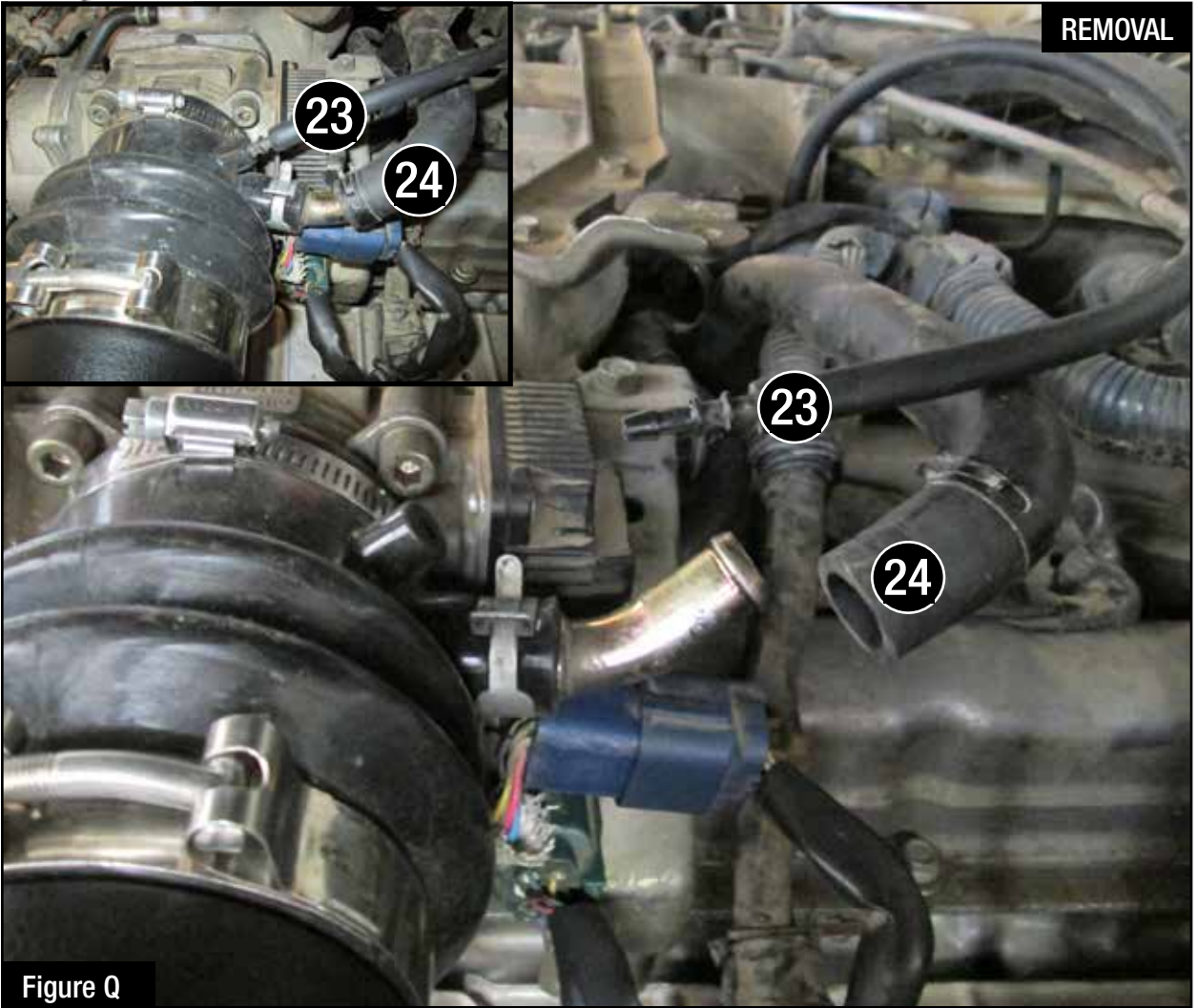

Refer to Figure Q for Step 17

Step 17: Install the supplied vacuum hose connector (23) into the silicone coupler. Install the supplied vacuum hose into the intake solenoid valve and the vacuum hose connector. Install the vent hose (24) to the elbow vent fitting at the coupler.



Figure R

Refer to Figure R for Step 18

Step 18: Re-connect the mass air flow sensor ②5.



Figure S

Refer to Figure S for Step 19

Step 19: Use the provided plug (26) to close additional air inlet if you want to completely seal the air box. Best performance gain is obtained by having more flow (no plug).



Figure T

Refer to Figure T for Step 20

Step 20: Reinstall the engine cover. Check all the components are tight and secure. Your installation is now complete.

Note: Check all bolts, clamps and connectors after 200 miles.



advanced FLOW engineering, inc.

252 Granite Street Corona, CA 92879

<https://afepower.com/contact>