

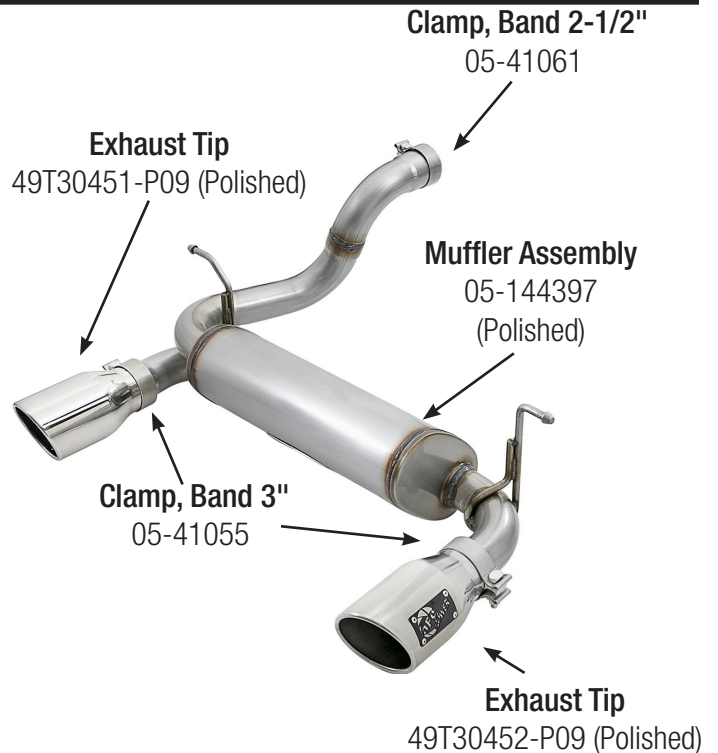

INSTALLATION INSTRUCTIONS

MAKE: Jeep
MODEL: Wrangler (JL)
YEAR: 2018-2022
ENGINE: V8-3.6L / L4-2.0L (t)
FITS: 2 and 4-door

**2-1/2" Stainless Steel
Axle-Back Exhaust
49-48067-B (Black Tips)
49-48067-P (Polished Tips)**

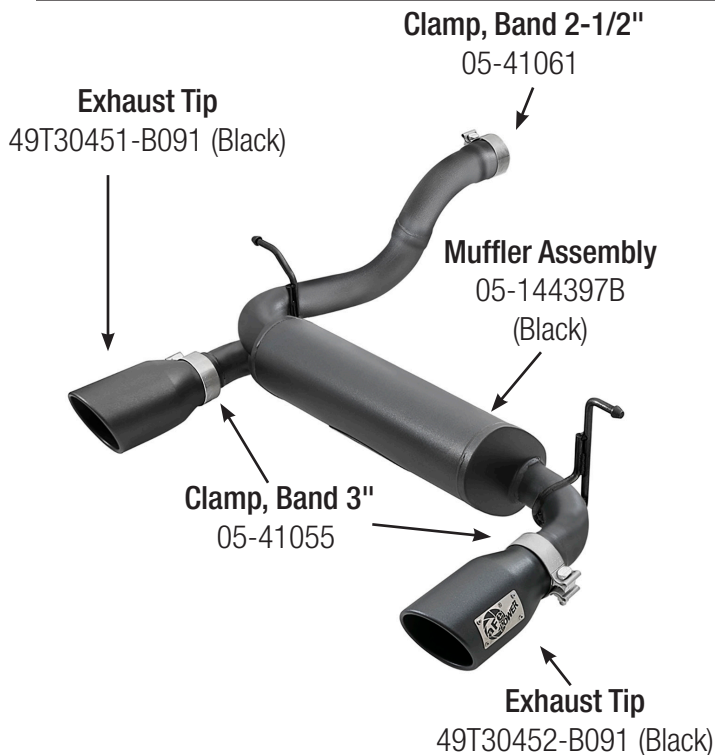

Caution: Allow time for your vehicle to cool down prior to installation. When working on or under your vehicle proceed with caution. Exhaust systems reach high temperatures and may cause serious burns. Wear protective safety equipment; eye goggles and gloves to ensure a safe installation. **aFe recommends professional installation on our products.**

- Step 1.** Read Instructions prior to installation). It may be helpful to lubricate all the factory isolation rubber mounts, before taking off stock exhaust and also before installing aFe exhaust. Always use a jack or stand for support when installing or uninstalling any exhaust system.
- Step 2.** Begin by removing your stock exhaust from the rear of your truck working your way forward. Remove the factory muffler assembly. Take caution not to damage the factory isolation mounts as they will be reused.
- NOTE:** It may be easier to unbolt the muffler hanger brackets from the frame than to disconnect the factory isolatimounts.
- Step 3.** For faster installation spread the pieces of the exhaust alongside of your vehicle, according to the diagram shown. It is recommended to not fully tighten any of the clamps until the entire system has been fully installed.
- Step 4.** Place the provided 2.5" band clamp onto the muffler assembly.
- Step 5.** Install the muffler assembly onto the factory over axle-pipe and slip the hangers into the rubber isolation mounts. Then loosely tighten the band clamp.
- Step 6.** Install the exhaust tips onto the muffler assembly.
- Step 7.** Straighten all exhaust components and begin to tighten down all clamps beginning at the front and ending at the rear.
- Step 8.** Congratulations your exhaust is now complete and ready for daily use! It is recommended to re-tighten all clamps after 50-100 miles. Note: It is normal for the aFe Power Cat-back exhaust to emit smoke for the first few minutes upon

NOTES:

- aFe recommends that the tailpipe be at least 1/2"-1" away from any body panels to avoid heat related body damage. **Tighten and secure.**