

7929 Lincoln Ave. Riverside, CA 92504
Phone: 951.689.ICON | Fax: 951.689.1016

PART #	DESCRIPTION
58671	22-UP TUNDRA 2.5 EXP

COMPONENTS INCLUDED	
(2) 150123 TUNDRA EXP BEAUTY PLATE (2) 154869 22-UP TUNDRA FRONT 2.5 EXP COILOVER	(2) 158011 22-UP TUNDRA EXP COIL SEAT (2) 294060 EXP COIL MOUNT KIT
HARDWARE INCLUDED	
N/A	
TOOLS REQUIRED	
HAMMER TORQUE WRENCH COIL SPRING COMPRESSOR 10MM SOCKET / WRENCH 14MM SOCKET / WRENCH	18MM SOCKET / WRENCH 19MM SOCKET / WRENCH 21MM SOCKET / WRENCH 22MM SOCKET / WRENCH 24MM SOCKET / WRENCH
TECH NOTES	
<p>1. YOUR ICON SHOCK ASSEMBLIES COME FACTORY CHARGED TO 250 PSI. RELEASING NITROGEN PRESSURE MAY LEAD TO SHOCK MALFUNCTION AND REDUCED RIDE QUALITY. FAILURE CAUSED BY LOW NITROGEN PRESSURE IS NOT COVERED UNDER ICON'S WARRANTY POLICY.</p> <p>2. ICON DOES NOT RECOMMEND LIFTING APPROXIMATELY 2.25" OF LIFT WITHOUT AN ICON UPPER CONTROL ARM (PN: 58461DJ OR 58561DJ). FAILURE TO DO SO CAN CAUSE DAMAGE TO AXLES.</p> <p>3. FOR NON TRD MODELS, ICON RECOMMENDS USING ICON DIFF DROP (PN: 55156) OR USING TOYOTA TRD AXLES (PN: 434200C020-DRIVER, PN: 434100C020-PASSENGER). FAILURE TO DO SO COULD RESULT IN AXLE DAMAGE.</p> <p>4. SWAY BAR DROP KIT (PN: 55154) REQUIRED FOR THIS INSTALLATION.</p> <p>5. SEE PAGE 7 FOR EXP SHOCK GROOVE SPECS.</p>	



WARNING!
<p>** READ ALL INSTRUCTIONS THOROUGHLY FROM START TO FINISH BEFORE BEGINNING INSTALLATION! IF THESE INSTRUCTIONS ARE NOT PROPERLY FOLLOWED SEVERE FRAME, SUSPENSION AND TIRE DAMAGE MAY RESULT TO THE VEHICLE!</p> <p>** ICON VEHICLE DYNAMICS RECOMMENDS THAT YOU EXERCISE EXTREME CAUTION WHEN WORKING UNDER A VEHICLE THAT IS SUPPORTED WITH JACK STANDS.</p> <p>** ICON VEHICLE DYNAMICS RECOMMENDS ALL INSTALLATION TO BE PERFORMED BY A PROFESSIONAL SHOP/SERVICE TECHNICIAN. PRODUCT FAILURE CAUSED BY IMPROPER INSTALLATION WILL NOT BE COVERED UNDER ICON'S WARRANTY POLICY.</p>

INSTALLATION

1. Disconnect the ABS line bracket from the UCA using a 10mm. [FIGURE 1]

FIG.1

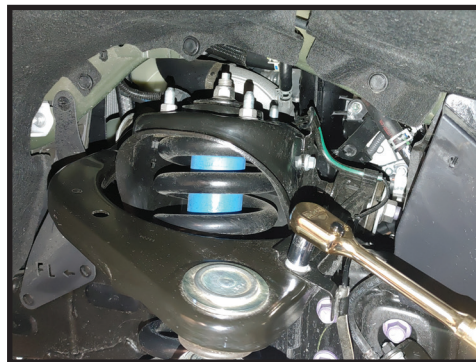

2. Loosen the nut connecting the UCA to the steering knuckle. Separate the UCA taper from the steering knuckle using a hammer or ball joint separator. Keep the nut connected, but loose. This will allow additional freedom of movement for later steps. [FIGURE 2]

FIG.2



3. Remove the sway bar link from the sway bar using a 19mm.

4. Use a 14mm to remove the nuts connecting the factory coil over to the frame. Leave 1 nut loosely threaded on the upper mount. Use a 22mm to disconnect the factory coilover from the LCA. [FIGURE 3 & 4]

FIG.3



FIG.4



5. Support the steering knuckle using a floor jack. [FIGURE 5]

FIG.5



6. Mark the alignment cams on both the cam and the frame. Remove the alignment cam bolts using a 24mm. [FIGURE 6 & 7]

FIG.6



FIG.7



7. Swing the lower control arm out from the frame pockets and let it hang from the steering knuckle.

8. Slowly remove the coilover assembly from the truck.

9. Grind/cut the lower shock pocket on the control arm to add clearance for the new ICON coilover assembly. Removing the control arm can help make this easier, if removed, be sure the bolts go back into the same place and orientation. After cutting is complete, paint over the raw metal to prevent rust. [FIGURE 8 & 9]

FIG.8

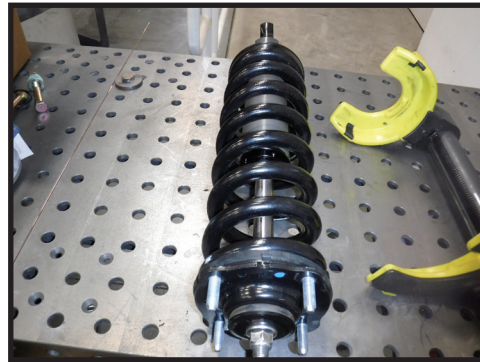

FIG.9



10. Mark the upper mount of the shock assembly in line with the rod end of the shock. This will be referenced when putting it back together. [FIGURE 10]

FIG.10



11. Use a sturdy coil spring compressor to compress the coil spring of the factory coilover assembly. Once the coil is free from its seats, remove the shaft nut and upper coil seat/upper mount. [FIGURE 11 & 12]

FIG.11



FIG.12

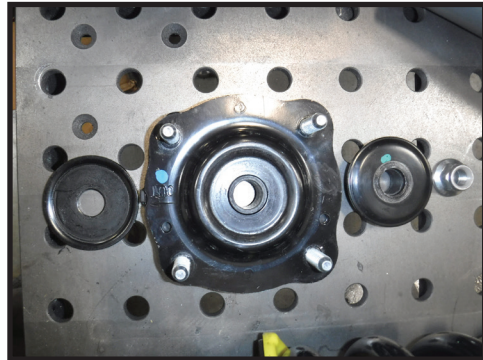

12. Slide the snap ring to the desired lift height and set the coil seat in place. [FIGURE 13, 14, 15, 16]

FIG.13

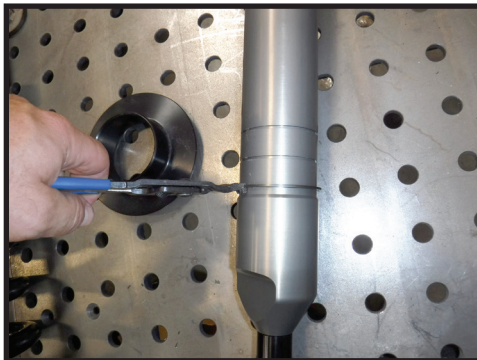

FIG.14

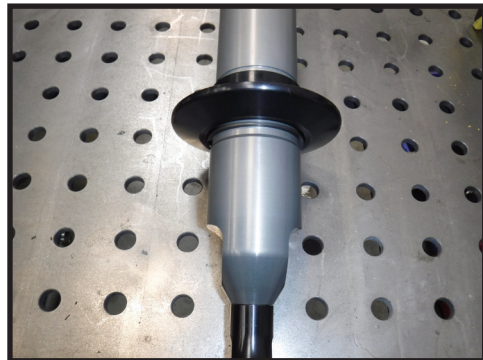

FIG.15

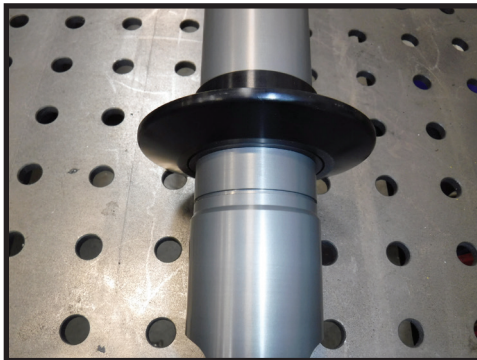
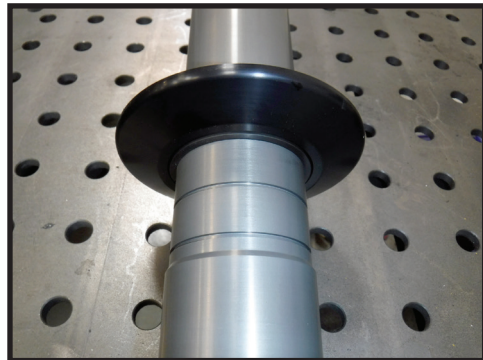

FIG.16



13. Carefully remove the shock assembly from the coil. Slide the new EXP shock assembly into place. Install the upper coil seat/upper mount and factory nut. Torque to factory spec using an 18mm. Be sure to clock the upper and lower coil seats to match the coil ends. The mark on the upper mount needs to line up with the line on the shock. [FIGURE 17 & 18]

FIG.17

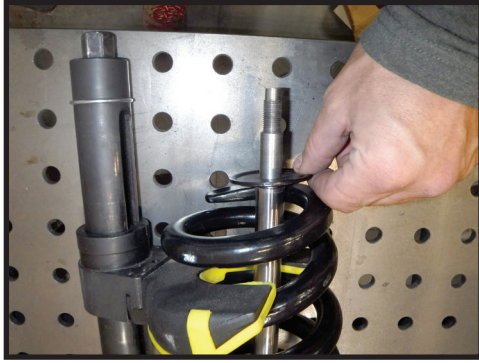
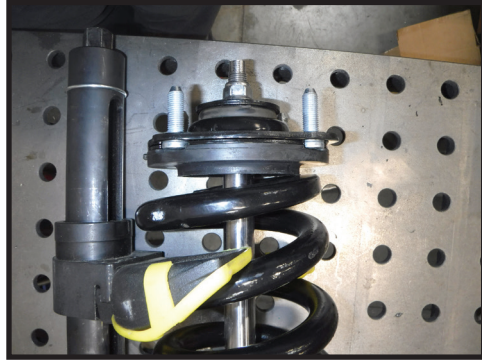

FIG.18



14. Release the coil spring compressor while ensuring proper alignment of you mark with the rod end.

15. The "OUT" arrow should be pointing 180 degrees away from the charge port of the shock. [FIGURE 19]

FIG.19



16. Place the supplied beauty plate (PN 150123) over the studs of the upper mount (optional).

17. Lift the coilover assembly up into the frame mount and fasten using the factory nuts. Torque to factory spec using a 14mm.

18. Lift the lower control arm into the frame pockets while guiding the coilover into the shock mount. Put the cam bolts in the same place and orientation as they came out. Adjust the cam bolts of the lower arms to line up the marks. Torque the bolts to factory spec using a 24mm. [FIGURE 20 & 21]

FIG.20



FIG.21



19. Install the lower shock bolt and torque to factory spec using a 22mm. [FIGURE 22]

FIG.22



20. Connect the ABS bracket to the UCA using a 10mm. [Torque to factory spec]

21. Connect the UCA to the steering knuckle using factory hardware and torque to factory spec using a 21mm.

22. When lifting above 2.25" install (PN: 55154, sold separately). Remove the sway bar mounting bracket from the frame using a 17mm and install the new drop spacers between the bracket and frame. Reinstall with the new bolts and torque to factory spec. [FIGURE 23 & 24]

FIG.23



FIG.24



23. Install the wheels and set the truck on the ground. Have the truck professionally aligned.



VERIFY ALL FASTENERS ARE PROPERLY TORQUED BEFORE DRIVING VEHICLE.

RETORQUE ALL NUTS, BOLTS AND LUGS AFTER 100 MILES AND PERIODICALLY THEREAFTER.

2.5 VS SERIES SHOCK & COILOVER TECHNICAL INFORMATION

MAINTENANCE

ICON shock absorbers are a high quality rebuildable race style shock absorber designed for optimal performance. With a unit of this caliber on your vehicle, routine maintenance is required to keep them looking and operating in like new condition. Residual oil and assembly lube may be present at all seal paths from the factory out of the box and is considered normal. Pooling of oil however is not acceptable at any time and one should contact the ICON dealer where purchased.

BELOW ARE GUIDELINES BASED ON HOW YOU USE YOUR VEHICLE BUT YOUR MILEAGE MAY VARY:

STREET USE:

- Send in for factory servicing every 40,000 miles or if a leak develops, ride quality decreases, or they begin to make excessive noise.
- Remove any buildup of road salt, mud, or debris from shocks and coil springs anytime accrued
- Clean with mild soap and water with each oil change or anytime you notice build up.
- Wax the cylinders yearly with automotive wax to prevent corrosion.
- Check nitrogen pressure yearly. (252004 charge needle assembly available at any ICON distributor)
- Check bearings for excessive wear yearly.
- DO NOT apply any type of lube to the upper and lower bearings.

STREET/DIRT:

- Send in for factory servicing every 15,000 miles or if a leak develops, ride quality decreases, or they begin to make excessive noise.
- Clean with mild soap and water with each oil change, offroad trip, or anytime you notice build up.
- Wax the cylinders yearly with automotive wax to prevent corrosion.
- Check nitrogen pressure each dirt outing. (252004 charge needle assembly available at any ICON distributor)
- Check bearings for excessive wear yearly.
- DO NOT apply any type of lube to the upper and lower bearings.

DIRT USE:

- Send in for factory servicing every 1,000 miles.
- Check nitrogen pressure each outing. (252004 charge needle assembly available at any ICON distributor)
- Remove any buildup of mud or debris from shocks and coil springs after every outing.

SELF-SERVICE:

- Contact ICON for service kits & tools at (951) 689-4266.

PRODUCT REGISTRATION

Please visit: <http://www.iconvehicledynamics.com/tech-support/registration/> to register your product.

ICON VEHICLE DYNAMICS SHOCK ABSORBER WARRANTY

This shock absorber has a 1 year warranty against any manufacturer's defects. If a shock fails within the initial year of ownership, the shock must be shipped to ICON Vehicle Dynamics for inspection and service. If a shock is inspected and it has been determined the shock failed due to neglect, damage caused by improper installation or any other reason besides "normal wear and tear", the owner of said shock is responsible for all service costs. This includes labor, parts, and shipping.

ICON Vehicle Dynamics warrants to the original retail purchaser who owns the vehicle on which the product was originally installed. ICON Vehicle Dynamics does not warrant the product for finish, alterations, modifications and/or installation contrary to ICON Vehicle Dynamics instructions. ICON Vehicle Dynamics products are not designed, nor are they intended to be installed on vehicles used in race applications, for racing purposes or for similar activities. (A "race" is defined as any contest between two or more vehicles, or a contest of one or more vehicles against the clock, whether or not such contest is for a prize). This warranty does not include coverage for police or taxi vehicles, race vehicles, or vehicles used for government or commercial purposes. Also excluded from this warranty are sales outside of the United States of America and Canada.

ICON Vehicle Dynamics' obligation under this warranty is limited to the repair or replacement, at ICON Vehicle Dynamics' discretion, of the defective product. Any and all costs of removal, installation or re-installation, freight charges and incidental or consequential damages are expressly excluded from this warranty. Items that are subject to wear are not considered defective when worn and are not covered.

ICON Vehicle Dynamics components must be installed as a complete kit as shown in our current application guide. Any substitutions or exemptions of required components will immediately void the warranty. Some finish damage may happen to parts during shipping and is not covered under warranty.

This warranty is expressly in lieu of all other warranties expressed or implied. This warranty shall not apply to any product that has been improperly installed, modified or customized subject to accident, negligence, abuse or misuse.

To send a shock in for warranty please visit our website <http://www.iconvehicledynamics.com/tech-support/shock-service/>



ICON VEHICLE DYNAMICS®
PERFORMANCE SUSPENSION SYSTEMS AND SHOCK ABSORBERS

7929 Lincoln Ave. Riverside, CA 92504 Phone: 951.689.ICON Fax: 951.689.1016
www.iconvehicledynamics.com



FOLLOW US ON FACEBOOK!



ICON TUNDRA FRONT EXP GROOVE SPECS

FENDER TO HUB MEASUREMENT

FACTORY
RIDE HEIGHT: 21.5"

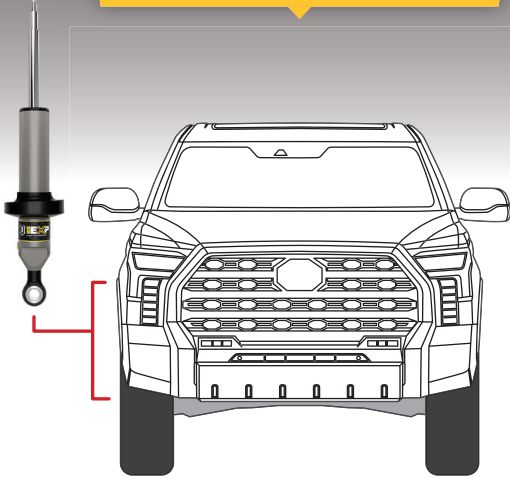

MAXIMUM
RIDE HEIGHT: 24.5"

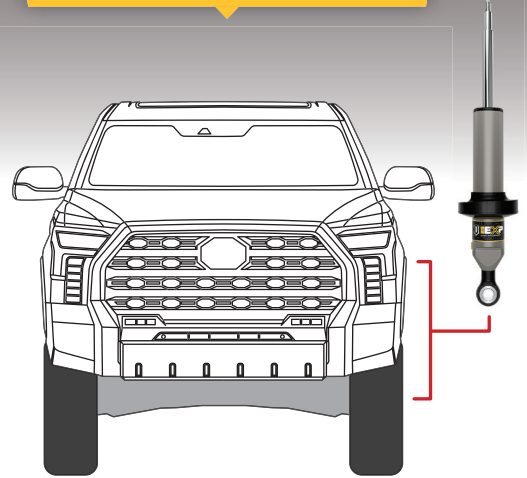

GROOVE 1:

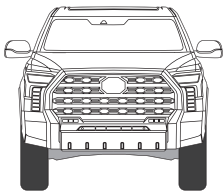

Stock Height

GROOVE 2:

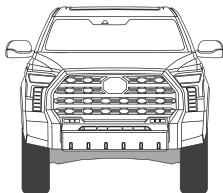

2.25" LIFT

GROOVE 3:

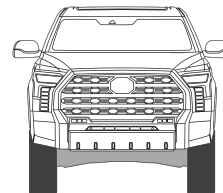

2.5" LIFT

GROOVE 4:

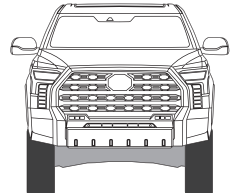

3" LIFT

GROOVE 1 & 2

IF YOU USE ANY OTHER GROOVE, THE FACTORY SPRING CAN BE DAMAGED.

GROOVE 3 & 4

IF YOU USE ANY OTHER GROOVE, THE FACTORY SPRING CAN BE DAMAGED.

