



**DIRECT-REPLACEMENT  
INSTALLATION GUIDE**

**FORD BRONCO (2021-ON)**

---

# **PERFORMANCE ELITE SERIES 2.5 DUAL SPEED COMPRESSION**

---

883-06-192 - Kit: 21-ON Ford Bronco, w/ UCA, 2 Door, Front Coilover, 2.5 Truck PES, R/R, Base 3.5-4.5" Lift, Sasquatch 2.5-3.5" Lift, DSC

883-06-193 - Kit: 21-ON Ford Bronco, 2 Door, Rear, Coilover, 2.5 Truck PES, R/R, Base 3.5-4.5" Lift, Sasquatch 2.5-3.5", DSC

883-06-195 - Kit: 21-ON Ford Bronco, w/ UCA, 4 Door, Front Coilover, 2.5 Truck PES, R/R, 2-4" Lift, DSC

883-06-196 - Kit: 21-ON Ford Bronco, 4 Door, Front Coilover, 2.5 Truck PES, R/R, 2-4" Lift, DSC

# CONTENTS

---

<b>INTRODUCTION</b>	<b>1</b>
<b>SUPPLIED PARTS</b>	<b>2</b>
<b>SHOCK DIAGRAM</b>	<b>3</b>
<b>SAFETY INSTRUCTIONS</b>	<b>4</b>
<b>INSTALLATION GUIDELINES</b>	<b>5</b>
<b>FRONT SHOCK INSTALLATION</b>	<b>6</b>
<b>REAR SHOCK INSTALLATION</b>	<b>12</b>
<b>FOX FACTORY DSC</b>	<b>17</b>
<b>WARRANTY INFORMATION</b>	<b>18</b>
<b>SHOCKS NEED LOVE TOO</b>	<b>19</b>

# INTRODUCTION

---

Thank you for choosing FOX direct-replacement shocks for your vehicle. FOX products are designed, tested, and manufactured by the finest professionals in the industry.

FOX recommends that you become completely familiar with the handling characteristics of your modified vehicle before operating it under rigorous conditions, helping to avoid potential rollover situations and other loss of control events. FOX further recommends that you use appropriate protective equipment at all times when operating your vehicle.

To achieve the best performance and product longevity, periodic service and maintenance is required. Please refer to the Service and Upgrades section for more information.

## IN THE BOX

- Reservoir Mounts
- Front or Rear Shocks
- Supplied Hardware
- Installation Guide

# SUPPLIED PARTS

SHOCK ASSEMBLY				
FOX PN	DESCRIPTION		QTY	NOTES
983-06-192-L/R	FRONT, LEFT/RIGHT COIL-OVER		2	2 Door
983-06-193	REAR, LEFT COIL-OVER		1	2 Door
983-06-194	REAR, RIGHT COIL-OVER		1	2 Door
983-06-195-L/R	FRONT, LEFT/RIGHT COIL-OVER		2	4 Door
983-06-196	REAR, LEFT COIL-OVER		1	4 Door
983-06-197	REAR, RIGHT COIL-OVER		1	4 Door
FRONT RESERVOIR BRACKET ASSEMBLY				
FOX PN	DESCRIPTION	*HARDWARE REF.	QTY	NOTES
026-01-231-1	FRONT LEFT RESERVOIR BRACKET	B1	1	Brackets mount the remote reservoirs to the vehicle.
026-01-231-2	FRONT RIGHT RESERVOIR BRACKET	B2	1	
019-01-040	BOLT: M8, 1.25"	C1	1	Mounts the right reservoir bracket.
018-01-066	SCREW: 8-32, 3/4"	D1	8	Each bracket uses two clamps and a clamp uses two screws.
026-01-167-1	2.5 RESERVOIR CLAMP, TOP	D2	4	
026-01-167-2	2.5 RESERVOIR CLAMP, BOTTOM	D3	4	
REAR RESERVOIR BRACKET ASSEMBLY				
FOX PN	DESCRIPTION	*HARDWARE REF.	QTY	NOTES
026-01-223	BACKING PLATE	E1	2	Each backing plate uses two speed nuts. Two hex bolts mount a reservoir bracket to a backing plate.
018-00-065	SPEED NUT: 5/16-18	E2	4	
018-04-043	BUTTON HEAD SCREW: 5/16-18, 1"	E3	4	
026-01-222-1	REAR LEFT RESERVOIR BRACKET	F1	1	Brackets mount the remote reservoirs to the vehicle.
026-01-222-2	REAR RIGHT RESERVOIR BRACKET	F2	1	
018-01-066	SCREW: 8-32, 3/4"	G1	8	Each bracket uses two clamps and a clamp uses two screws.
026-01-167-1	2.5 RESERVOIR CLAMP, TOP	G2	4	
026-01-167-2	2.5 RESERVOIR CLAMP, BOTTOM	G3	4	

\*Hardware Reference is used throughout the installation manual to provide notation of the supplied kit.



# SHOCK DIAGRAM

## FRONT COIL-OVER

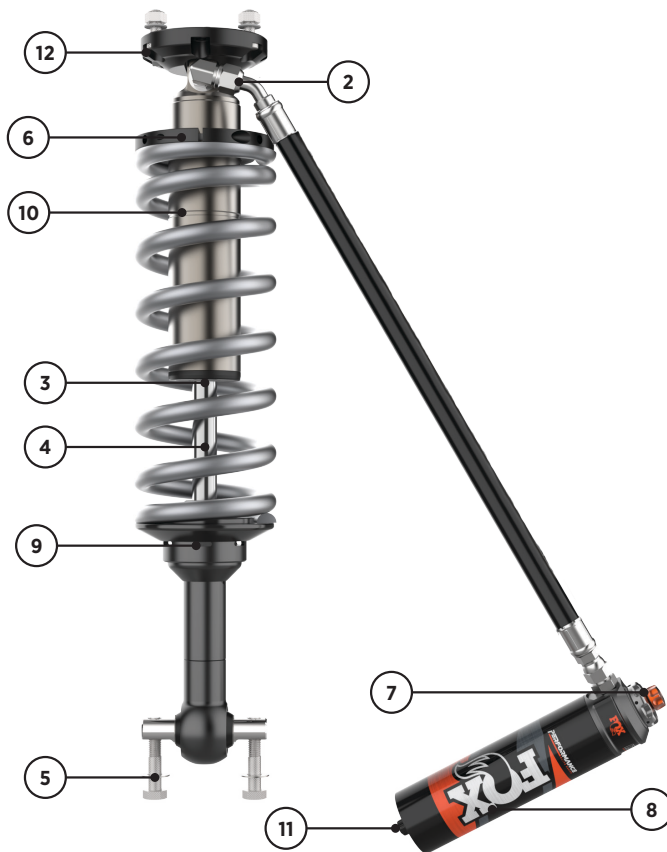

## REAR COIL-OVER

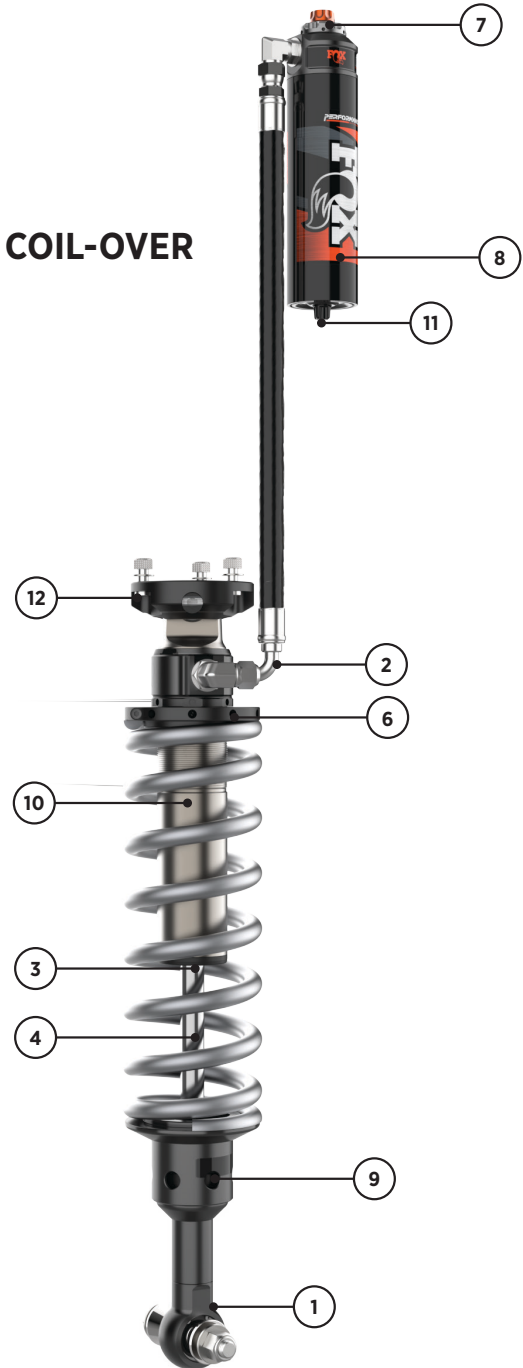

PART NO.	NAME	PART NO.	NAME
1	Eyelet	7	DSC Adjusters
2	Hose Fitting	8	Reservoir
3	Wiper seal	9	Bumper
4	Shaft	10	Shock body
5	Bar-pin bolt	11	Schrader valve
6	Preload ring	12	Top hat

## WARNING

# SAFETY INSTRUCTIONS

---

- FOX direct-replacement shocks are designed to fit and allow proper clearance with the stock suspension. If aftermarket suspension components are installed it is the customer's responsibility to ensure that interference between the FOX shocks and other vehicle components does not occur at any point in the shock stroke.
- FOX direct-replacement shocks should always be installed as a set for maximum performance.
- Proper installation and service procedures are essential for the safe and reliable operation of the suspension components, requiring the experience and tools specially designed for this purpose. Installation and maintenance procedures for this product must be performed by a qualified service technician, to avoid potentially unsafe vehicle handling characteristics, which may result in **SERIOUS INJURY** or **DEATH**.
- Modifying your vehicle's suspension will change the handling characteristics of your vehicle. Under certain conditions, your modified vehicle may be more susceptible to loss of control or rollover, which can result in **SERIOUS INJURY** or **DEATH**. Thoroughly familiarize yourself with the modified vehicle handling characteristics before any rigorous vehicle operation. Wear protective body gear and a helmet when appropriate. Installation of vehicle roll bars or cage is highly recommended.
- FOX direct-replacement shocks are gas-charged and are highly pressurized. Placing shocks in a vise or clamp, applying heat, or attempting to open or service the shock without the proper tools and training can result in **SERIOUS INJURY** or **DEATH**. Do not attempt to modify, puncture or incinerate a FOX direct-replacement shock absorber.
- Any attempt to misuse, misapply, modify, or tamper with any FOX product voids any warranty and may result in **SERIOUS INJURY** or **DEATH**.

## WARNING

# INSTALLATION GUIDELINES

---

- Always use a chassis lift for the installation of shocks, and make certain that the raised vehicle is securely attached to the lift to prevent the vehicle from slipping, falling, or moving during the installation process.
- DO NOT install any FOX product without the necessary special tools, expertise and chassis lift or you will subject yourself to the risk of SERIOUS INJURY or DEATH. If you elect to not use a chassis lift (which may result in SERIOUS INJURY or DEATH), ensure that the vehicle is: (1) on level ground, (2) that all tires on the ground during installation are blocked to prevent vehicle movement, (3) that at least two tires are on the ground at all times, and (4) that adequately secured jack stands are used to support the vehicle. NEVER get under the vehicle until you have checked to ensure that the vehicle will be stable during installation.
- FOX direct-replacement shocks are designed to fit your vehicle's shock mounts without modification except the reservoir placement on specific models and applications.
- If a preload adjustment is necessary for your application DO NOT adjust preload with the coil-over on the vehicle. Remove the coil-over from the vehicle and use a spring compressor to remove the lower spring hardware and spring. Once the spring is removed, you can adjust the preload ring. DO NOT Exceed more the 1/2" of additional preload. If more than 1/2" of preload is required, you will need to go up in spring rate or get a longer spring that fits the application.

# FRONT SHOCK INSTALLATION

**NOTICE:** Medium-strength thread-lock is recommended on all bolts.

1. Please read the installation guidelines on page 5 for instructions on how to properly lift and secure the vehicle.
2. Record the front vehicle ride height to ensure proper lift is attained after kit is installed. READ INSTALLATION GUIDELINES ON HOW TO PROPERLY ADJUST PRELOAD.
3. Remove both front wheels from the vehicle.
4. Pull the fender liner from the wheel well (Fig. 1).



Fig. 1: Pull the fender liner.

## RESERVOIR BRACKET INSTALLATION

5. Remove the bolts that fasten the brake bracket to the vehicles frame (Fig. 2).
6. Mount the reservoir bracket over the brake bracket. The passenger side requires the provided bolt (C1) in addition to the OEM bolt (Fig. 3). Torque to OEM specification.

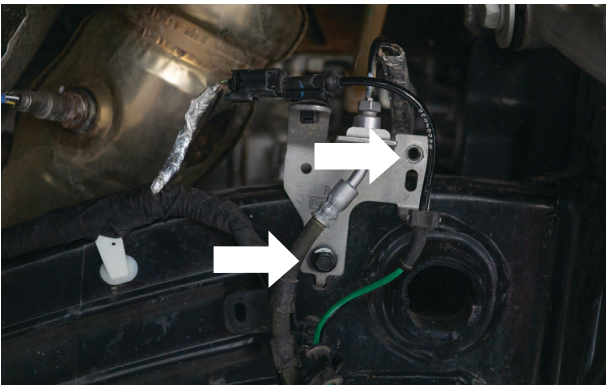

Fig. 2: Remove the brake line bracket bolts.

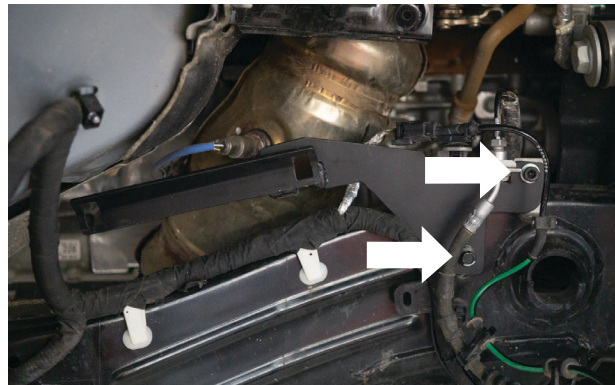

Fig. 3: Mount the reservoir bracket.

## STOCK SHOCK REMOVAL

7. Disconnect the brake line bracket from the upright (Fig. 4).



Fig. 4: Disconnect brake line bracket.

8. Detach the tie rod end link at the spindle steering arm for removal and installation clearance (Fig. 5).

9. Disconnect the sway bar end link from both lower control arms (Fig. 6).

10. Remove the axle nut from the upright (Fig. 7). Push the axle shank flush with the face of the rotor.

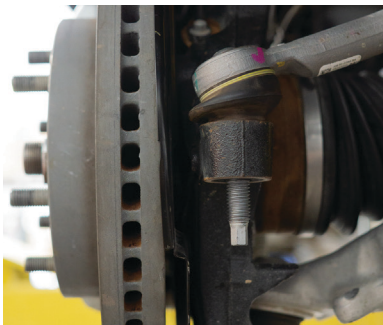

Fig. 5: Tie rod end link.



Fig. 6: Sway bar end link.



Fig. 7: Push the axel shank flush.

11. Remove the nut connecting the upper control arm (UCA) to the upright (Fig. 8) Separate the UCA from the upright.



Fig. 8: Separate the UCA from the upright.



12. Remove the three top hat nuts that secure the stock coil-over assembly (Fig. 9). DO NOT remove the center nut. Removal of the center nut will release the spring from the shock assembly and may result in **SERIOUS INJURY** or **DEATH!**

13. Use a pry bar to free the top of the coil-over from the coil bucket (Fig. 10).



Fig. 9: DO NOT remove the center nut.



Fig. 10: Free the coil-over from the coil bucket.

14. Take off the bar-pin bolts connecting the coil-over to the lower control arm (Fig. 11). Remove the stock coil-over assembly (Fig. 12).



Fig. 11: Take off the bar-pin bolts.

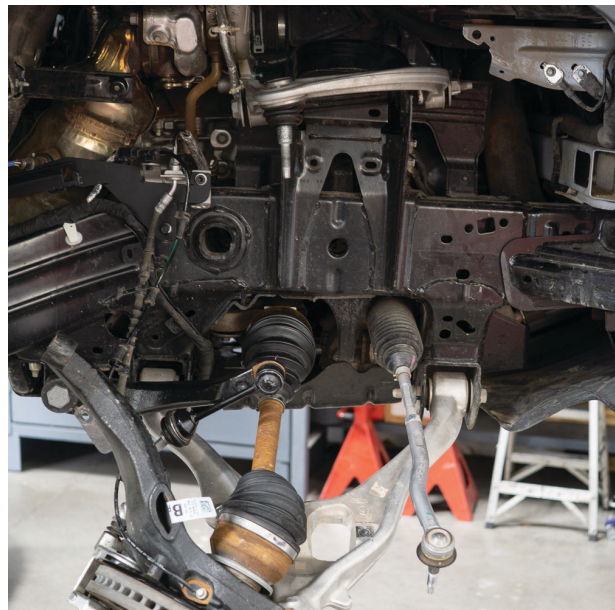

Fig. 12: Free the coil-over from the coil bucket.

**NOTICE:** Do not discard the OEM hardware. They will be used with your new FOX coil-over assembly.

15. If you're installing an aftermarket UCA, install now and follow the company's required specifications. After installation, continue to step 16.

### FOX COIL-OVER INSTALL

16. Install the new coil-over assembly with the hose fitting facing outboard and the reservoir pointed toward the rear of the vehicle (Fig. 13).

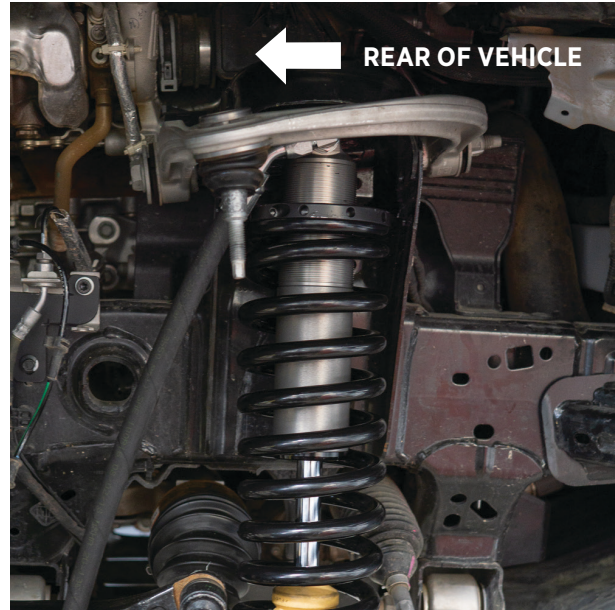

Fig. 13: Install the FOX coil-over.

17. Mount the three supplied top hat nuts and torque to 24 ft-lbs. (Fig. 14).

18. Fasten the two supplied bar-pin bolts to the lower shock mount and torque to 50 ft-lbs. (Fig. 15).



Fig. 14: Mount the top hat nuts.



Fig. 15: Fasten the bar-pin bolts.



19. Mount the reservoir to the mounting bracket with the supplied reservoir clamps (D1-3). Utilize the slots in the bracket to locate the clamps. Do not feed the clamps through the slots in the bracket (Fig. 16a). Once installed, the reservoir should mount flush with the mounting bracket (Fig. 16b).

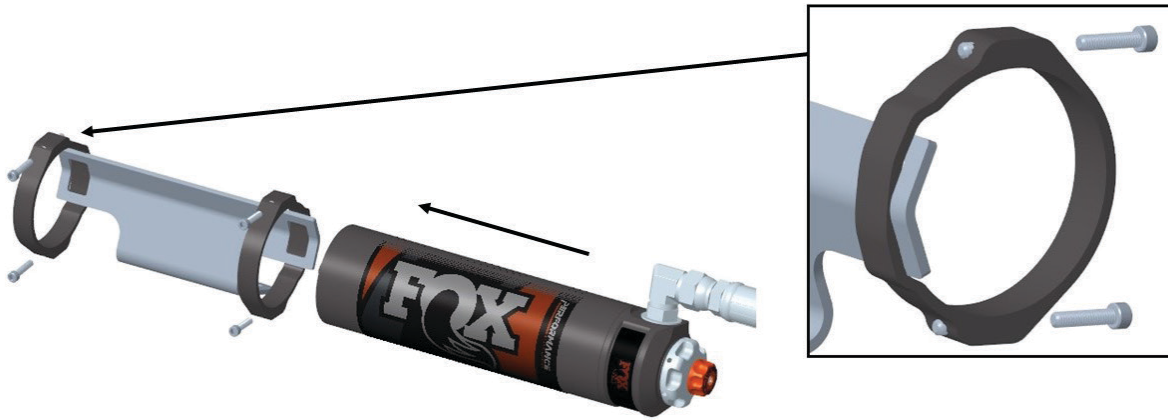

Fig. 16a: Diagram of reservoir and bracket interface.



Fig. 16b: Mounted reservoir.

20. Reattach the UCA to the upright with the ball joint bolt. Support the axle during the reinstallation. Fasten the nut to both the axle nut and UCA. Torque the nuts to OEM specification (Fig. 17 & 18).

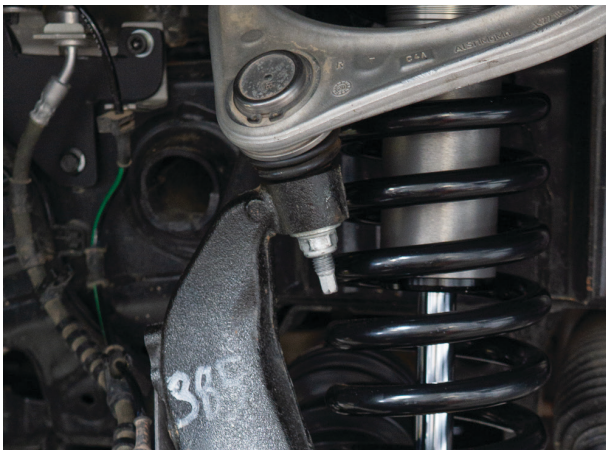

Fig. 17: Reattach the UCA.



Fig. 18: Fasten the axle nut.



21. Reinstall the tie rod end (Fig. 19), sway bar end link (Fig. 20), and brake bracket bolt (Fig. 21). Torque all hardware to OEM specification.



Fig. 19: Tie rod end.



Fig. 20: Sway bar end link.



Fig. 21: Brake bracket bolt.

## FENDER LINER TRIMMING

**NOTICE:** Fender liner trimming is optional. The DSC adjusters are still serviceable if uncut fender liners are reinstalled.

22. Test fit the fender liner and assess how much trimming is required. Draw a cut line on the fender liner (Fig. 22).

23. Remove the fender liner and begin with a conservative cut. Repeat test fitting and cutting until you've achieved the desired appearance (Fig. 23).



Fig. 22: Test fit the fender liner.



Fig. 23: Cut fender liner.

# REAR SHOCK INSTALLATION

**NOTICE:** Medium-strength thread-lock is recommended on all bolts.

1. Please read the installation guidelines on page 5 for instructions on how to properly lift and secure the vehicle.
2. Remove both rear wheels.
3. Pull the inner fender liner from the wheel well (Fig. 24).
4. Support the center of the differential with a jack stand (Fig. 25).



Fig. 24: Pull the fender liner.

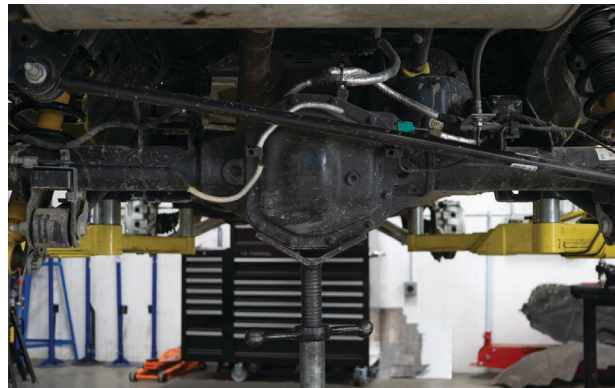

Fig. 25: Support the differential.

## STOCK SHOCK REMOVAL

5. Loosen the coil-over's lower mounting bolt and three top hat nuts (Fig. 26 & 27). **DO NOT** remove the center nut. Removal of the center nut will release the spring from the stock assembly and may result in **SERIOUS INJURY** or **DEATH**!



Fig. 26: Loosen the lower mounting bolt.



Fig. 27: Do not remove the center nut.





Fig. 28: Remove the stock coil-over.

6. Remove the top hat nuts first, then the lower shock mount bolt. Slide the stock coil-over out (Fig. 28).

### RESERVOIR BRACKET INSTALLATION

7. Mate the backing plate and speed nuts (E1-2) (Fig. 29). The speed nuts concentrically align with the backing plate's holes. If the speed nuts are too loose, compress them with pliers.

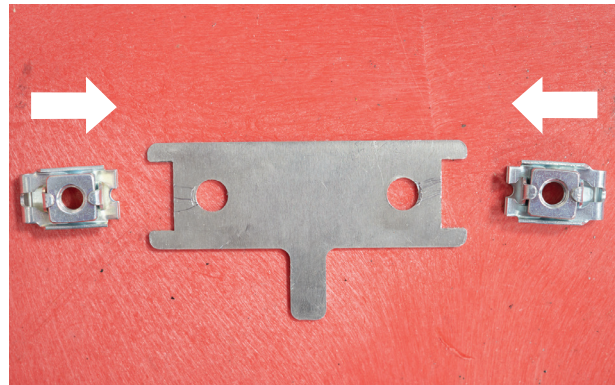

Fig. 29: Mate the backing plate and speed nuts.

8. Align the backing plate with the two holes on the frame of the vehicle (Fig. 30).

9. Mount the reservoir bracket to the vehicle with the supplied button head screws (E3) and torque to 20 ft-lbs. (Fig. 31).



Fig. 30: Align backing plate with the frame.



Fig. 31: Mount the reservoir bracket.

## FOX SHOCK INSTALLATION

10. Orient the FOX coil-over. The hose fitting faces outboard and the reservoir mounts toward the front of the vehicle (Fig. 32).

11. Attach the top hat nuts. (Fig. 33).

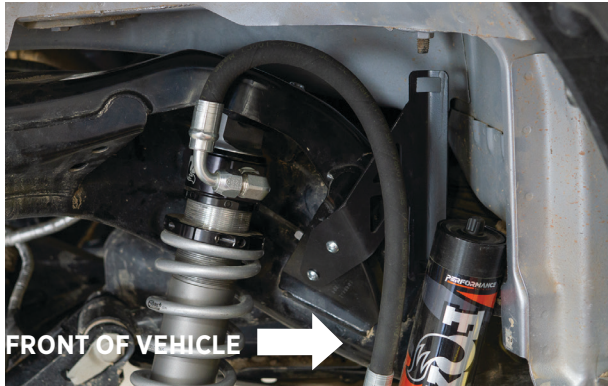

Fig. 32: Face the hose fitting outboard.



Fig. 33: Attach the top hat nuts.

12. Droop out the axle to install the lower shock bolt. The lower bolt uses two adaptors on both sides of the shock mount. The adaptor reduces the holes from 20mm to 5/8". Next, install the two spacers that interface with the shock's eyelet. The larger spacer mounts on the inboard side of the eyelet (Fig. 34b). Torque to 160 ft-lbs.



Fig. 34a: Install the adaptors on both sides of the shock mount.

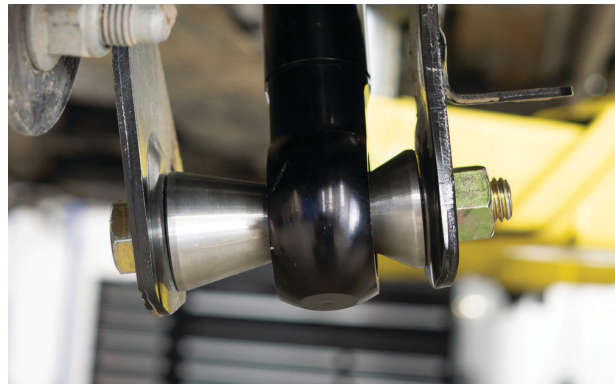

Fig. 34b: The larger spacer is mounted on the inboard side of the eyelet.



13. Fasten the reservoir to the mounting bracket with the DSC adjuster pointed downward, using the provided reservoir clamps (G1-3). Utilize the slots in the bracket to locate the clamps. Do not feed the clamps through the slots in the bracket (Fig. 16a - page 10). Once installed, the reservoir mounts flush to the bracket (Fig. 35).



Fig. 34: Mount the reservoir to the mounting bracket.

### FENDER LINER TRIMMING

**NOTICE:** Fender liner trimming is optional. The DSC adjusters are still serviceable if uncut fender liners are reinstalled.

14. Test fit the fender liner and assess how much trimming is required. Draw a cut line on the fender liner (Fig. 36).



Fig. 36: Test fit the fender liner.

15. Remove the fender liner and begin with a conservative cut. Repeat test fitting and cutting until you've achieved the desired appearance (Fig. 37).



Fig. 37: Cut fender liner.

### FINAL CHECK AND DETAILS

16. Check that the suspension has proper clearance.

17. Reinstall the wheels and torque to OEM specifications.

18. Set the vehicle back on the ground and drive back and forth several feet to allow the suspension to settle. Now measure ride height and adjust if necessary. READ INSTALLATION GUIDELINES ON HOW TO PROPERLY ADJUST PRELOAD.

19. It is highly recommended that you have your wheel alignment checked.

# FOX FACTORY DSC

## DUAL SPEED COMPRESSION (DSC) ADJUSTER SETTINGS

### DSC HIGH SPEED COMPRESSION

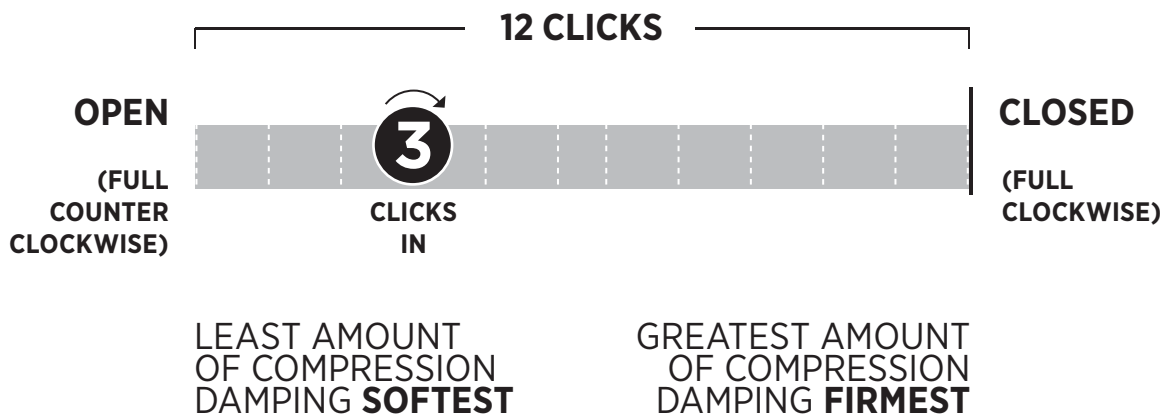

### DSC LOW SPEED COMPRESSION

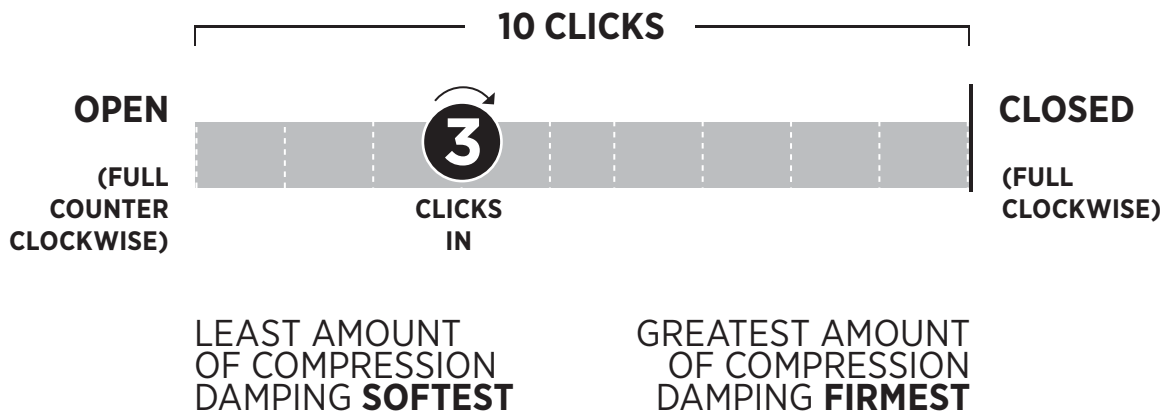

# WARRANTY INFORMATION

## FOX LIMITED WARRANTY

FOX Factory, Inc., a Georgia corporation having an office at 6634 Highway 53 Braselton, GA 30517 (“FOX”), makes the following LIMITED WARRANTY with respect to its suspension products:  
LIMITED ONE (1) YEAR WARRANTY ON SUSPENSION PRODUCTS.

Subject to the limitations, terms and conditions hereof, FOX warrants, to the original retail owner of each new FOX suspension product, that the FOX suspension product, when new, is free from defects in materials and workmanship. Unless otherwise required by law, this warranty expires one (1) year from the date of the original FOX suspension product retail purchase from an authorized FOX dealer or from a FOX authorized Original Equipment Manufacturer where FOX suspension is included as original equipment on a purchased vehicle. If law requires a warranty duration of greater than one (1) year, then, subject to the other provisions hereof, this warranty will expire at the end of the minimum warranty period required by such law.

## TERMS OF WARRANTY

This warranty is conditioned on the FOX suspension product being operated under normal conditions and properly maintained as specified by FOX. This warranty is only applicable to FOX suspensions purchased new from an authorized FOX source and is made only to the original retail owner of the new FOX suspension product and is not transferable to subsequent owners. This warranty is void if the FOX suspension product is subjected to abuse, neglect, improper or unauthorized repair, improper or unauthorized service or maintenance, alteration, modification, accident or other abnormal, excessive, or improper use.

Should it be determined by FOX in its sole and final discretion, that a FOX suspension product is covered by this warranty, it will be repaired or replaced, by a comparable model, at FOX’s sole option, which will be conclusive and binding. THIS IS THE EXCLUSIVE REMEDY UNDER THIS WARRANTY. ANY AND ALL OTHER REMEDIES AND DAMAGES THAT MAY OTHERWISE BE APPLICABLE ARE EXCLUDED, INCLUDING, BUT NOT LIMITED TO, INCIDENTAL OR CONSEQUENTIAL DAMAGES OR PUNITIVE DAMAGES.

This limited warranty does not apply to normal wear and tear, malfunctions or failures that result from abuse, improper assembly, neglect, alteration, improper maintenance, crash, misuse or collision. This limited warranty gives the consumer specific legal rights. The consumer may also have other legal rights which vary from state to state or country to country. Some states and countries do not allow the exclusion or limitation of incidental or consequential damages or warranties, and if dictated by law the above limitations or exclusions may not apply to you. If it is determined by a court of competent jurisdiction that a certain provision of this limited warranty does not apply, such determination shall not affect any other provision of this limited warranty and all other provisions shall remain in full effect.

THIS IS THE ONLY WARRANTY MADE BY FOX ON ITS SUSPENSION PRODUCTS AND COMPONENTS, AND THERE ARE NO WARRANTIES WHICH EXTEND BEYOND THE DESCRIPTION HEREIN. ANY WARRANTIES THAT MAY OTHERWISE BE IMPLIED BY LAW INCLUDING, BUT NOT LIMITED TO, ANY IMPLIED WARRANTY OF MERCHANTABILITY OR FITNESS FOR A PARTICULAR PURPOSE ARE EXCLUDED.



---

# SHOCKS NEED LOVE TOO

---

## FOX SERVICE AND UPGRADES

HAVE YOUR FOX SHOCKS SERVICED BY FOX TECHNICIANS. CALL OUR OFF-ROAD AND TRUCK SERVICE CENTER AT 619.768.1800 TO GO OVER THE SERVICE AND UPGRADE OPTIONS AVAILABLE FOR YOUR PRODUCT. ONCE YOU'VE SETUP YOUR SERVICE AND/OR UPGRADES YOU WILL RECEIVE A RETURN AUTHORIZATION NUMBER AND SHIPPING INSTRUCTIONS.

## COMPLETE SERVICES

100% street use: every 50,000 miles

50% street/ 50% off-road use: Every 10,000 miles

## SERVICE MENUS AND PRICING

visit [ridefox.com/service](http://ridefox.com/service)



**WARNING: Cancer and  
Reproductive Harm –**  
[www.P65Warnings.ca.gov](http://www.P65Warnings.ca.gov)

