

Universal Air Spring Spacer

**Kits 52420,
52440, 52445,
52460 and
52465**

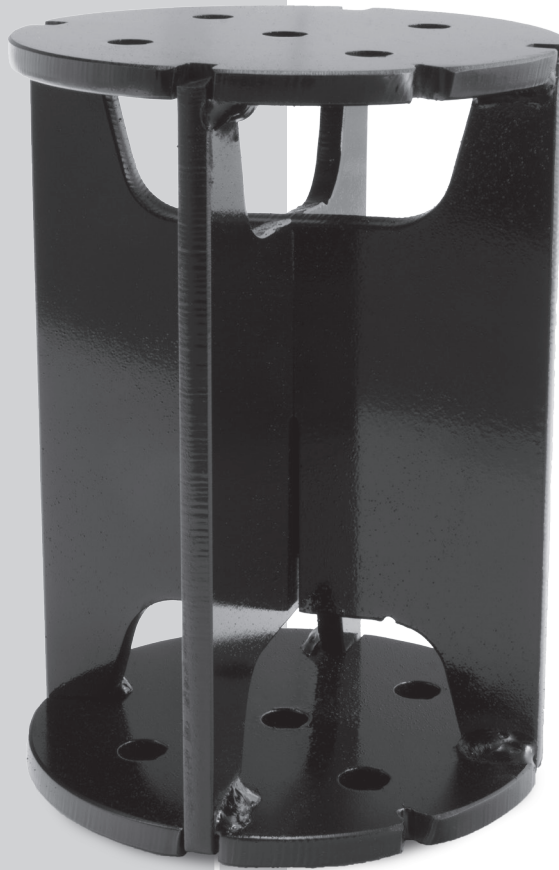

INSTALLATION GUIDE

Go to air-lift.co/liftspacer to determine which spacer is needed for your application.

For maximum effectiveness and safety, please read these instructions completely before proceeding with installation.

Failure to read these instructions can result in an incorrect installation.



TABLE OF CONTENTS

Introduction	3
Important Safety Notice	3
Notation Explanation	3
Important Installation Notice	3
Installation Diagram	4
Hardware List	4
Tools List	4
Preparing to Install the Universal Air Spring Spacer System ..	5
Possible Modifications	5
Maintain Air Spring Clearance	5
Installing Air Spring Lift Spacers	5
Limited Warranty and Return Policy	7
Replacement Part Information	7



Introduction

The purpose of this publication is to assist with the installation of the Universal Air Spring Spacer system.

It is important to read and understand the entire installation guide before beginning installation or performing service or repair. The information here includes a hardware list, tool list, step-by-step installation information and safety information.

Air Lift Company reserves the right to make changes and improvements to its products and publications at any time. Contact Air Lift Company at **(800) 248-0892** or online at **www.airliftcompany.com** for the latest version of this manual.

IMPORTANT SAFETY NOTICE

The installation of this kit does not alter the gross vehicle weight rating (GVWR) or payload of the vehicle. Check your vehicle’s owner’s manual and do not exceed the maximum load listed for your vehicle.

Gross vehicle weight rating: The maximum allowable weight of the fully loaded vehicle (including passengers and cargo). This number — along with other weight limits, as well as tire, rim size and inflation pressure data — is shown on the vehicle’s Safety Compliance Certification Label.

Payload: The combined, maximum allowable weight of cargo and passengers that the truck is designed to carry. Payload is GVWR minus the base curb weight.

NOTATION EXPLANATION

Hazard notations appear in various locations in this publication. Information which is highlighted by one of these notations must be observed to help minimize risk of personal injury or possible improper installation which may render the vehicle unsafe. Notes are used to help emphasize areas of procedural importance and provide helpful suggestions. The following definitions explain the use of these notations as they appear throughout this guide.



INDICATES IMMEDIATE HAZARDS WHICH WILL RESULT IN SEVERE PERSONAL INJURY OR DEATH.



INDICATES HAZARDS OR UNSAFE PRACTICES WHICH COULD RESULT IN SEVERE PERSONAL INJURY OR DEATH.



INDICATES HAZARDS OR UNSAFE PRACTICES WHICH COULD RESULT IN DAMAGE TO THE MACHINE OR MINOR PERSONAL INJURY.

NOTE

Indicates a procedure, practice or hint which is important to highlight.

Important Installation Notice

NOTE

This is a universal kit and may not work on every application. Some lift kit manufacturers may make significant changes to the stock components that could cause the Air Lift kit to not be compatible with their product, meaning the air spring kit may not install properly.

Installation Diagram

NOTE The lift spacer will be installed on the end of the air spring opposite the air spring fitting.

NOTE The orientation of the hardware might need to be changed depending on the application.

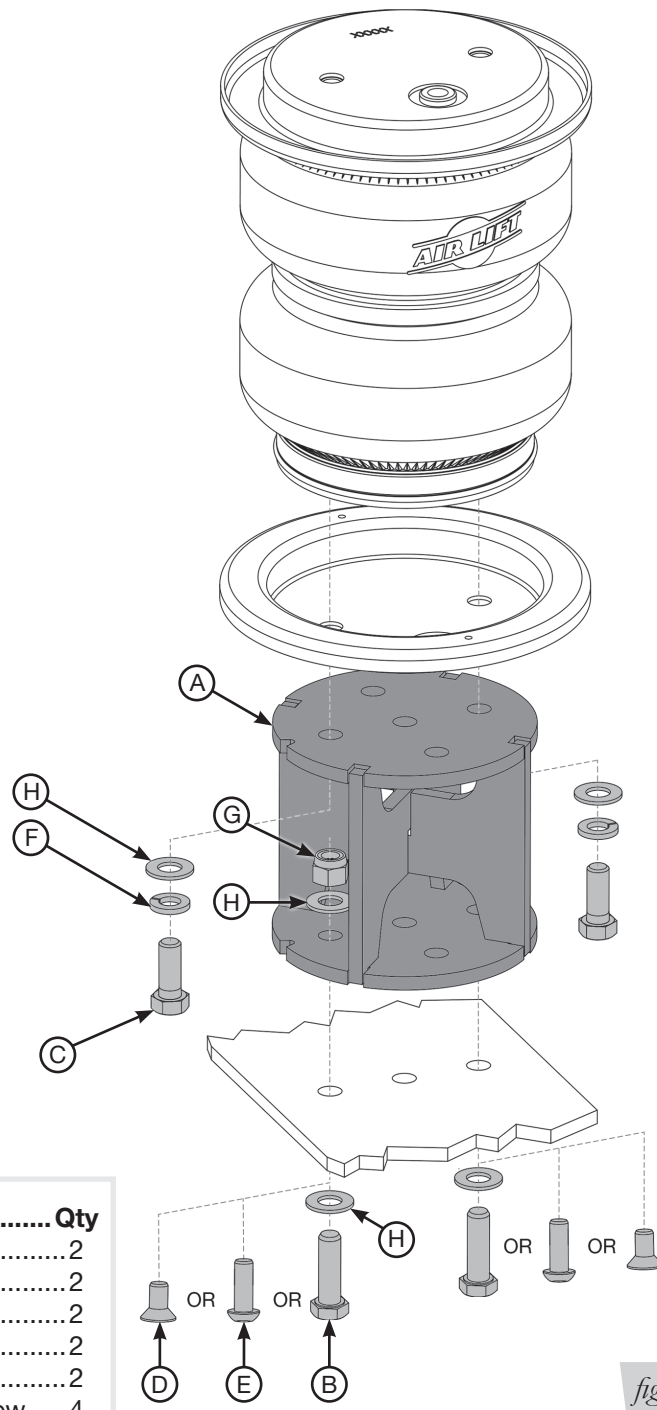

HARDWARE LIST

Item	Description	Qty
A1	13420 2" Lift spacer (52420)*	2
A2	13440 4" Lift spacer (52440)*	2
A3	13460 6" Lift spacer (52460)*	2
A4	13445 4" Angled lift spacer (52445)*	2
A5	13465 6" Angled lift spacer (52465)*	2
B	17188 3/8"-16 x 1 1/4" Hex-head cap screw	4
C	17203 3/8"-24 x 7/8" Hex-head cap screw	4
D	17404 3/8"-16 x 1 1/4" Flat-head socket cap screw	4
E	17926 3/8"-16 x 1 1/4" Button-head cap screw	4
F	18427 3/8" Split lock washer	4
G	18435 3/8"-16 Nylon lock nut	4
H	18444 3/8" Flat washer	12

* Each kit includes two lift spacers

TOOLS LIST

Description	Qty
9/16" Socket	1
9/16" Wrench	1
Ratchet	1
7/32" Hex wrench	1
Torque wrench	1

fig. 1

STOP! Missing or damaged parts? Call Air Lift customer service at (800) 248-0892 for a replacement part.

Preparing to Install Universal Air Spring Lift Spacers

NOTE

Go to air-lift.co/liftspacer to determine which spacer is needed for your application.

POSSIBLE MODIFICATIONS

- Brake line bracket modifications may be needed based on the lift kit manufacturer’s design.
- Most of the time, modifications to the emergency brake line or electrical lines are addressed in the air spring kit’s instruction guide, however, the lift kit manufacturer may have different modifications that may affect this installation.

MAINTAIN AIR SPRING CLEARANCE

- There should be nothing within 1/2” (13mm) of the inflated air spring and its mounting brackets, throughout the full travel of the suspension once the installation is complete.
- This product can be used with other air spring manufacturers’ kits, however, be aware that air spring mounting hardware may be different from what is supplied.

CAUTION

AIR SPRINGS CANNOT SERVE AS THE SUSPENSION LIMITER IN EXTENSION. A SUSPENSION TRAVEL LIMITING DEVICE SUCH AS A LIMIT STRAP MUST BE USED.

Installing Air Spring Lift Spacers

This instruction assumes air springs have previously been installed on the vehicle. If air springs are not currently installed on the vehicle, skip to step four.

1. Release all air from the air springs.
2. Remove the lower bracket from the vehicle.
3. Remove the fasteners that attach the air spring to the lower bracket.
4. On applications that require an angled spacer, the low side of the spacer with the alignment notch points in the direction that best aligns the air spring so the top and bottom mounting surfaces are as close to parallel as possible. Torque the air spring hardware to no more than 20 lb.-ft. (27Nm).

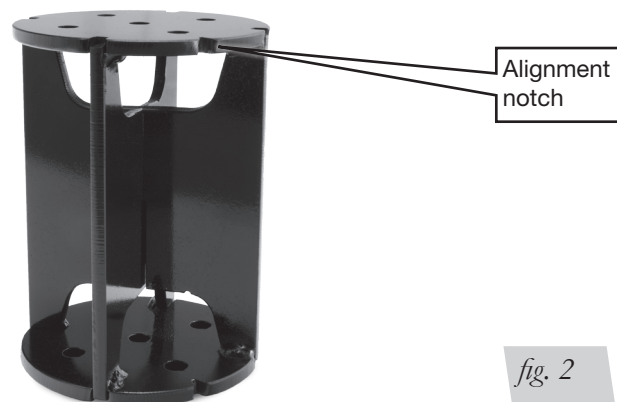
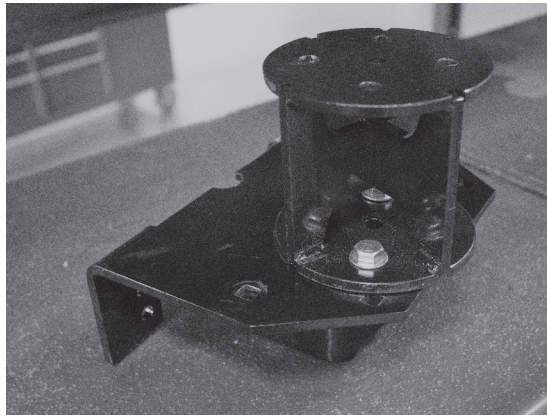
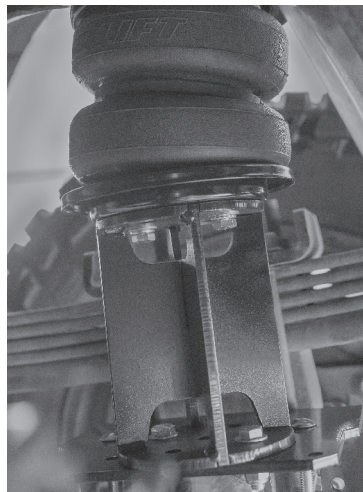

fig. 2

5. Attach the lift spacer to the lower bracket using the longer hardware supplied with the Universal Air Spring Spacer kit (Fig. 3). Depending on the application, hex-head cap screws, flat-head screws or button-head screws will be used to bolt the lower bracket/lift spacers together (Fig. 1). Torque to 31 lb.-ft. (42Nm).

*fig. 3*

6. Attach the lift spacer to the air spring using the new hardware, supplied in this kit (Fig. 1). Torque to no more than 20 lb.-ft. (27Nm).
7. Reattach the lower bracket to the vehicle following the air spring kit's installation guide as specified (Fig 4). Cycle the suspension to make sure the air spring has 1/2" (13mm) of clearance all the way around.



Underframe application shown.

fig. 4

CAUTION

WITH THE AIR SPRINGS INFLATED TO 40-60 PSI (2.8-4.1BAR), MAKE SURE THERE IS AT LEAST 1/2" (13MM) CLEARANCE FROM ANYTHING THAT MIGHT RUB AGAINST EACH AIR SPRING. BE SURE TO CHECK THE CLEARANCE OF TIRES, FRAME, WIRES, HOSES, SHOCK ABSORBERS AND BRAKE LINES, BRACKETS AND CABLES.

Limited Warranty and Return Policy

Air Lift Company provides a limited lifetime warranty to the original purchaser of its Load Support products, that the products will be free from defects in workmanship and materials when used on vehicles as specified by Air Lift Company and under normal operating conditions, subject to the requirements and exclusions set forth in the full Limited Warranty and Return Policy that is available online at www.airliftcompany.com/warranty.

For additional warranty information contact Air Lift Company customer service.

Replacement Part Information

If replacement parts are needed, contact the local dealer or call Air Lift customer service at **(800) 248-0892**. Most parts are immediately available and can be shipped the same day.

Contact Air Lift Company customer service at (800) 248-0892 first if:

- Parts are missing from the kit.
- Need technical assistance on installation or operation.
- Broken or defective parts in the kit.
- Wrong parts in the kit.
- Have a warranty claim or question.

Contact the retailer where the kit was purchased:

- If it is necessary to return or exchange the kit for any reason.
- If there is a problem with shipping if shipped from the retailer.
- If there is a problem with the price.

Contact Information

Mailing address	P.O. Box 80167 Lansing, MI 48908-0167
Shipping address for returns	2727 Snow Road Lansing, MI 48917
Phone	Toll free: (800) 248-0892 International: (517) 322-2144
Email	service@airliftcompany.com
Web address	www.airliftcompany.com

Need Help?

Contact Air Lift Company customer service department by calling (800) 248-0892.

For calls from outside the USA or Canada, dial (517) 322-2144.



Thank you for purchasing Air Lift products — the professional installer's choice!

Air Lift Company • 2727 Snow Road • Lansing, MI 48917 or P.O. Box 80167 • Lansing, MI 48908-0167
Toll Free (800) 248-0892 • Local (517) 322-2144 • Fax (517) 322-0240 • www.airliftcompany.com

Printed in the USA
JJC-1217