

CAN AM 2016-19 DEFENDER CAB HEATER

Thank you for choosing Rough Country for all your UTV needs.

Please read instructions before beginning installation. Check the kit hardware against the kit contents shown below. Be sure you have all needed parts and know where they go.

If question exist, please call us @1-800-222-7023. We will be happy to answer any questions concerning this product.

Check all fasteners for proper torque. Check to ensure for adequate clearance between all components.

Periodically check all hardware for tightness.



TOOLS NEEDED:
2" Hole Saw
Drill Motor
Tape Measure
Marker
Various Sockets/Wrenches
Ratchet
1/8" Drill
Screwdrivers
Knife or Body Saw
Pliers

Manufacturer Approved Engine Coolant
Clamping Pliers

Torque Specs:

Size	Grade 5	Grade 8	Size	Class 8.8	Class 10.9
5/16"	15 ft/lbs	20ft/lbs	6MM	5ft/lbs	9ft/lbs
3/8"	30 ft/lbs	35ft/lbs	8MM	18ft/lbs	23ft/lbs
7/16"	45 ft/lbs	60ft/lbs	10MM	32ft/lbs	45ft/lbs
1/2"	65 ft/lbs	90ft/lbs	12MM	55ft/lbs	75ft/lbs
9/16"	95 ft/lbs	130ft/lbs	14MM	85ft/lbs	120ft/lbs
5/8"	135ft/lbs	175ft/lbs	16MM	130ft/lbs	165ft/lbs
3/4"	185ft/lbs	280ft/lbs	18MM	170ft/lbs	240ft/lbs

1. Remove the passenger grab bar and removable glove box.
2. Remove the lower dash panel. **See Photo 1.**
3. Cut and remove the middle cubby hole. **See Photo 2.** There are two bolt holes that you **DO NOT** cut off. **See Photos 3 & 4.**



4. Make the bottom cut roughly an inch in off the molding depressions (PIC05). **See Photo 5.**
5. Remove the radiator line cover located on the firewall (PIC06). Cut a 2-3" hole as shown in. **See Photo 6.** Use a razor blade to cut an opening through the top edge of the panel. **See Photo 7.**



6. Lift the passenger seat and remove the tool box. **See Photo 8.**

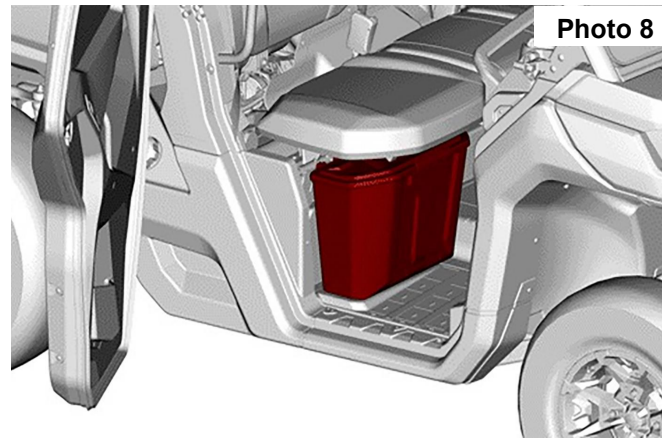

7. Remove the passenger side center floor panel (PIC09). **See Photo 9.**

8. Remove the passenger side under-seat panel (PIC10). **See Photo 10.**

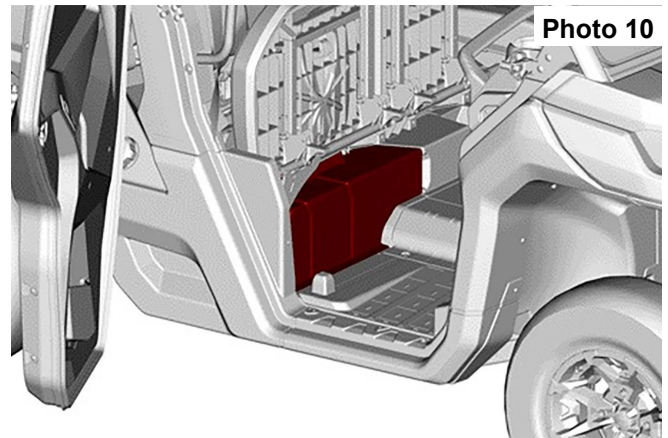
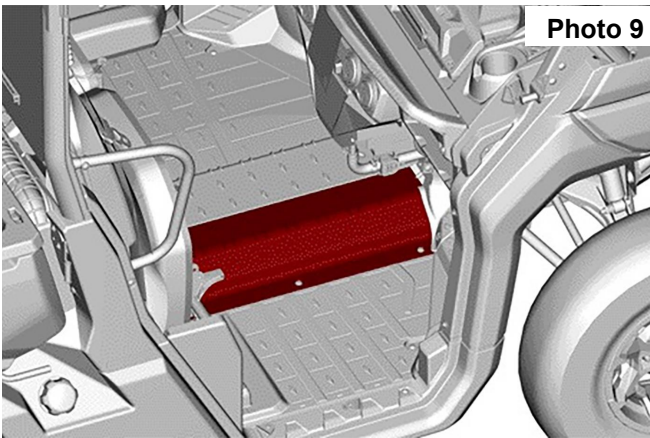

9. Using the circle cut out templates, set the templates and mark your hole-saw bit starting points.

10. Using a 2" hole-saw drill out the holes for the louvers. **See Photo 11.** You will need to use a blade and enlarge the hole 1/16" of an inch for the louver adapter to fit easily through the hole.

11. Install the (2) floor louvers and leave this bottom dash piece to be installed later in the installation. **See Photo 12.**

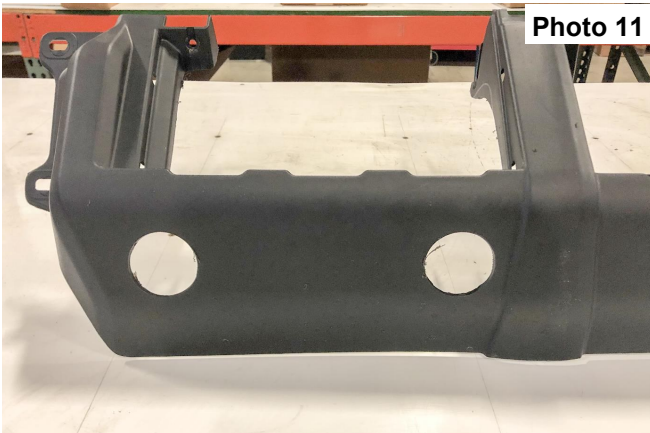

12. To begin installation of defrost and body louvers, use a razor blade knife to cut out the WARNING sticker on the middle dash panel. **See Photo 13.** For ease of cutting, use a torch to heat the blade. There is a plastic rib behind the area of the plastic panel you are cutting out **See Photo 13**, remove this rib with the blade as well.
13. Cut piece of duct at 12", 12" and 18" and connect them to the Duct Y-Fitting. **See Photo 14.**

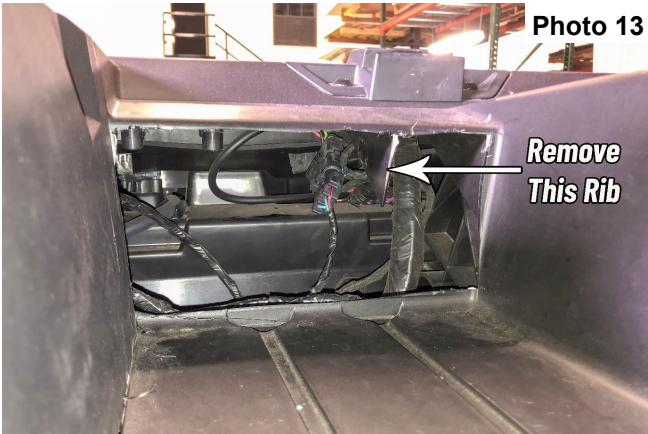

Photo 13

**Remove
This Rib**

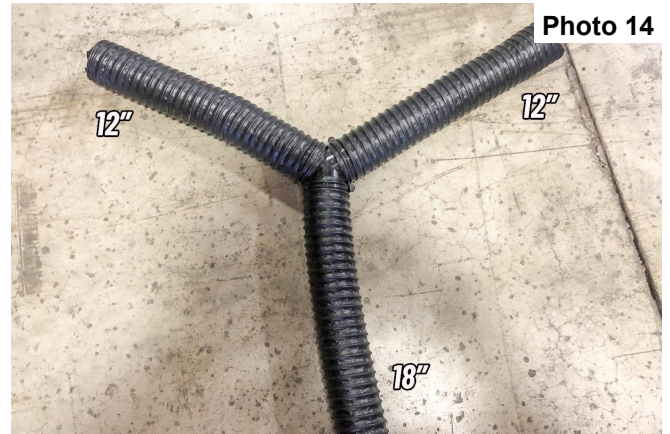

Photo 14

14. Feed the 18" piece of duct through the dash panel opening (**See Photo 15**) and leave hang (**See Photo 19**) below to be attached to the heater box later in the installation.
15. Cut a 24" piece of duct and feed through the middle of the dash panel opening (**See Photo 16**) and leave the duct hang (**See Photo 19**) below to be attached to the heater box later in the installation.

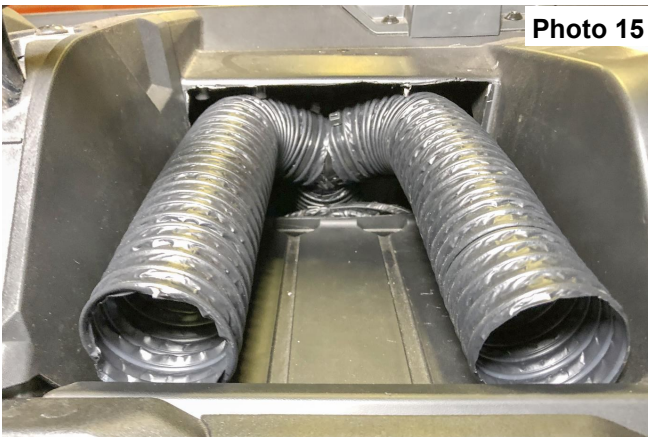

Photo 15



Photo 16

16. Using the center mounting plate included in the kit, take the wiring harness and connect the switch connector to the back of the rocker switch. **See Photo 17.**
17. Feed the wires through the dash panel cut out opening and feed down below, following the path of the duct (**Photo 17**). **See Photo 17.**
18. Connect the Red/Black wire to the 12v power accessory bar located under the center dash. **See Photo 18.** Leave the blower connector hang (**See Photo 19**) for later in the installation when you install the heater box.

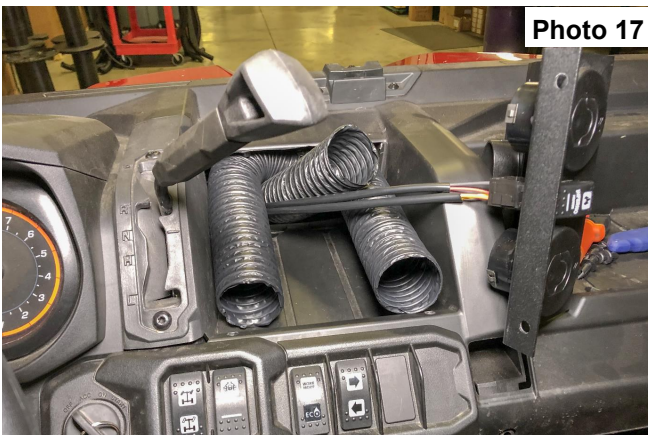

Photo 17

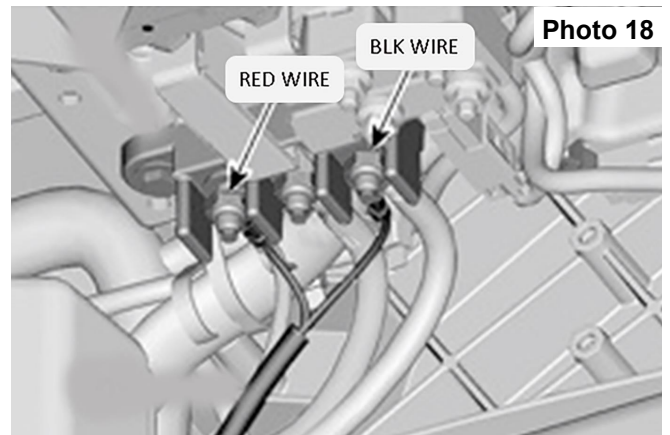
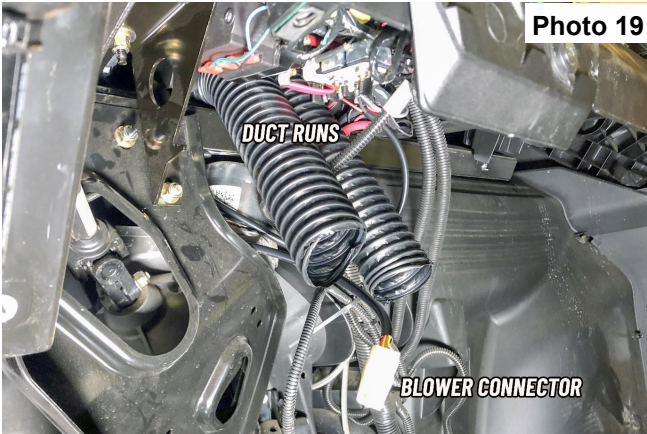
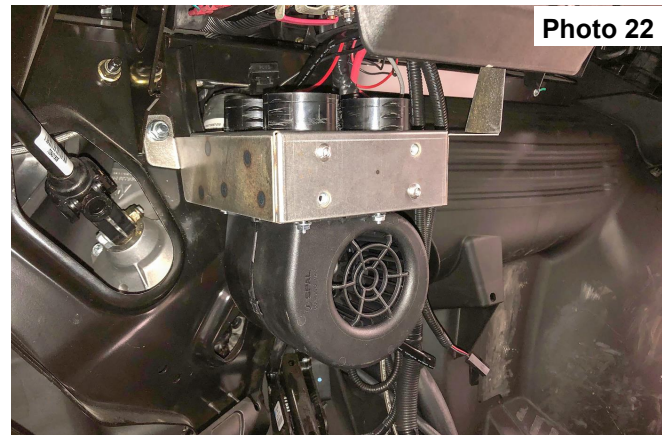
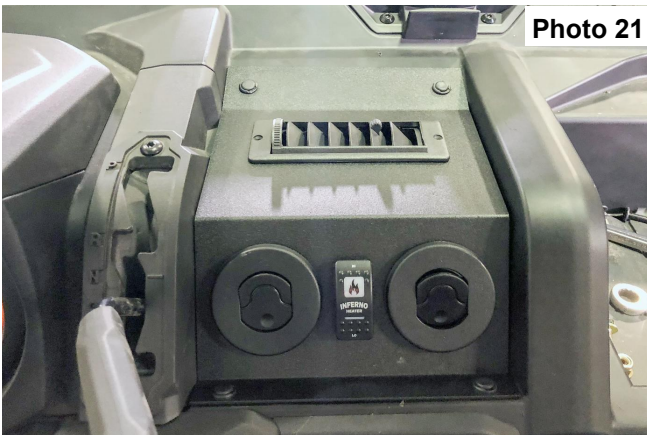

Photo 18

19. Connect the outside runs of the duct to the (2) circular body louvers (**See Photo 20**) and secure with the zip ties provided. Use the duct barbs on the adapter for extra hold.
20. Connect the middle run of duct to the defrost vent (**See Photo 20**) and secure with the zip ties provided.
21. Set the center mounting plate in place and use a 5/16" drill bit to pilot the two front holes. Line the front edge right on the edge of the center dash. Make sure the surface area that you will pilot holes into are flat. If you can see the rounded edge you are too far back.



22. Install the (2) plastic rivets in the front holes. **See Photo 21.**
23. Push the back edge of the center mounting plate down and use the drill bit to pilot the two back holes.
24. Install the (2) plastic rivets in the back holes. **See Photo 21.**
25. Using the bolt, washer and nut provided in the kit, mount the driver side heater bracket under the center dash. **See Photo 22.** You will not mount the passenger side bracket until later in the installation when you put the lower dash panel back on the machine. Remove the Factory Bolt and Nut that are in the mounting point and dispose. Connect the (2) runs of duct to the back heater box adapters. Trim the duct to length as you do not want too much duct pushing around in that small area.
26. Connect the white connector from the wiring harness to the heater blower.
27. Turn on the power and test the blower.



27. Find the lower (return) radiator line from inside the cab. **See Photo 23.** The lower (return) radiator line sits behind the upper (inlet) line in the cab. In this spot the hoses can be easily moved, so pull the return line out to a workable spot.
28. Using clamps, clamp off on each side of the lower radiator line where you will cut in to install the 1" Y-Fitting (**PICT23**), once installed, secure with the hose clamps provided. Make sure the 5/8" splice is pointing toward the radiator (in this case the splice will be pointing towards the sky), you want the coolant to flow back into the lower radiator line in the same direction it is moving from the radiator.
29. Cut a 2-foot piece of heater hose and run it from the Y-Fitting to the heater box (doesn't matter which fitting). Secure with the hose clamps provided.
30. Raise the bed and find the upper (inlet) radiator line. **See Photo 24.** Take the pin out of the bed strut so you can raise it back further and have more room to work.
31. Using clamps, clamp off on each side of the upper (inlet) radiator line where you will cut in to install the 1" Y-Fitting. **See Photos 24 & 25.** Once installed, secure with the hose clamps provided. Make sure the 5/8" splice is pointing toward the radiator (in this case the splice will be pointing towards the ground), you want the coolant to flow off of the inlet radiator line (to the splice) in the same direction it is moving from the engine.

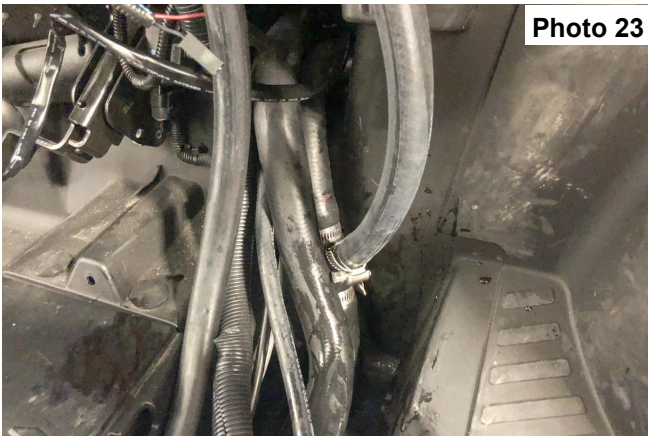

Photo 23

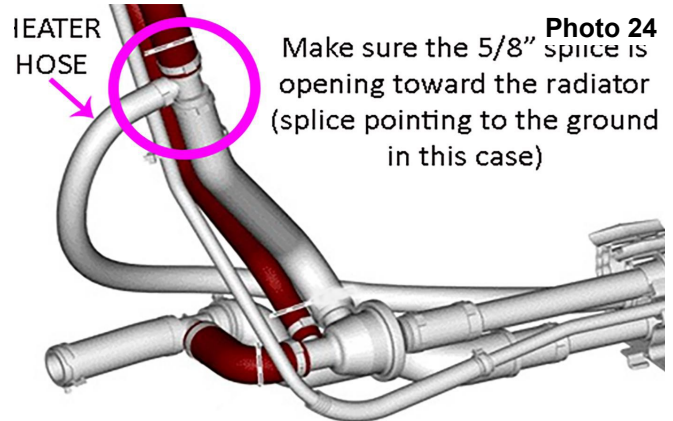

Photo 24

32. Run the remaining heater hose from the Y-Fitting to the heater box (doesn't matter which fitting). Secure with the hose clamps provided. **See Photo 25.**
33. Put the 3 floor panels back on in the cab and feed the hose through the opening that was previously cut. **See Photo 26.**
34. Cut an 18" (driver side floor louver) and 24" (passenger side floor louver) and attach them to the two front heater box adapters.

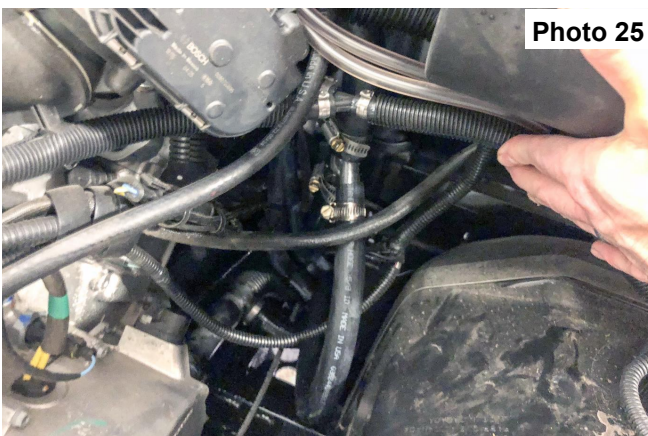

Photo 25

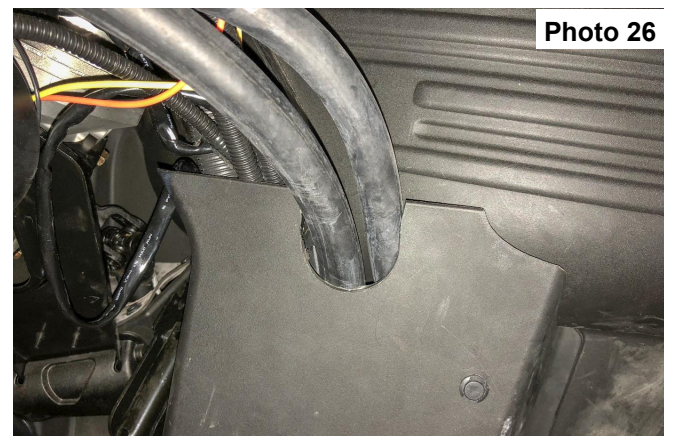

Photo 26

35. Before setting the lower dash panel back in place, connect the two runs of duct to the floor louver adapters. Use the duct barbs on the adapters for extra hold. Wrap the passenger side duct around the backside of the passenger side mounting bracket, you will need it out of the way of the mounting screw. **See Photo 27.**
36. Reinstall the lower dash panel **except for** the screw for the mounting point of the passenger side mounting bracket.
37. Using a partner, have the partner maneuver the heater box in place so the mounting bracket hole mirrors the mounting hole. The lower dash panel will be in between the bracket and the machine so it will be mounted by the screw as well. **See Photo 27.**
38. Install the middle cubby block-off plate.
39. Install one side of the tabs and then push in of the middle of the plate to make room to get the other side tabs fit. You can run your hand underneath to help hold the backside. Plastic moves so if the plate is too tight you can loosen the bolts by the steering wheel to create more space, or you can take a razor blade and shave down the cubby block-off at the spot where it is tight. **See Photo 28.**

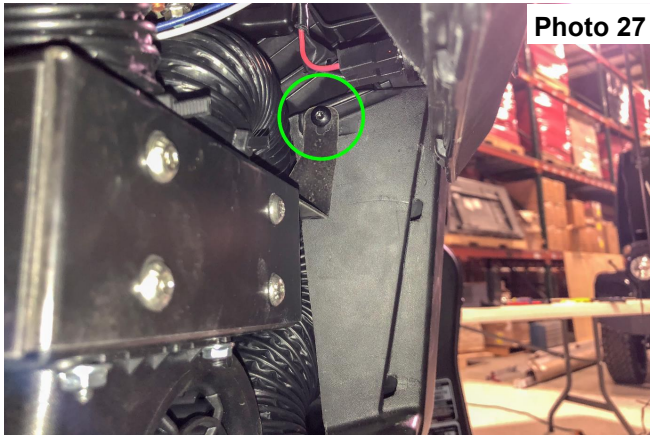

Photo 27

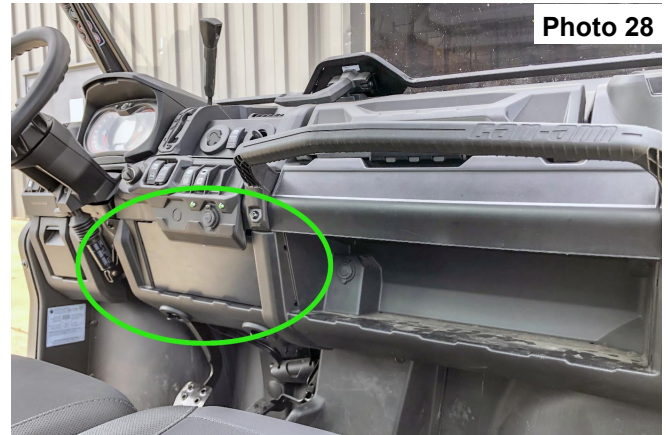

Photo 28

40. Refill the radiator and check for leaks.
41. Start the machine and allow the engine to warm up and circulate the coolant.
42. Drive the vehicle and put it under a good load, this will help expel air from the system.
43. When done let the machine cool down, recheck the coolant level and refill if needed.
44. Coolant will be consumed as the air is expelled from the system. It is possible you will need to run the machine and recheck fluid levels multiple times before working out all of the air.

Thank you for choosing Rough Country for all your UTV needs.

By purchasing any item sold by Rough Country, LLC, the buyer expressly warrants that he/she is in compliance with all applicable, State, and Local laws and regulations regarding the purchase, ownership, and use of the item. It shall be the buyers responsibility to comply with all Federal, State and Local laws governing the sales of any items listed, illustrated or sold. The buyer expressly agrees to indemnify and hold harmless Rough Country, LLC for all claims resulting directly or indirectly from the purchase, ownership, or use of the items.



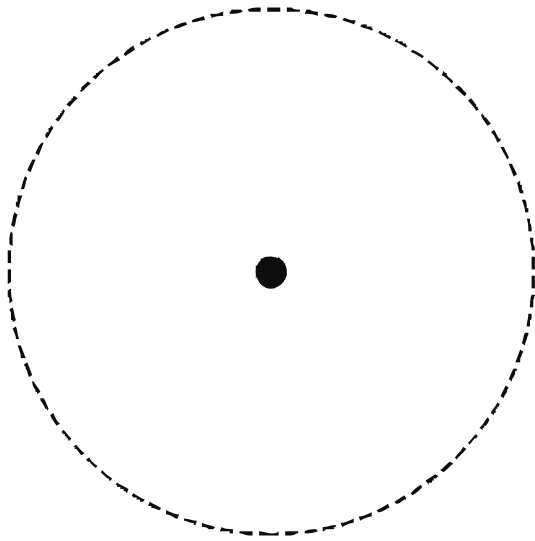

M
-
I
D
D
L
E

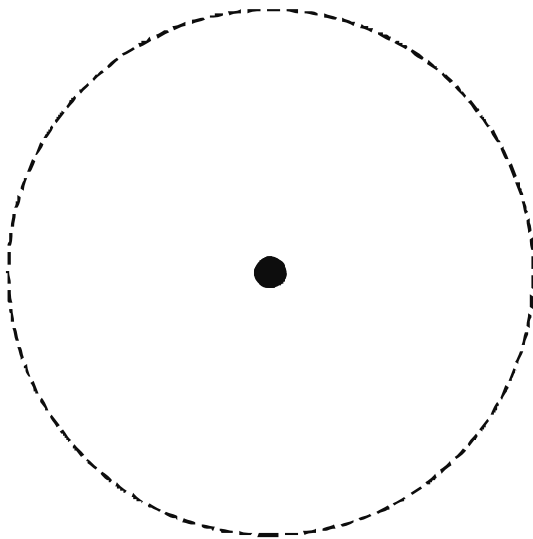
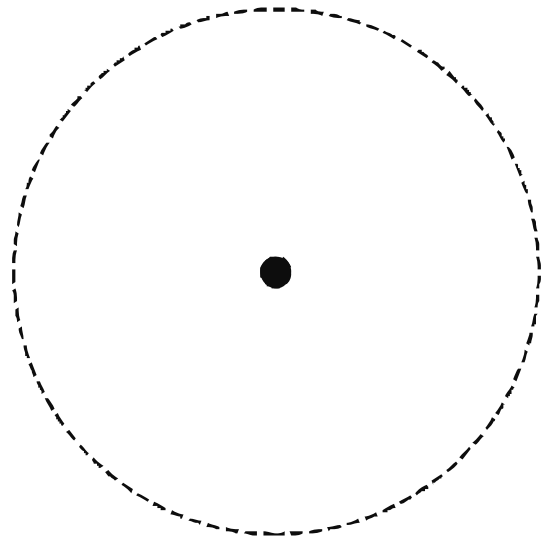

Cut Out Templates are size of the louver face (NOT hole-saw cut-out). Use this to mark the spot to start the hole-saw bit.