

ROUGH COUNTRY

SUSPENSION SYSTEMS

2015 COLORADO 1.25" BODY LIFT

Thank you for choosing Rough Country for all your suspension needs.

⚠ WARNING Rough Country recommends a certified technician install this system. In addition to these instructions, professional knowledge of disassemble/reassembly procedures as well as post installation checks must be known. Attempts to install this system without this knowledge and expertise may jeopardize the integrity and/or operating safety of the vehicle.

Please read instructions before beginning installation. Check the kit hardware against the parts list on this page. Be sure you have all needed parts and know where they go. Also please review tools needed list and make sure you have needed tools.

PRODUCT USE INFORMATION

⚠ WARNING As a general rule, the taller a vehicle is, the easier it will roll. Seat belts and shoulder harnesses should be worn at all times. Avoid situations where a side rollover may occur.

⚠ WARNING Generally, braking performance and capability are decreased when larger/heavier tires and wheels are used. Take this into consideration while driving. Do not add, alter, or fabricate any factory or after-market parts to increase vehicle height over the intended height of the Rough Country product purchased. Mixing component brands is not recommended.

Rough Country makes no claims regarding lifting devices and excludes any and all implied claims. We will not be responsible for any product that is altered.

⚠ WARNING This body lift was developed using a 265/70/17 tire with factory wheels. **Note:** If offset wheels are used trimming may be required.

If you have any questions concerning the design, function, and correct use of our products please contact us at 800-222-7023.

NOTICE DEALER AND VEHICLE OWNER

Any vehicle equipped with any Rough Country product should have a Warning to Driver+decal installed on the inside of the windshield or on the vehicle's dash. The decal should act as a constant reminder for whoever is operating the vehicle of its unique handling characteristics.

INSTALLING DEALER - it is your responsibility to install the warning decal and forward these installation instructions on to the vehicle owner for review. These instructions should be kept in the vehicle for its service life.

Tools Needed:

- 7mm Socket
- 10mm Socket/Wrench
- 15mm Socket/Wrench
- 18mm Wrench
- 21mm Socket
- 9/16+Socket/Wrench
- T15 Torx
- T45 Torx
- 13/32+Drill bit
- 11/32+Drill bit
- Screw Drivers

1. Park the vehicle on a smooth level surface.
2. Remove the 6 bolts on the upper fascia with a T15 torx bit. **See Photo 1.**
3. Using a 7mm socket, remove the inner corner supports. **See Photo 2.**



Photo 1

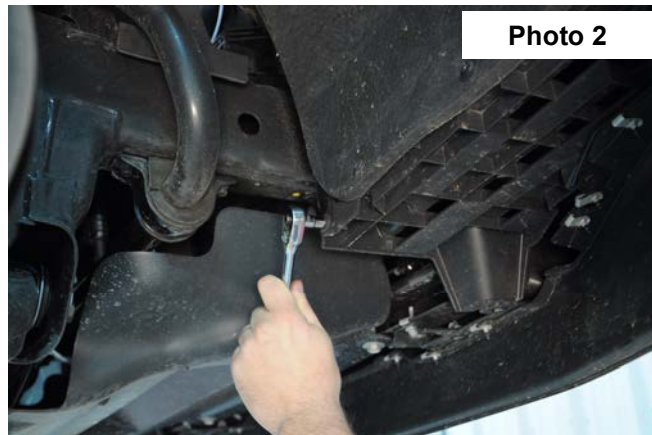

Photo 2

4. If the vehicle is equipped with factory fender flares, they will have to be removed. Use a T15 torx bit to remove the factory bolts and then pull loose the double sided tape that hold the flare to the fender. **See Photo 3.** Remove the 4 inner fender bolts with a T15 torx bit as you pull loose the factory flare. **See Photo 4.**
5. If the vehicle doesn't have factory fender flares, remove the 7 inner fender bolts with a T15 torx bit.

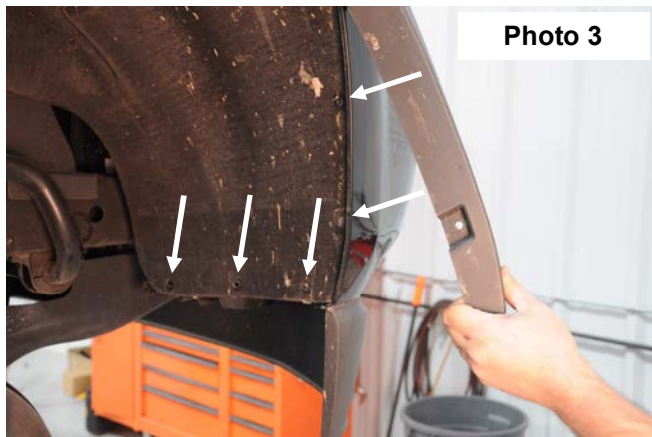

Photo 3



Photo 4

6. Pull the inner fender back to gain access to remove the bumper bolts with a 7mm socket. **See Photo 5.**

3



Photo 5

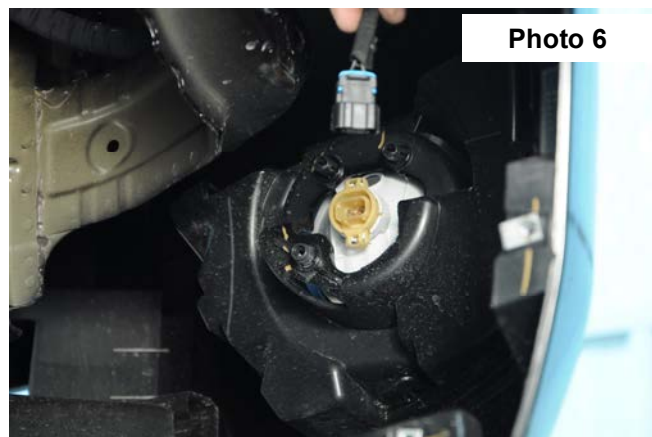
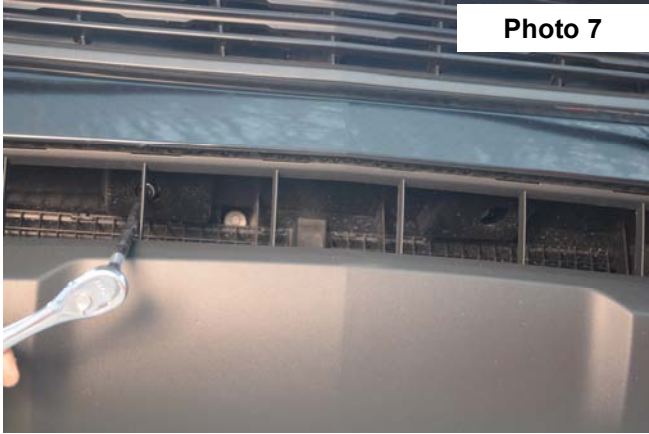

Photo 6

7. Disconnect the plugs to the fog lights. **See Photo 6.**

8. Remove the 2 front fascia bolts with a 10mm socket. **See Photo 7.**
9. Using a 10mm socket remove the 2 lower fascia bolts from the frame . **See Photo 8.**
10. Now carefully remove the front bumper and fascia.



11. Remove the 4 bolts holding the crash bar to the frame with a 15mm socket . **See Photo 9.**
12. Remove the crash bar and foam insert from the tow hooks . **See Photo 10.**

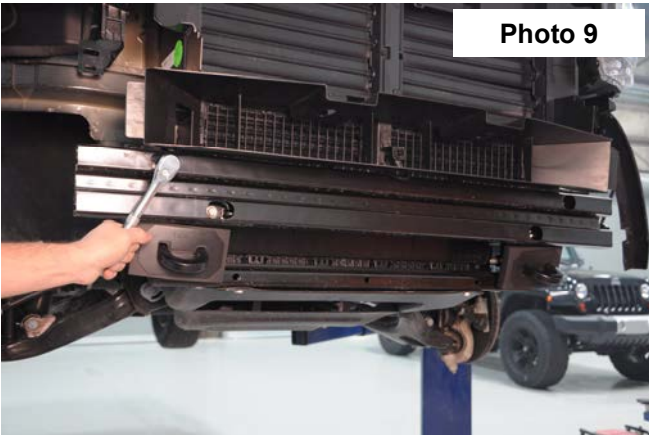

13. Record the measurement of the thread length on the parking brake cable. **See Photo 11.**
14. Next remove the cable nut with a 10mm wrench while holding the cable crimp with vise grips. **See Photo 12.**

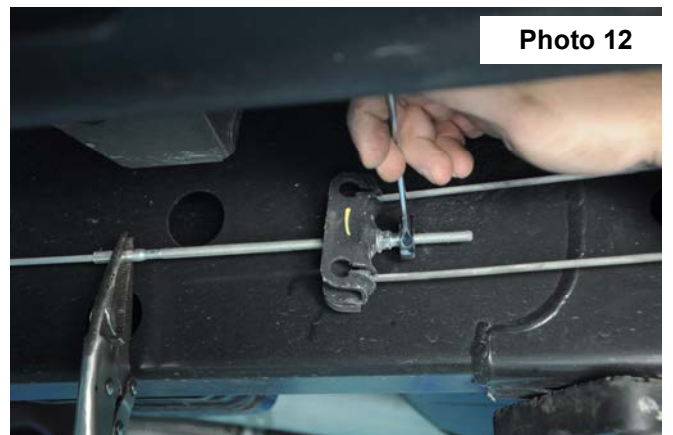
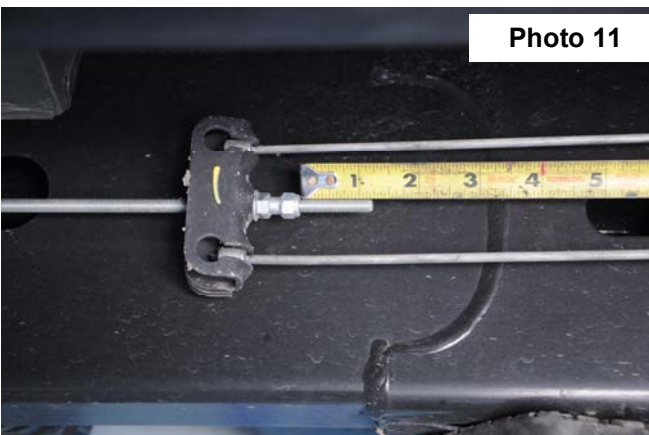

15. Starting on the passenger side, remove the 4 cab bolts with a 21mm socket. **See Photo 13.** Next loosen the 4 cab bolts on the driver side but do not remove.
16. Using a jack and a block of wood, raise the passenger side up off the frame mounts.



17. Insert the 1.25x 3.0+body pucks on the 4 passenger side body mounts. **See Photo 15.** Insert the supplied 14mm x 130mm bolts and washers. Hand tighten. Next raise the driver side and insert the body pucks and secure with 14mm x 130mm bolts and washers. Tighten all supplied cab bolts to 100 ft/lbs.
18. Now loosen the drive side bed bolts with a 18mm socket but do not remove. Remove the passenger side bed bolts and raise the bed with the block of wood and a jack. **See Photo 16.**



19. Place 1.25x 2.0+body puck with the nose in the center location with the nose facing up. **See Photo 17.**
20. Insert the standard 1.25x 2.0 body pucks on the other bed mounts and secure with the supplied 12mmx 65mm bolts and washers. Hand tighten. Raise the driver side and insert the body pucks, then secure with the supplied 12mm x 65mm bolts and washers. Tighten all supplied bed bolts to 60 ft/lbs.



21. Install the passenger front bumper bracket with the supplied 10mm x 30mm flat head bolt and a factory bolt the lower corner. **See Photo 19.**
22. Next drill out the frame horn with a 13/32+drill bit using the bracket as a template. **See Photo 20.** Remove the factory bolt after drilling. Repeat on driver side.

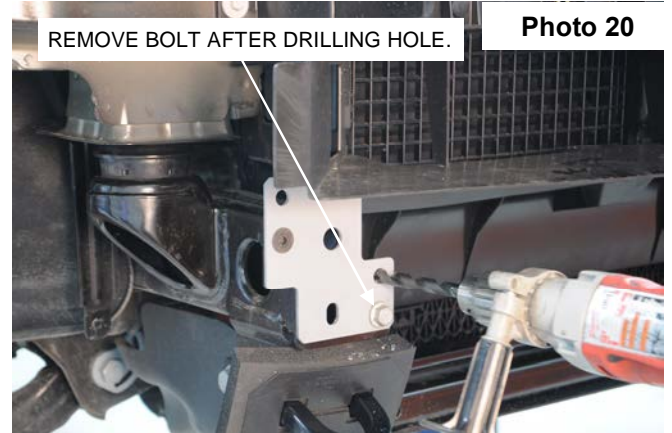
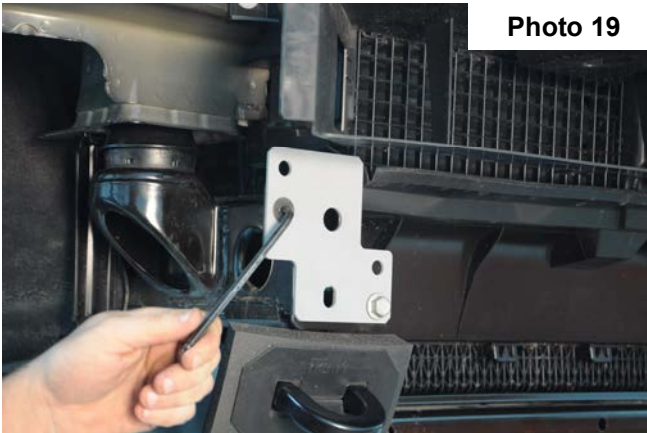

23. Install the crash bar onto the new bumper brackets using the factory bolts and supplied 10mm nylocks. Tighten with a 15mm wrench. **See photo 21 & 22.**

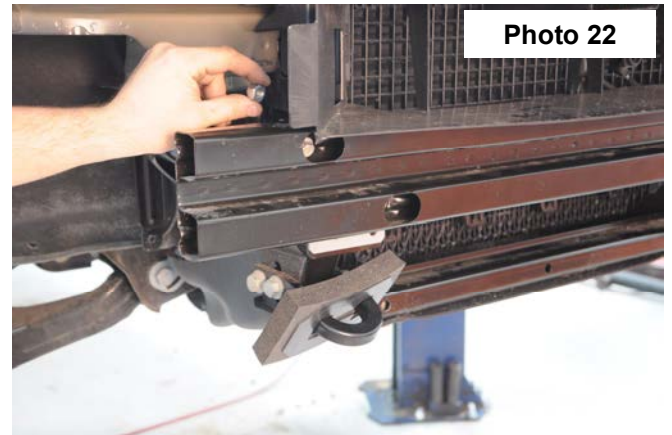
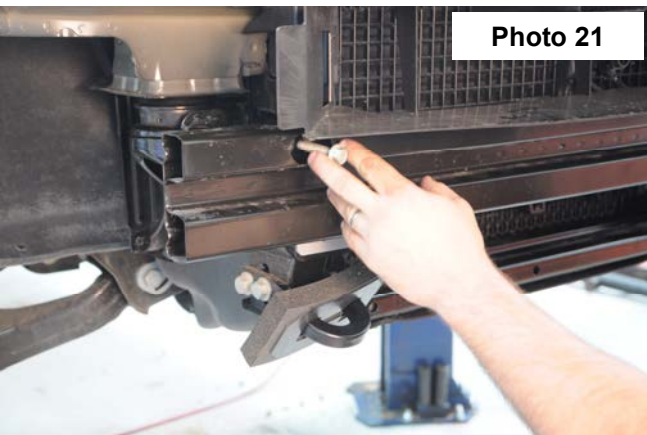

24. Remove the lower bumper fascia brackets with a T15 torx bit. **See Photo 23.**
25. Using pliers, remove the retainer clips on the factory bracket. **See Photo 24.** Retain factory retainer clips.

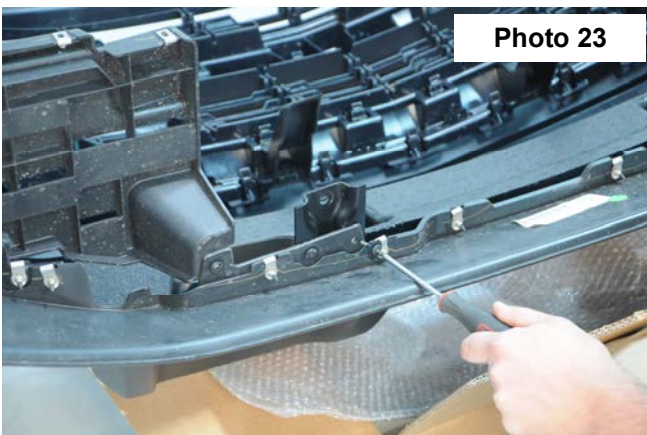

26. Remove the factory tow hooks with a 18mm wrench and socket. **See Photo 25.** Retain factory hardware.
27. Next flip the tow hooks over as shown in **Photo 26** and secure with factory hardware.



28. Insert the factory retainer clips into the new supplied lower bumper fascia brackets. **See Photo 27.**
29. Next attach the new brackets to the lower fascia with the factory hardware. Tighten with T15 torx bit. **See Photo 28.**



30. Reinstall the bumper and fascia, start 2 of the upper fascia screws to hold the bumper into place. Hold the air duct up over the internal foam while securing the bumper and fascia. **See Photo 29.**
31. Pull the inner fender back and reinstall the 3 factory bumper bolts using a 7mm socket. **See Photo 30.**



32. Reinstall the front 2 fascia factory bolts with a 10mm socket. **See Photo 31.**
33. Use factory hardware attach the new supplied lower fascia bracket to the frame support with a 10mm socket as shown in **Photo 32.**

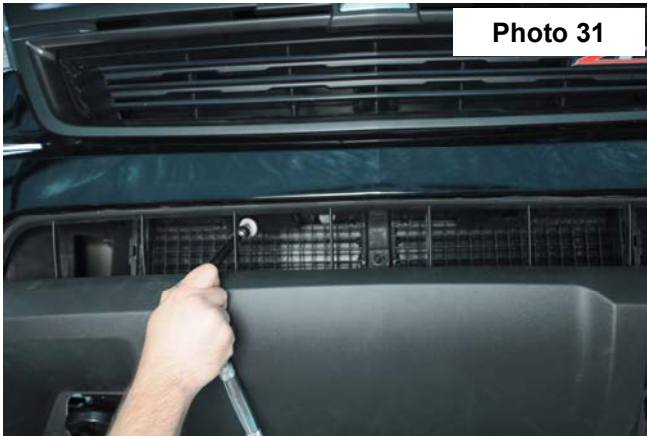

Photo 31



Photo 32

34. Install the lower bumper supports with factory hardware and tighten with a 7mm socket. **See Photo 33.**
35. Attach the inner fender with the factory fender screws and push pins. Tighten with a T15 torx bit. **See Photo 34.**

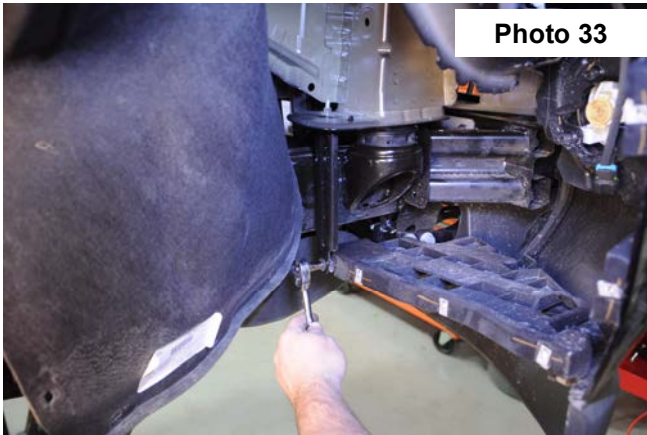

Photo 33



Photo 34

36. If equipped with fender flares, apply new double side tape to the top edge of the fender flare and install the factory bolts. Tighten with a T15 torx bit. **See Photo 35.**
37. Install all of the upper fascia screws and tighten with a T15 torx bit. **See Photo 36.**
38. Reconnect the wire harness for the factory fog lights.



Photo 35



Photo 36

39. Disconnect the e-brake cable and pull the cable back through the frame mount. **See Photo 37.**
40. Place e-brake template onto the rear side of the cab mount as shown in **Photo 38** and drill with a 11/32+drill bit. De-burr and paint the body mount to prevent rusting.



Photo 37

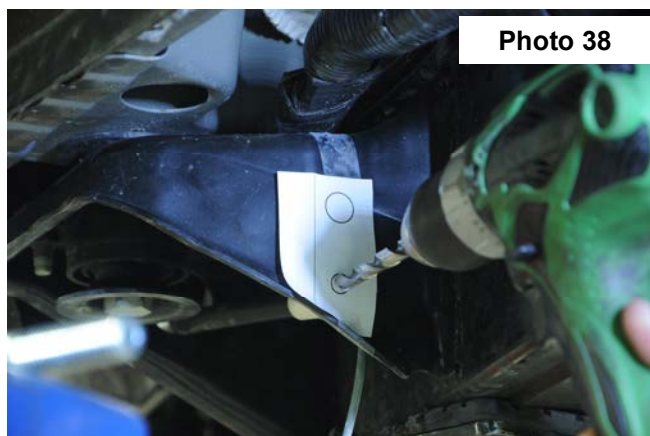

Photo 38

41. Locate the supplied e-brake bracket and slide onto the cable. Pull the e-brake cable back through the body mount and secure the bracket to the body mount with the supplied 3/8+x 1.0+bolt, washer, and nut. Tighten with a 9/16 socket and wrench. **See Photo 39.**
42. Using the two supplied brake line extensions and insert them into the cable bracket as shown in **Photo 40.**

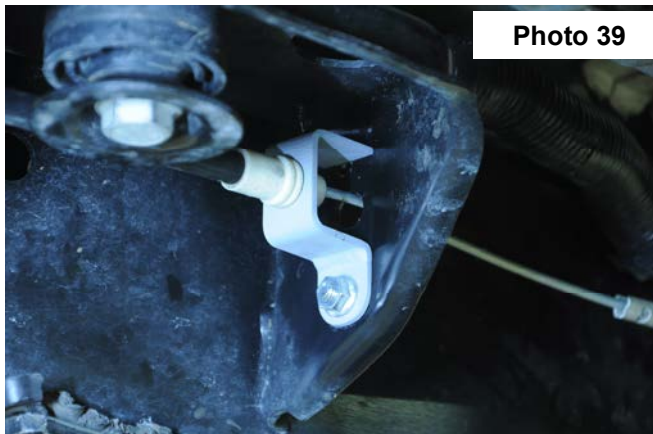

Photo 39



Photo 40

43. Insert the two rear cables into the brake line extensions and reinstall the factory nut that holds tension on the bracket. **See Photo 41.**
44. Adjust the nut until you reach the measurement recorded earlier. You should have about 1.25+of threads behind the nuts. **See Photo 42.**

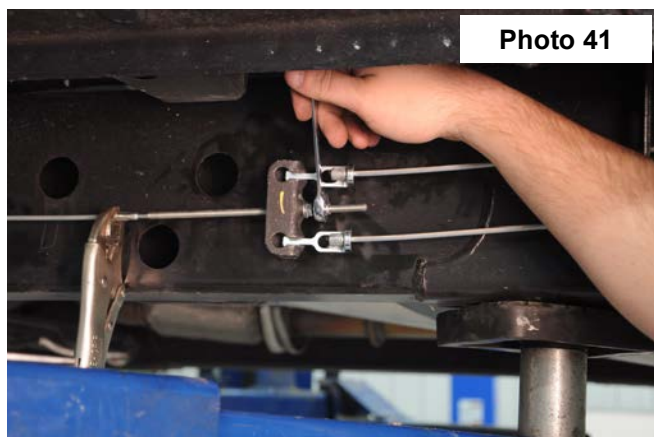

Photo 41

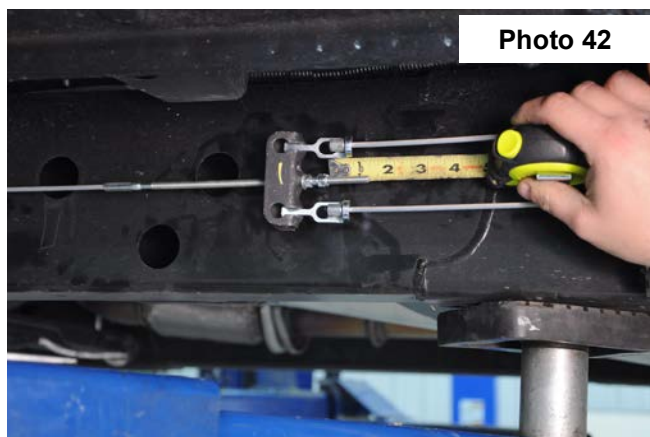

Photo 42

45. Disconnect all electrical plugs from the frame going to the rear bumper. **See Photo 43 & 44.**



Photo 43

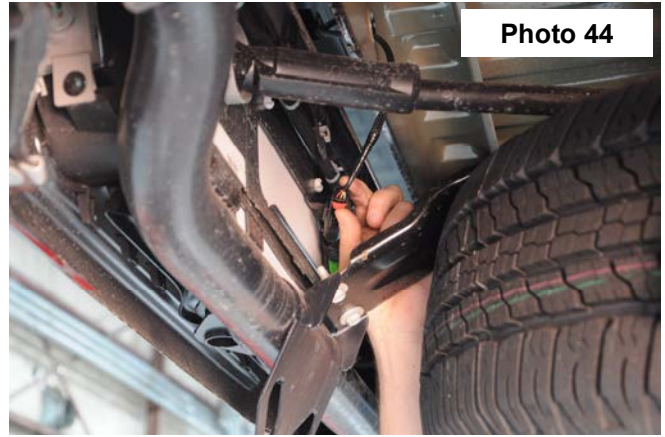

Photo 44

46. Remove the bumper bolts using a 21mm socket. **See Photo 45.**

47. Remove the rear bumper from the vehicle. **See Photo 46.**

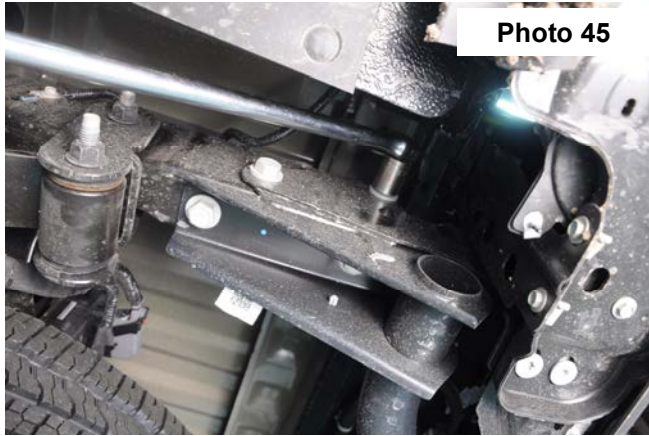

Photo 45



Photo 46

48. Use a flat head screw driver to help push in on the clips so the bumper cover can be raised to gain access to the upper bumper bracket bolts. **See Photo 47.**

49. Remove the two top bumper bracket bolts with a T45 torx bit. **See Photo 48.**

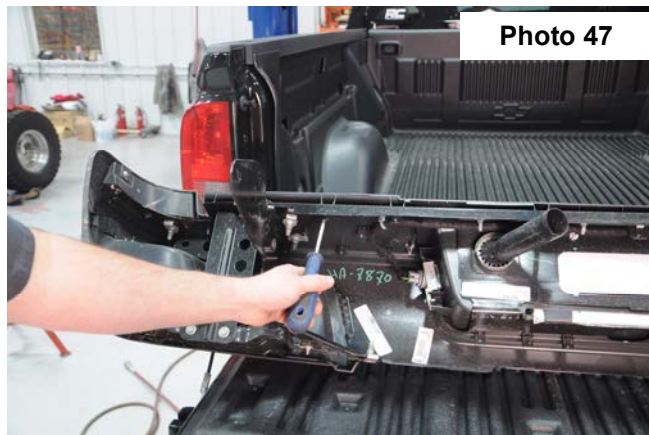
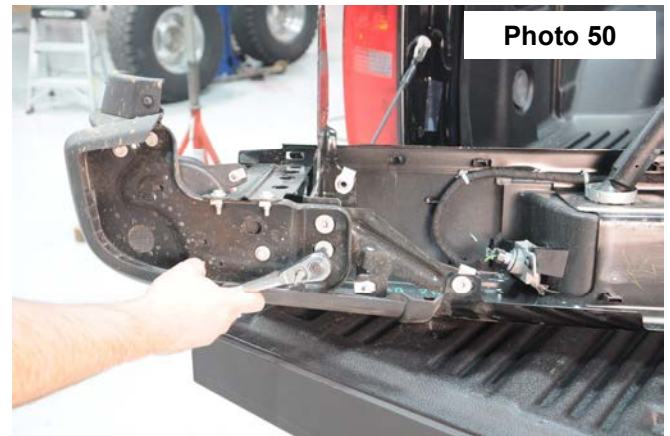
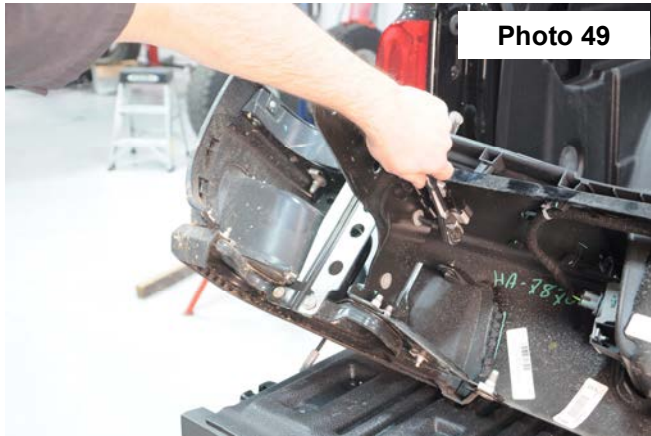

Photo 47



Photo 48

50. Using a T45 torx bit remove the side and bottom bolts on the bumper bracket. **See Photo 49 & 50.**



51. Remove the bumper bracket from the bumper as shown in **Photo 51**. Next repeat steps on the passenger side rear bumper bracket.

52. Use a screw driver to remove the threaded clips from the bumper brackets. **See Photo 52.**

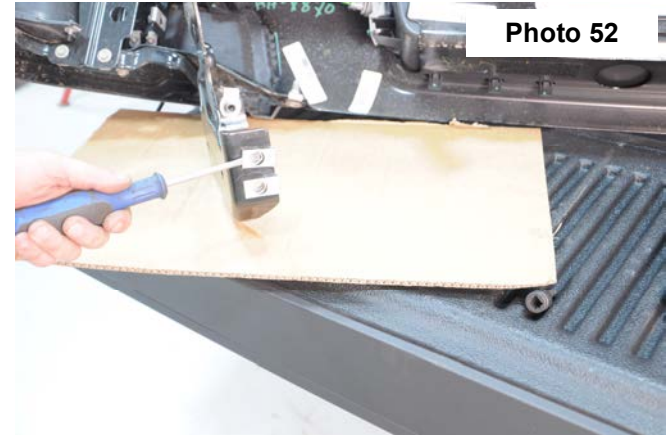
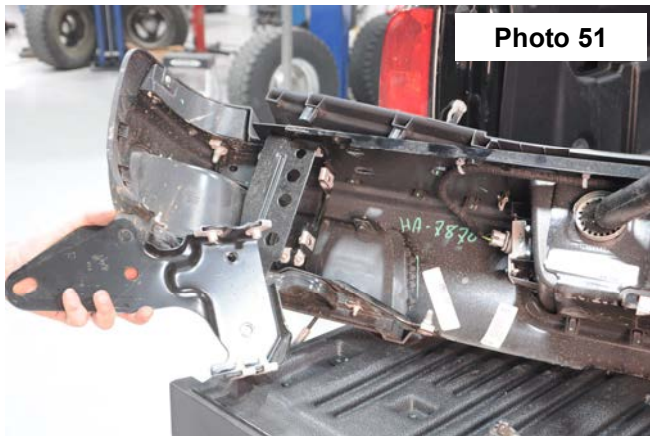

53. Install the factory threaded clips onto the new supplied rear bumper relocation brackets as shown in **Photo 53**.

54. Slide the new relocation bracket back into the bumper in the same position as the factory bracket. **See Photo 54.**

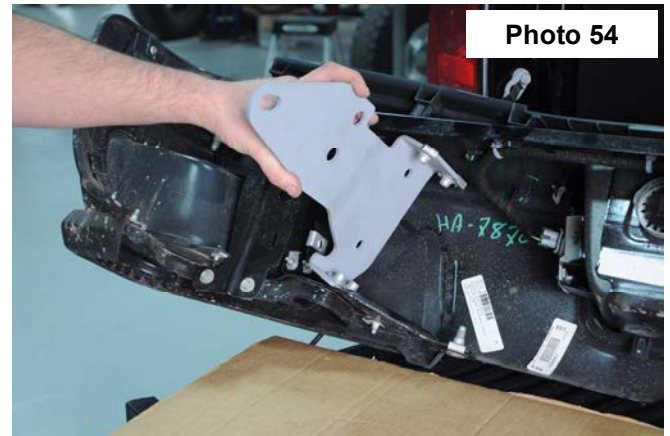
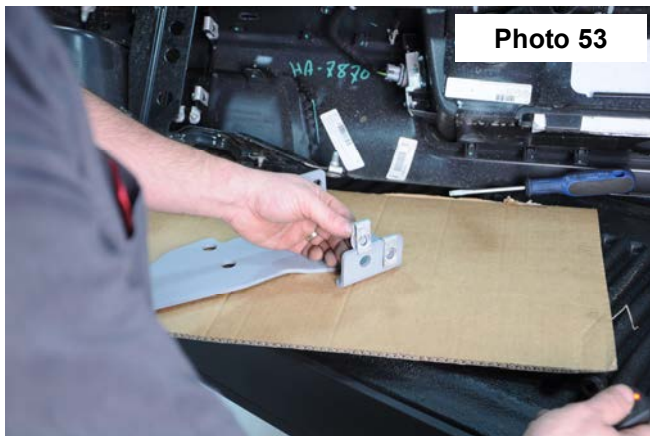

55. Install all 6 factory bolts securing the bumper relocation bracket with a T45 torx bit. **See Photo 55.** Push down on the bumper cover to make sure all clips are locked into place.

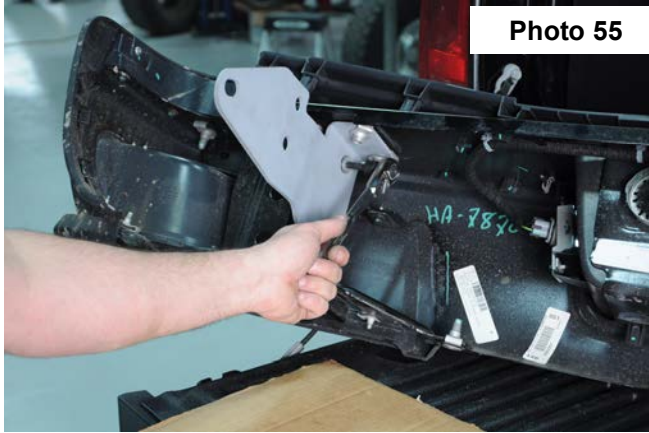

56. If the vehicle is equipped with a tow bar, place the bumper support tube in place and align the two holes. See Photo 56.
57. Install the 3/8-x 1.0+bolts, washers, and nuts to secure the bumper support to the tow bar. See Photo 57.
58. Install the bumper and secure with the factory bolts. Tighten with a 21mm socket. Look to make sure the bumper is aligned with the truck. Reconnect all electrical plugs.



By purchasing any item sold by Rough Country, LLC, the buyer expressly warrants that he/she is in compliance with all applicable Federal, State, and Local laws and regulations regarding the purchase, ownership, and use of the item. It shall be the buyers responsibility to comply with all Federal, State and Local laws governing the sales of any items listed, illustrated or sold. The buyer expressly agrees to indemnify and hold harmless Rough Country, LLC for all claims resulting directly or indirectly from the purchase, ownership, or use of the items.

E-Brake Cable Drill Template

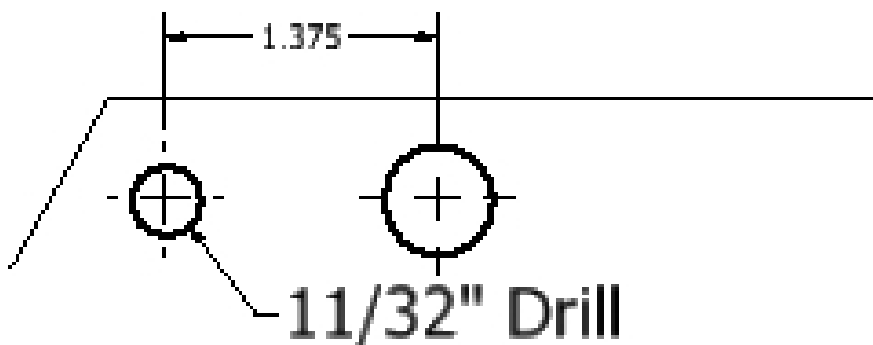

Thank you for purchasing Rough Country products.