

# ROUGH COUNTRY

## SUSPENSION SYSTEMS®



51930BAG1

## FORD 2017-18 RAPTOR 4.5" LIFT KIT

**THANK YOU FOR CHOOSING ROUGH COUNTRY FOR YOUR SUSPENSION NEEDS.**

Rough Country recommends a certified technician install this system. In addition to these instructions, professional knowledge of disassemble/reassembly procedures as well as post installation checks must be known. Attempts to install this system without this knowledge and expertise may jeopardize the integrity and/or operating safety of the vehicle.

Please read instructions before beginning installation. Check the kit hardware against the parts list. Be sure you have all needed parts and know where they go. Also please review tools needed list and make sure you have needed tools.

### PRODUCT USE INFORMATION

**▲WARNING** The taller a vehicle is, the easier it will roll. We strongly recommend, because of rollover possibility that seat belts and shoulder harnesses should be worn at all times. Avoid situations where a side rollover may occur.

**▲WARNING** Generally, braking performance and capability are decreased when larger/heavier tires and wheels are used. Take this into consideration while driving. Do not add, alter, or fabricate any factory or after-market parts to increase vehicle height over the intended height of the Rough Country product purchased. Mixing component brands is not recommended.

Rough Country makes no claims regarding lifting devices and excludes any and all implied claims. We will not be responsible for any product that is altered. If questions exist we will be happy to answer them concerning the design, function, and correct use of our products.

This 4.5" suspension system was developed using a 37X12.50/20 tire with 20 x 9 wheel with 0mm offset, slight trimming may be required. **Cannot use OEM wheels. Must use 18" or larger dia. wheels not to exceed 9" in width with 0mm offset/5" backspacing.** Due to manufacturing, dimension variances, and inflation, all tire and wheel combinations should be tested prior to installation on all oversized / wider then stock tires.

**▲NOTICE** Vehicles will require the EPAS (Electronic Power Assist Steering) plugs to be disconnected prior to beginning installation of this kit. See installation instructions. Failure to disconnect these plugs may result in damage to the EPAS module resulting in an error message being displayed, which will require replacement of the EPAS module

### ▲NOTICE DEALER AND VEHICLE OWNER

Any vehicle equipped with any Rough Country product should have a "Warning to Driver" decal installed on the inside of the windshield or on the vehicle's dash. The decal should act as a constant reminder for whoever is operating the vehicle of its unique handling characteristics.

#### Tools Needed:

5mm Allen	Floor Jack
8mm Allen	Jack stands
8mm wrench /socket	Reciprocating Saw
10mm wrench /socket	Hammer
13mm wrench / socket	1 1/16" Wrench
15mm wrench /socket	Torque wrench
18mm wrench /socket	Tape measure
21mm wrench /socket	Strut/Spring Compressor
27mm wrench /socket	Hand Vacuum Pump
30mm wrench /socket	Die Grinder
1/2" wrench/socket	Cutoff Wheel
5/8" wrench/ socket	
9/16" wrench/socket	
3/4" wrench/ socket	

#### Torque Specs:

Size	Grade 5	Grade 8
5/16"	15 ft/lbs	20 ft/lbs
3/8"	30 ft/lbs	35 ft/lbs
7/16"	45 ft/lbs	60 ft/lbs
1/2"	65 ft/lbs	90 ft/lbs
9/16"	95 ft/lbs	130 ft/lbs
5/8"	135 ft/lbs	175 ft/lbs
3/4"	185 ft/lbs	280 ft/lbs
	Class 8.8	Class 10.9
6MM	5 ft/lbs	9 ft/lbs
8MM	18ft/lbs	23 ft/lbs
10MM	32ft/lbs	45ft/lbs
12MM	55ft/lbs	75ft/lbs
14MM	85ft/lbs	120ft/lbs
16MM	130ft/lbs	165ft/lbs
18MM	170ft/lbs	240ft/lbs



## KIT CONTENTS

### 51930Box3:

1-Driver Side Knuckle

### 51930Box4:

1-Pass Side Knuckle

### 51930Box1:

1-Fr Crossmember

1-Rr Crossmember

### 51930Box2:

1-Front Diff Bracket

1-Pass Side Diff Brace Bracket

1-Dr Side Sway Bar Bracket

1-Pass Side Sway Bar Bracket

2-Fr Brake Line Brackets

1-Front Lower Skid Plate

1-Rear E-Brake Bracket

1-Front Driveshaft Spacer

1-1557Bag8

1-51930BAG2

1-51930Bag1

1-1557Bag15

1-Front Pass Diff Bracket

1-Dr Rear Diff Mount

2-Cable Ties

1-1500

### 51930Box5:

2-Rear Blocks

2-Rear Shocks Brackets

2-LH Lower Strut Clamps

2-RH Lower Strut Clamps

4-Strut Bushing Block Offs

2-Lower Strut Extensions

1-1263Bag2

1-9/16Bag

4-9/16" x 3" x 11" Ubolts

1-10mmStudBag

1-51930Bag3

1-51930Bag4

1-Rear Brake Line Bracket

### 1557Bag8 Containing:

**For Fr Dr Side Upper Diff Mount:**

1-9/16" x 4" Bolt

2-9/16" Flat Washers

1-9/16" Lock Nut

1-1/2" x 1.5" Bolt

1-1/2" Nylock Nut

2-1/2" Flat Washer

### 1557Bag8 Continued:

**For Fr Dr Side Lower Diff Mount:**

1-9/16" x 4" bolt

2-9/16" Flat Washers

1-9/16" Lock Nut

**For Fr / Rr Crossmember:**

2-18mm x 150mm Bolts

4-3/4" Flat Washers

2-18mm Lock Nuts

**For Fr Pass Side Diff Mount:**

1-9/16" x 4" Bolt

2-9/16" Flat Washers

1-9/16" Lock Nut

### 1500 Containing:

**For Lower Control Arms:**

4-18mm x 160mm Cam Bolts

4-Flat Washers

4-18mm Lock Nuts

### 1557Bag15 Containing:

**For Pass Diff Brace:**

2-12mm x 35mm

2-12mm Lock Nut

4-Flat Washers

### 51930BAG2 Containing:

**For Front Skid Plate:**

4-3/8" x 1" Bolt

4-3/8" Flat Washers

**For Front Driveshaft:**

6-10mm x 85mm Allen Bolts

**For Front Brake Line Bracket:**

2-5/16" x 3/4" Bolt

2-5/16" Flat Washer

2-5/16" Lock Nut

**For Sway Bar Brackets:**

4-7/16" x 1.25" Bolts

8-7/16" Flat Washers

4-Lock Nuts

**For Diff Tube:**

1-Diff Tube Ext.

1-Tube Coupler

### 10mmStudBag Containing:

**For Front Strut Spacers:**

6-10mm Studs

6-10mm Lock Washer

7-10mm Hex Nuts

1-1/2" Jam Nut

6-3/8" Flat Washers

### 9/16Bag:

**For Rear Blocks:**

8-9/16" Nuts

8-9/16" Flat Washers

### 1263Bag2:

**For Rear Brake Line Brckt:**

4-7/16" UBolts

8-7/16" Nylock Nuts

8-7/16" Flat Washers

### 51930Bag3:

**For Rear Blocks:**

1-5/16" x 3/4" Bolt

1-5/16" Washer

1-5/16" Flange Lock Nut

**For Rear Shock Brackets:**

2-12mm x 75mm Bolts

6-1/2" Flat Washers

2-Square Washers

2-1/2" x 1.5" Bolts

2-1/2" Nylock Nuts

### 51930Bag4:

**For Strut Clamps:**

4-1/2" x 4" Bolts

8-1/2" Flat Washers

4-1/2" Nuts

6-3/8" x 1.5" Bolts

12-3/8" Flat Washers

6-3/8" Nylock Nuts



## INSTALLATION INSTRUCTIONS

1. Chock the rear wheels and jack up the front of the vehicle.
2. Place jack stands under the frame rails and lower onto jack stands.
3. Remove the wheels/tires using a 21mm socket.
4. Remove the rear lower skid plate using a 10mm socket on the front 2 bolts and a 13mm socket on the 4 side bolts.  
**See Photos 1 & 2.**

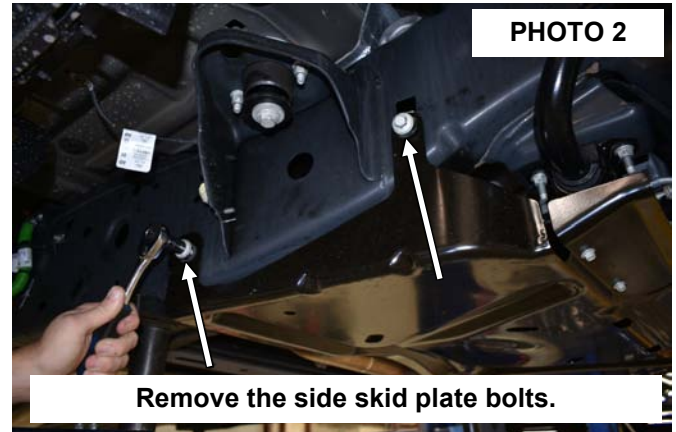

5. Remove the front skid plate and skid brace using a 13mm socket on the 4 front bolts and a 15mm socket on the 2 rear bolts. **See Photos 3 & 4.**



6. Remove the center skid plate using a 13mm socket. **See Photo 5.**
7. Disconnect the 2 wiring harnesses going to the rack and pinion. **See Photo 6.**





8. Using pliers, remove the axle nut dust cap.
9. Using a 13mm socket, remove the axle nut. **Do not use an impact. See Photo 7.**
10. Using a 21mm wrench, loosen the tie rod end nut. Strike the knuckle, at the tie rod end, to release the taper. Remove the tie rod end nut and retain for reuse. **See Photo 8.**

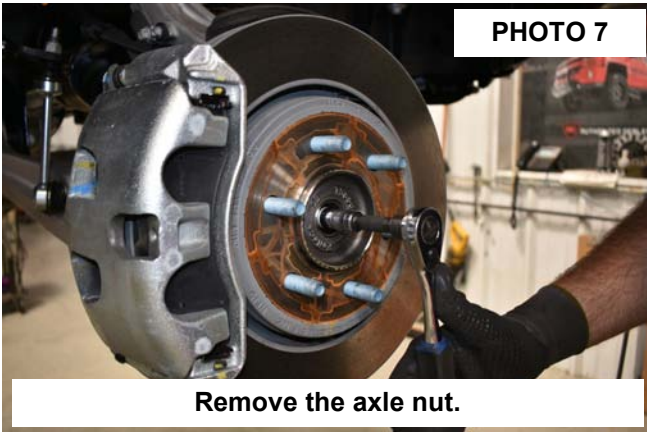

**PHOTO 7**

**Remove the axle nut.**

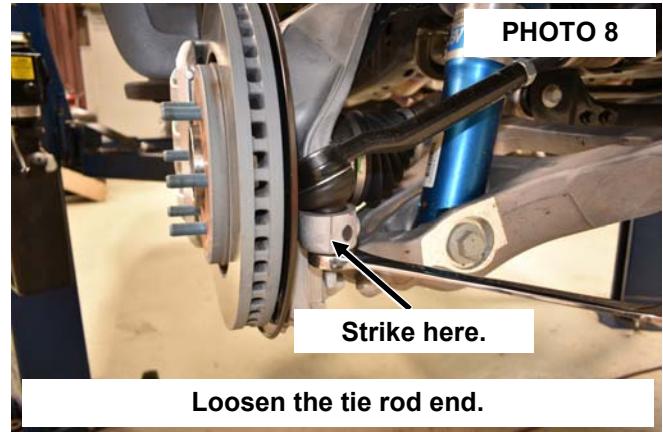

**PHOTO 8**

Strike here.

**Loosen the tie rod end.**

11. Remove the ABS and brake line bracket from the knuckle using a 8mm wrench for the ABS wire and a 10mm wrench for the brake line bracket. Retain hardware for reuse. **See Photo 9.**
12. Remove the vacuum lines from the hub. **See Photo 10.**



**PHOTO 9**

**Remove the brake line/ABS bracket.**

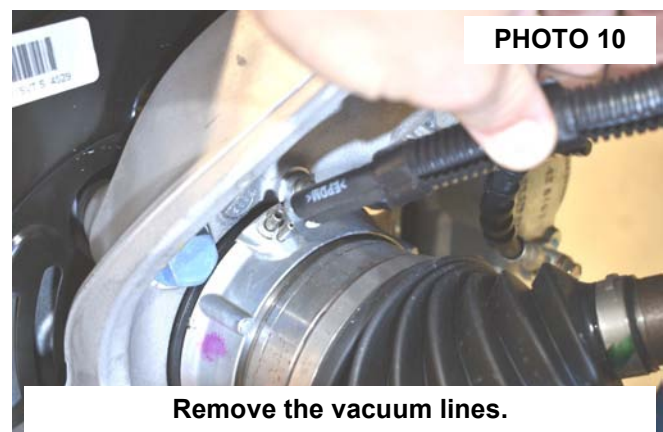

**PHOTO 10**

**Remove the vacuum lines.**

13. Using a 21mm socket, remove the brake caliper. Hang caliper out of way. **Do not let caliper hang by brake hose as this will damage hose.** Retain hardware for reuse. Remove rotor. **See Photo 11.**
14. Remove the brake rotor. **See Photo 12.**

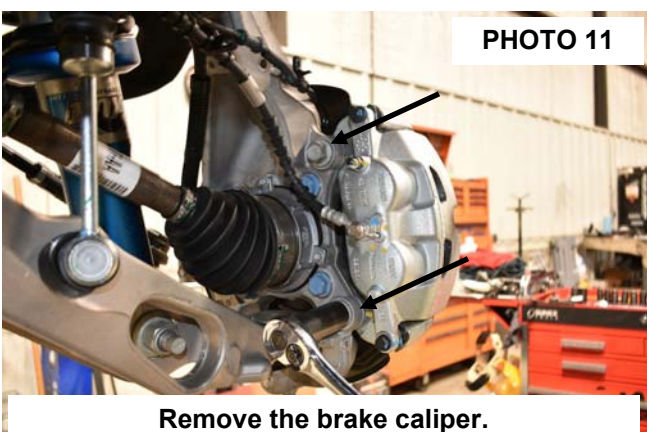

**PHOTO 11**

**Remove the brake caliper.**

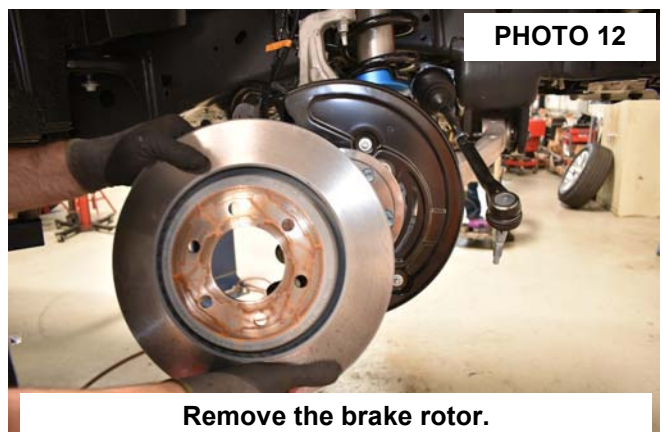
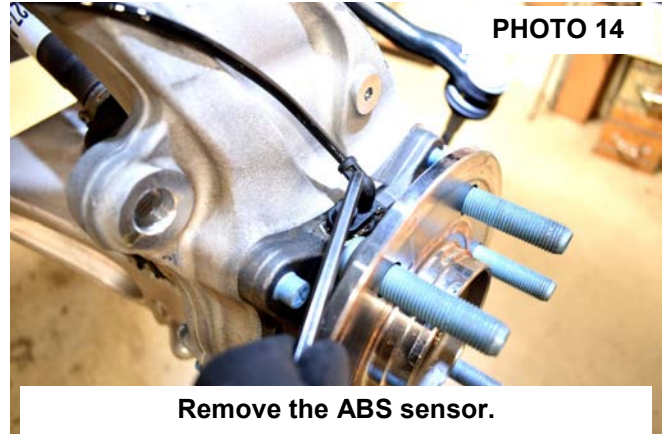
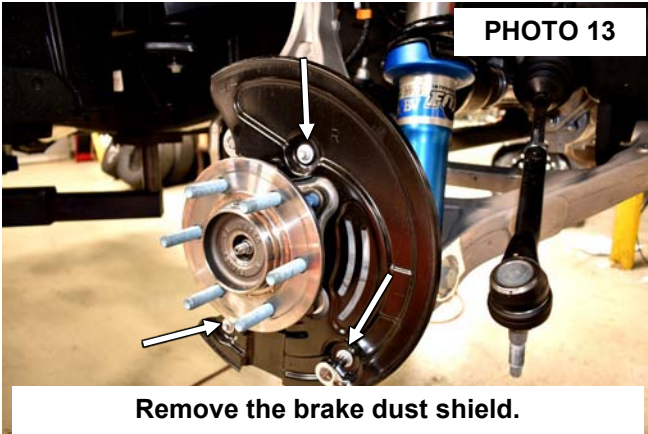

**PHOTO 12**

**Remove the brake rotor.**

15. Using an 8mm socket, remove the dust shield from the knuckle. Retain hardware. **See Photo 13.**

16. Using a 5mm Allen, remove the ABS sensor. **See Photo 14.**



17. Using an 18mm and 8mm wrench, **loosen** the upper ball joint nut. Strike the knuckle, at the upper ball joint, with a hammer to release the taper of the ball joint. Remove the nut and retain for reuse. **See Photo 15.**

18. Using a 21mm, **loosen** the lower ball joint nut. Strike the knuckle, at the lower ball joint, with a hammer to release the taper of the ball joint. Remove the nut and retain for reuse. **See Photo 16.**

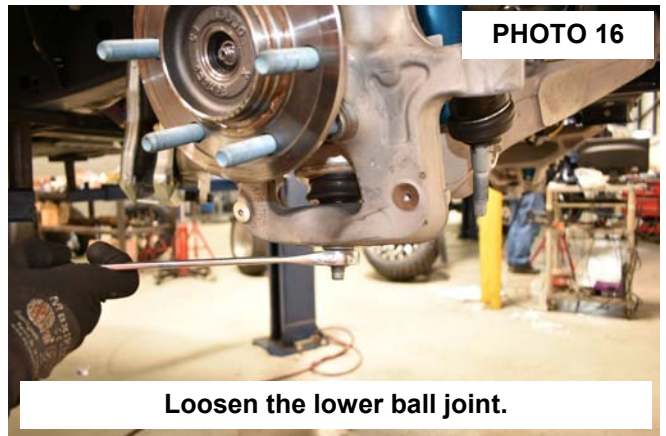

19. Remove the knuckle from the upper and lower ball joints. **See Photo 17.**

20. Remove the sway bar links from the sway bar using an 18mm wrench. Retain hardware for reuse. **See Photo 18.**





21. Using a 30mm socket and 27mm wrench, remove the lower strut hardware. Retain hardware. **See Photo 19.**  
22. Using 21mm and 27mm loosen the lower control arm bolts. **See Photo 20.**

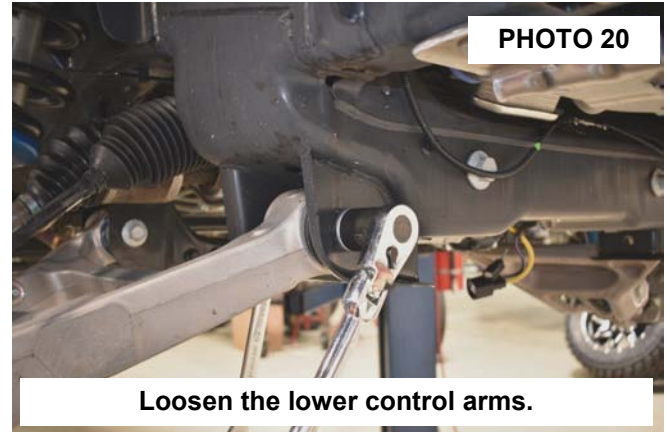

23. Using an 18mm wrench, remove the upper strut hardware. Retain for reuse. **See Photo 21.**  
24. Remove the strut. **See Photo 22.**

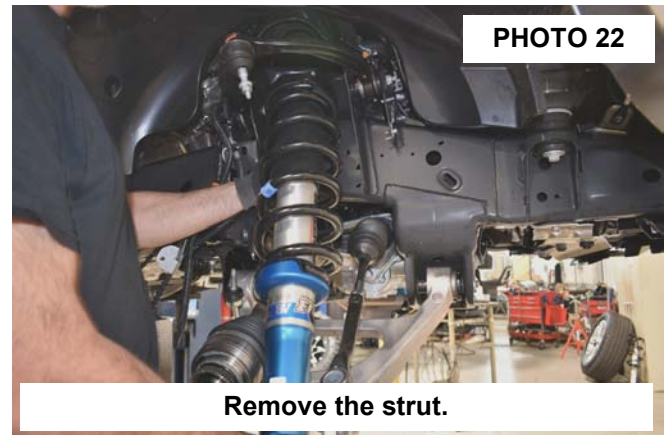
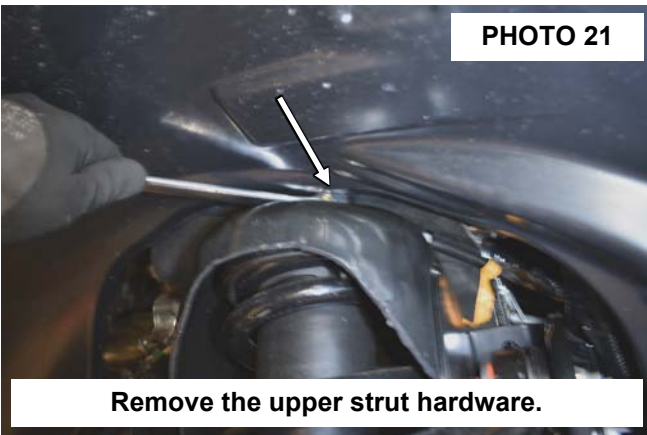

25. Remove the lower control arm. Retain hardware. **See Photo 23.**  
26. Using a 15mm socket, remove the sway bar from the frame brackets. **See Photo 24.**



27. Using 15mm and 18mm wrenches, remove the factory rear cross member. **See Photo 25.**  
 28. Using a 10mm socket, remove the drive shaft from the front differential. Retain hardware. **Support driveshaft, do not let the driveshaft hang from the rear rzeppa joint as damage can occur. See Photo 26.**



**Remove the rear crossmember.**

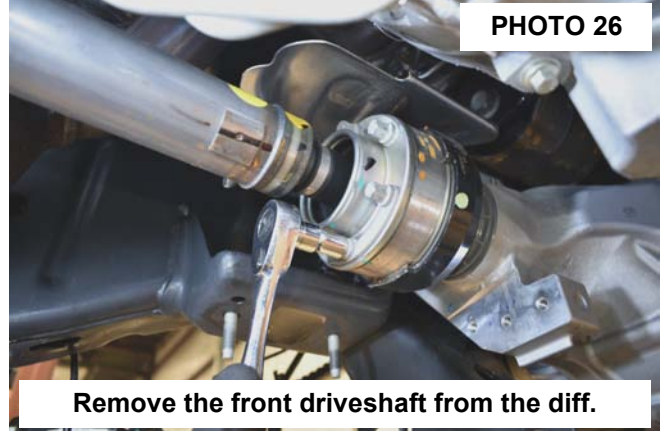

**Remove the front driveshaft from the diff.**

29. Support the front differential using a jack.  
 30. Remove the differential vent tube from the differential.  
 31. Remove the driver side rear differential bolt using an 18mm socket. Retain hardware. **See Photo 27.**  
 32. Remove the driver side front differential bolt using an 18mm socket. Retain hardware. **See Photo 28.**



**Remove the dr rear diff bolt.**

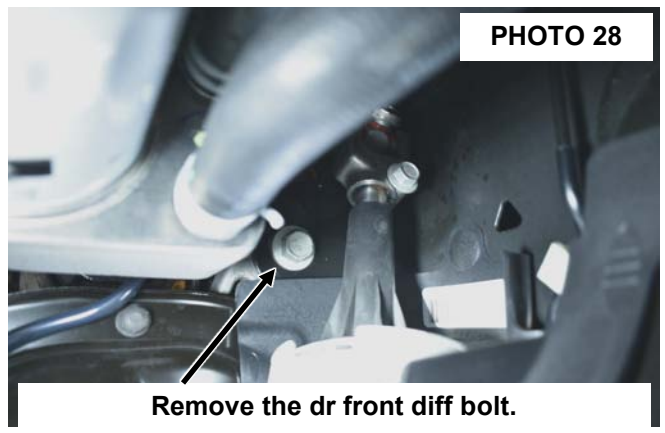

**Remove the dr front diff bolt.**

33. Remove the passenger side differential bolt using a 21mm socket. Retain hardware. **See Photo 29.**  
 34. Lower the differential from the vehicle.  
 35. On the front side of the driver rear crossmember bracket, measure over 2-3/4", from the control arm pocket, and mark. **See Photo 30.**



**Remove the pass diff bolt.**



**Measure 2-3/4" and mark.**



36. On the rear side of the driver rear crossmember bracket, measure over 2-3/4", from the control arm pocket, and mark. **See Photo 31.**
37. Using a reciprocating saw, cut along the marks made in the previous steps. This will leave the control arm pocket and holes. Sand and paint cut edges to prevent rust. **See Photo 32.**



**Measure 2-3/4" and mark.**

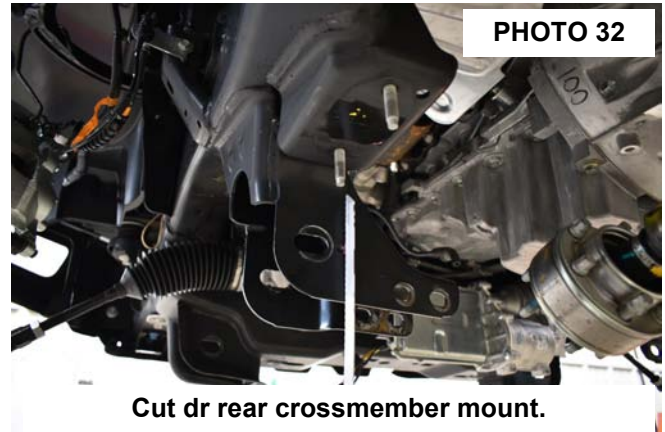

**Cut dr rear crossmember mount.**

38. Install the supplied differential drop brackets on the factory differential using the supplied 9/16" x 4" bolts, washers, and nylock nuts (1557BAG8). Do not tighten at this time. **See Photo 33.**
39. Install the differential assembly using the factory hardware. Do not tighten. **See Photo 34.**

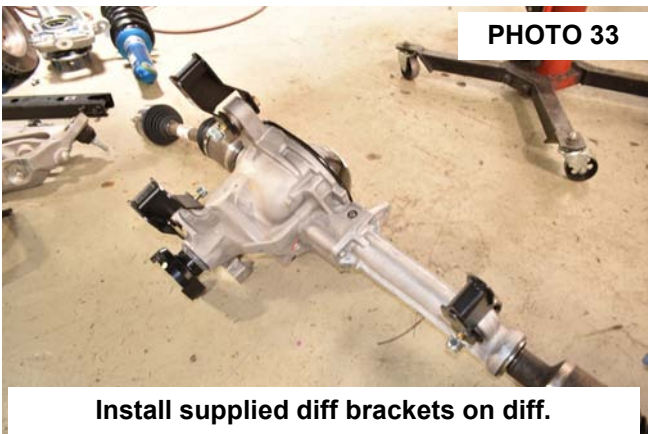

**Install supplied diff brackets on diff.**

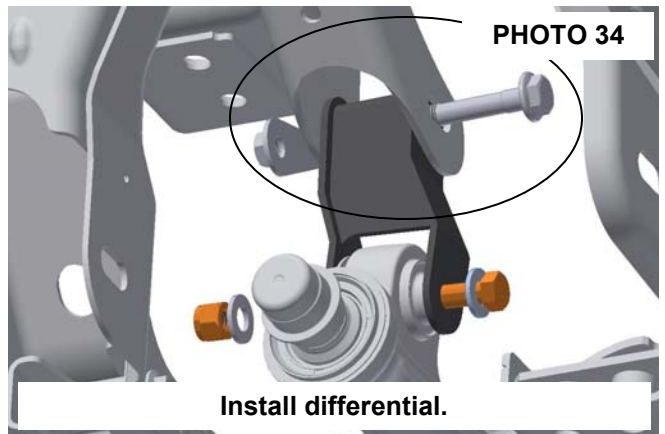

**Install differential.**

40. Install the sway bar drop brackets using factory hardware. **Do not tighten at this time.**
41. Install the rear cross-member with the supplied 18mm x150mm bolt. The bolt will install through the sway bar bracket and rear cross-member, securing it to the stock location. Do not tighten at this time. **See Photo 35.**
42. Install the passenger side differential brace as shown in **Photo 36** using the supplied 12mm hardware in 1557BAG15. **Do not tighten at this time.**

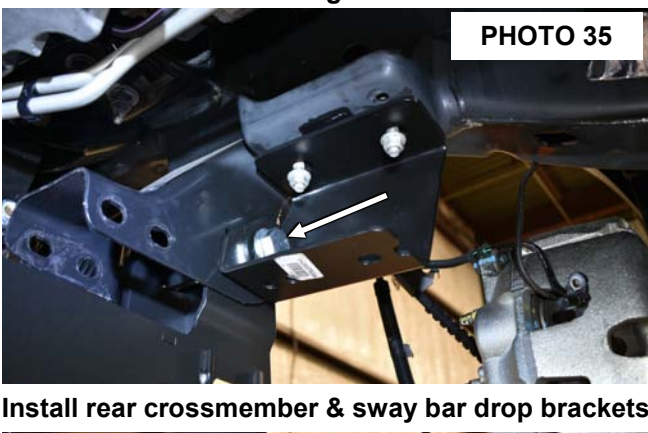

**Install rear crossmember & sway bar drop brackets.**

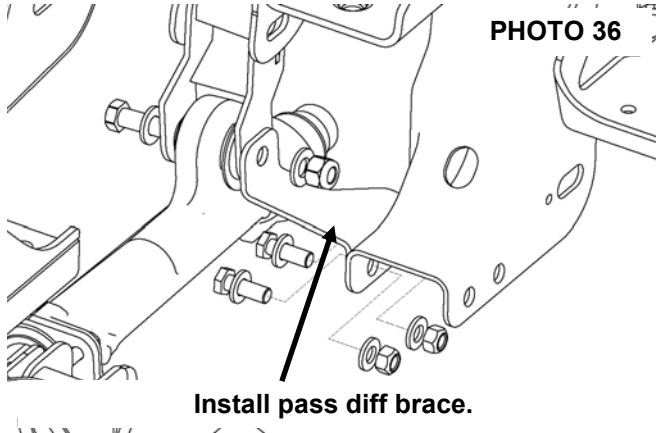

**Install pass diff brace.**



43. Attach the rear diff mount to the cross member using the supplied 1/2" hardware. Attach to upper mount using factory hardware. **See Photo 37.**
44. At this time tighten all diff bolts using 18mm socket / wrench for the upper diff bolts and a 21mm & 22mm socket / wrench for the new supplied lower diff bolts. Also tighten the passenger side diff brace hardware using a 19mm & 18mm socket /wrench.
45. Reinstall the vent tube on the differential with the new supplied vent tube extension 51930BAG2.
46. Install the front cross-member using the factory hardware. Do not tighten at this time. **See Photo 38.**

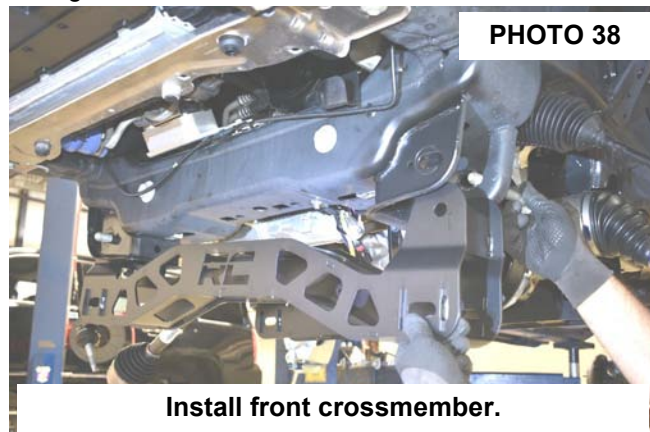
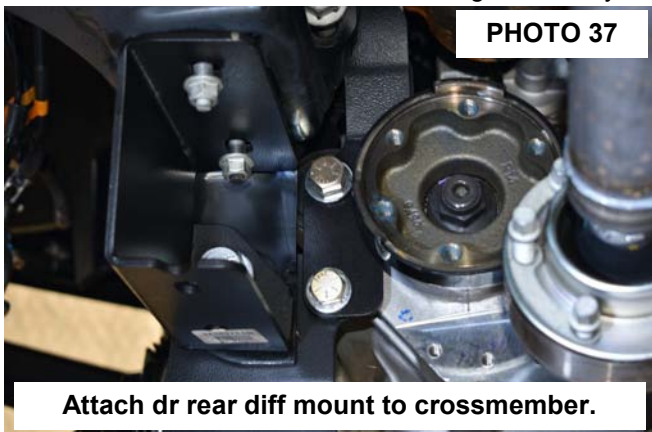

47. Install the lower control arms using the supplied 18mm x 160mm cam bolts, washers and nuts. Do not tighten at this time. **See Photo 39.**
48. Tighten all upper cross-member bolts using a 21mm, 1 1/16" socket and 1 1/16" wrench. Torque to factory specs. **See Photos 40 & 41.**

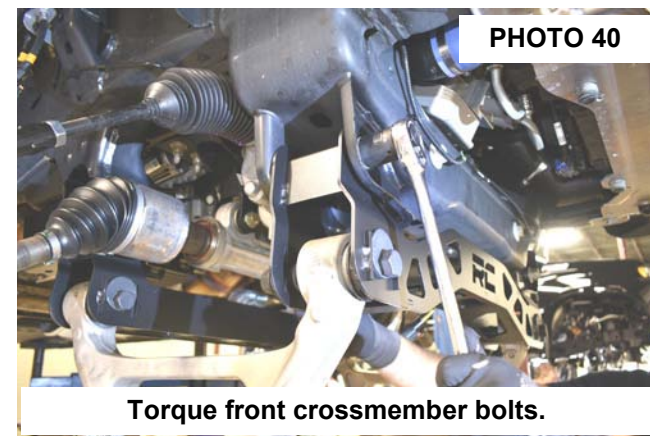
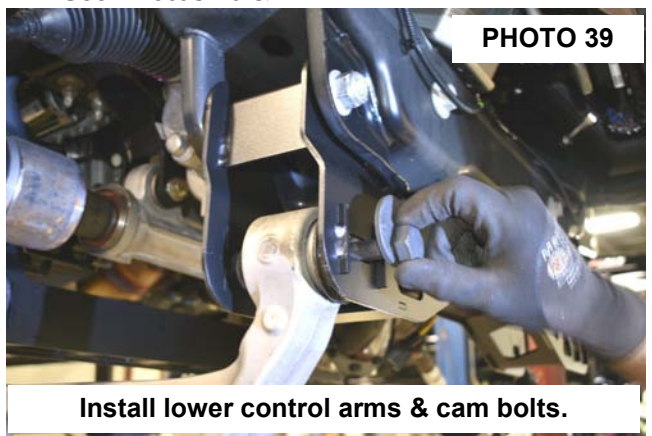

49. Tighten the sway bar drop mounts to the frame using the factory hardware with a 15mm socket. Torque to factory specs. **See Photo 42.**

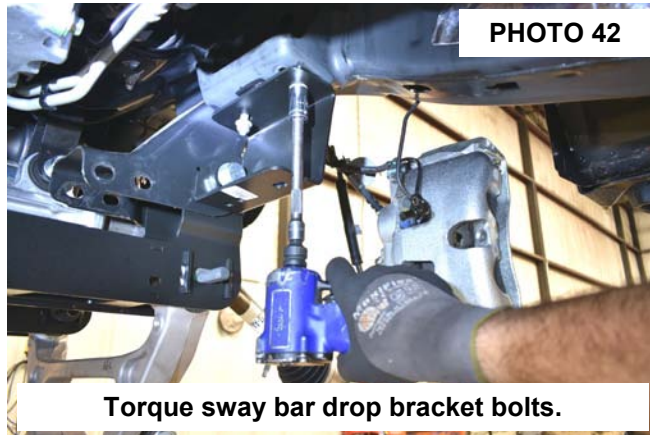
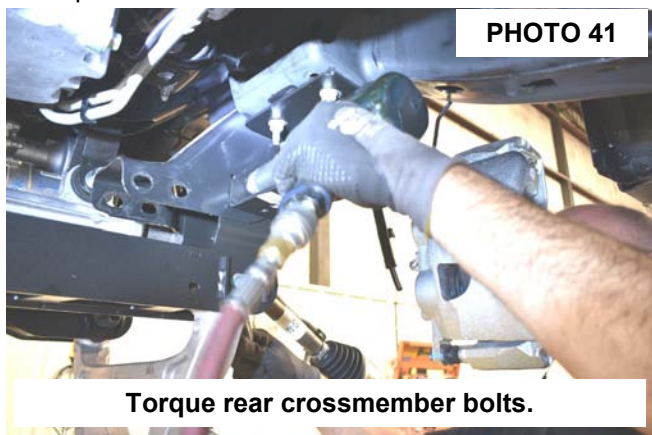

50. Torque the rear diff mount to crossmember bolt using a 3/4" socket and wrench to 65ft/lbs. **See Photo 43.**
51. Install the drive shaft spacer with supplied 10mm x 85mm hardware (51930BAG2). Place a thread locker on the bolt threads. **See Photo 44.**

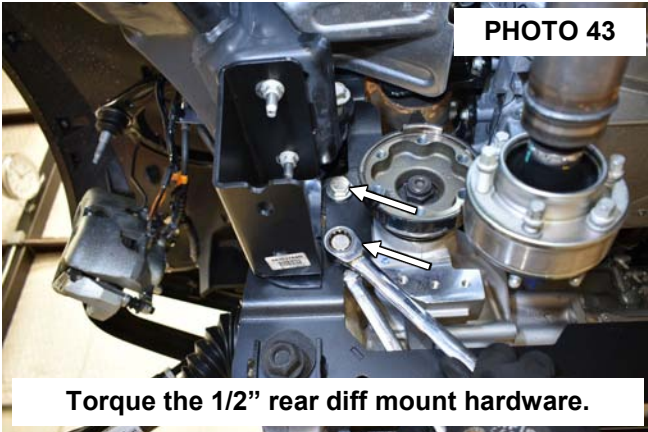

**Torque the 1/2" rear diff mount hardware.**

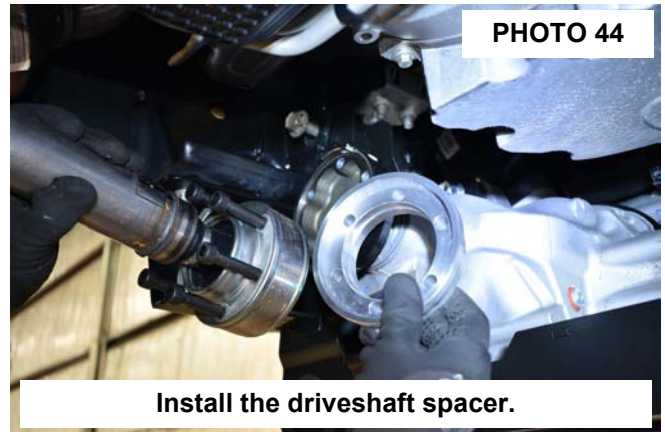

**Install the driveshaft spacer.**

52. Tighten using a 8mm allen wrench. Torque to 64ft/lbs. **See Photo 45.**
53. Using a 10mm socket, remove the brake line bracket from the frame. Retain hardware. **See Photo 46.**

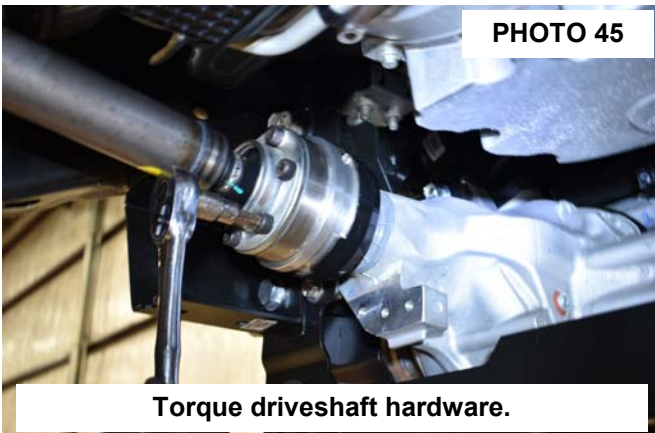

**Torque driveshaft hardware.**

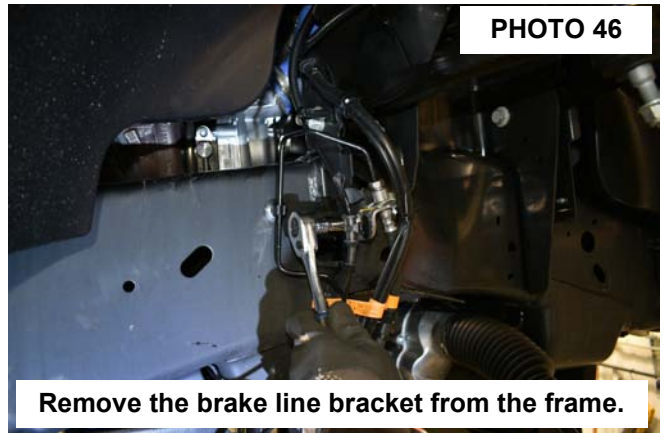

**Remove the brake line bracket from the frame.**

54. Install the supplied brake line relocation bracket in the factory location using the factory hardware. Attach the factory brake line bracket to the supplied relocation bracket using the supplied 5/16" x 3/4" bolts, washers, and nuts (51930BAG2). Tighten the factory hardware using a 10mm socket and the supplied hardware using a 1/2" socket and wrench. **See Photo 47.**
55. Mark the strut hat and spring. Place the strut in a spring compressor and compress the spring. Rotate the **strut hat only, 90° clockwise**. Release the spring compressor and remove the strut. **See Photo 48.**

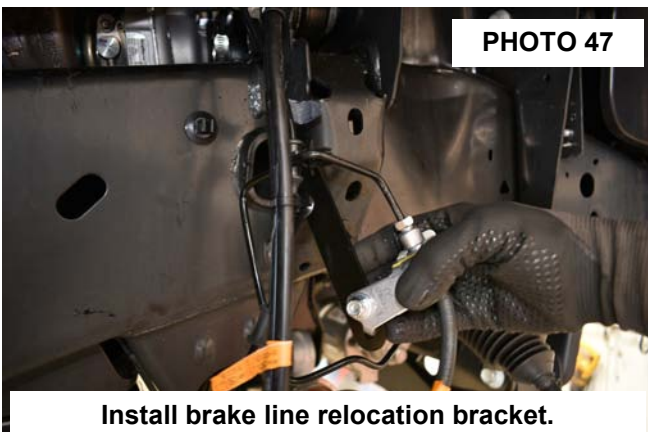

**Install brake line relocation bracket.**

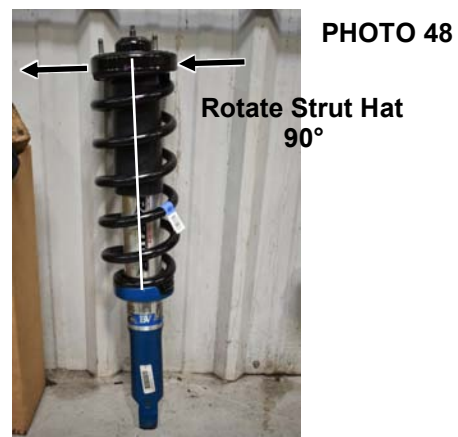

**Rotate Strut Hat 90°**



- 56. Press the lower strut bushing out of the strut.
- 57. Install the strut in the upper strut mount using the factory hardware. Do not tighten at this time.
- 58. Install the (2) supplied lower strut aluminum block off halves in the lower strut mount. **See Photo 49.**
- 59. Slide the lower strut extension over the lower strut mount. **See Photo 50.**

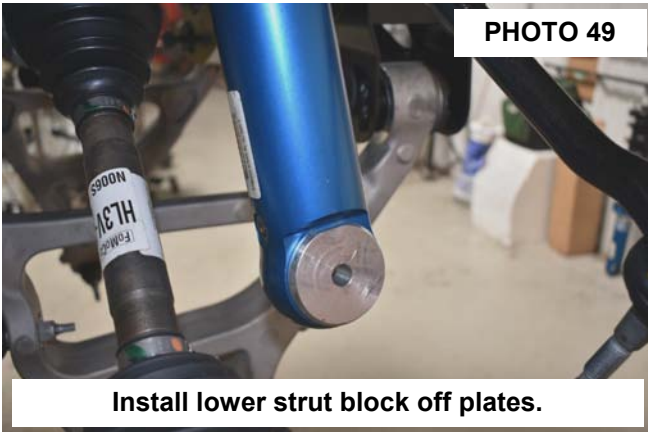

**PHOTO 49**

**Install lower strut block off plates.**



**PHOTO 50**

**Install lower strut mount.**

- 60. Install the lower strut clamps on the lower strut mount, using the supplied 1/2" x 4" bolts, washers and nuts (51930BAG4). Do not tighten. **See Photo 51.**
- 61. Attach the clamps together using the supplied 3/8" x 1.5" bolts, washers, and nuts (51930BAG4). Torque to 35ft/lbs using a 9/16" wrench and socket. **See Photo 52.**



**PHOTO 51**

**Install strut clamps.**

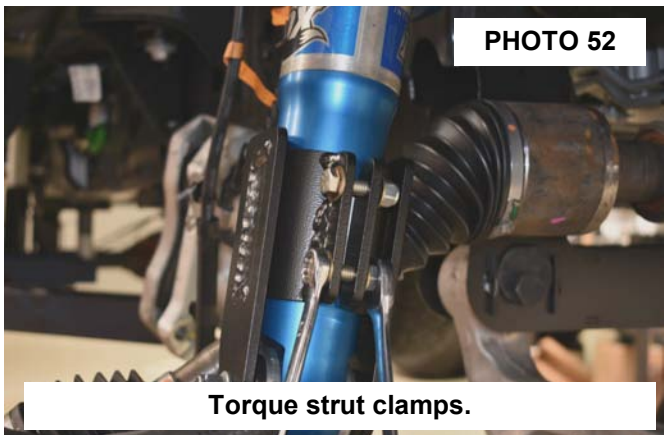

**PHOTO 52**

**Torque strut clamps.**

- 62. Torque the 1/2" bolts to 90ft/lbs using a 3/4" socket and wrench. **See Photos 53 & 54.**

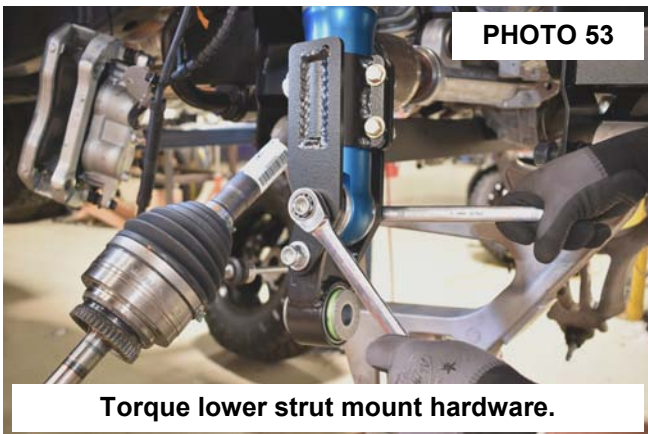

**PHOTO 53**

**Torque lower strut mount hardware.**

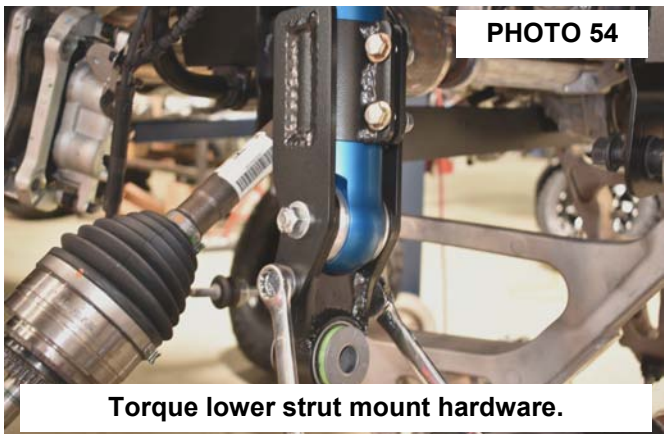
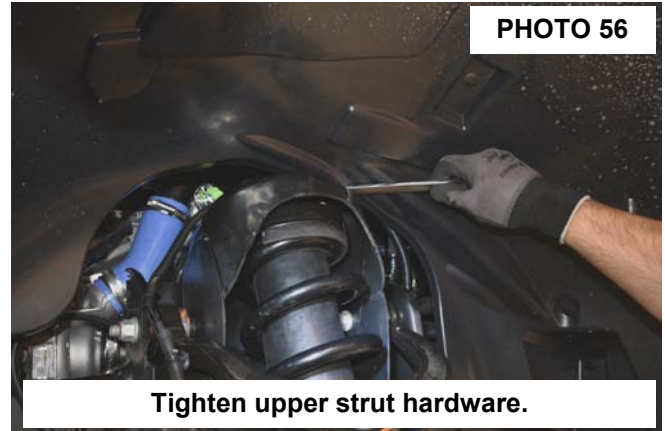
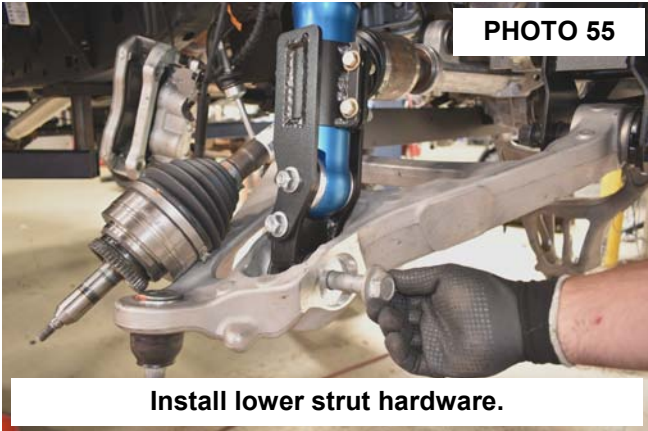

**PHOTO 54**

**Torque lower strut mount hardware.**

63. Install the strut in the lower control arm using the factory lower mounting hardware. Torque to factory specs using a 30mm socket, and 27mm wrench. **See Photo 55.**

64. Tighten the upper strut hardware using a 18mm wrench. **See Photo 56.**



65. Carefully remove the hub locking mechanism using an 8mm socket. Retain hardware. **See Photo 57.**

66. Using an 18mm socket, remove the hub bolts from the factory knuckle. **See Photo 58.**

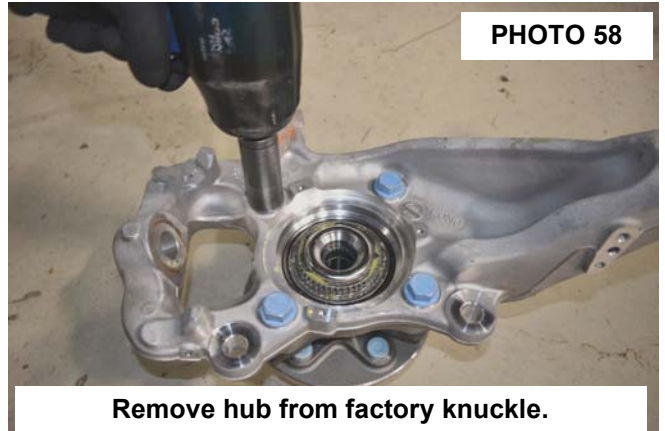
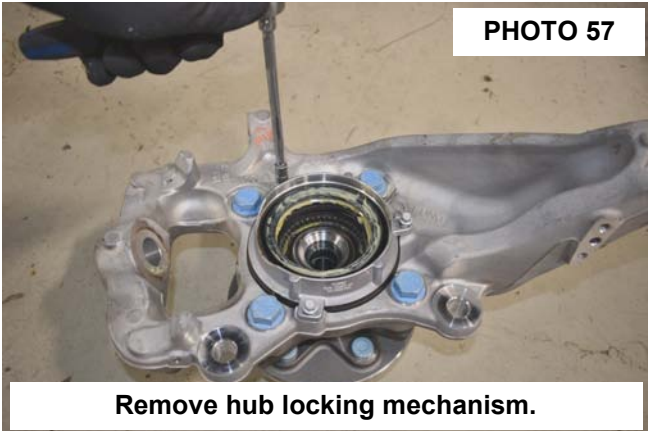

67. Remove the hub bearing assembly from the knuckle. **See Photo 59.**

68. Install the hub bearing assembly into the supplied lift knuckle using the factory hardware. Torque to factory specs using an 18mm socket. **See Photo 60.**

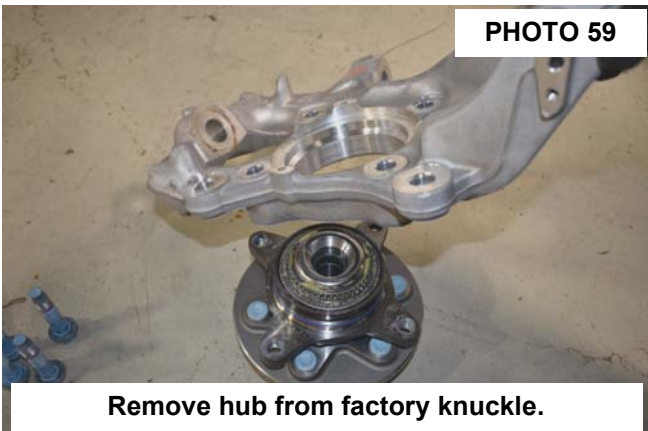



**▲ NOTICE** We recommend using OE instructions for disassembly and assembly of IWE actuator, the following instructions are for reference only.

68. Install IWE actuator on CV shaft.

**▲ NOTICE** Make sure the actuator splines line up to the splines on the CV shaft. See photo 66.

69. Install CV shaft into the knuckle assembly. See Photo 67.



70. Using a floor jack, raise the lower control arm and connect the upper ball joint on the upper control arm to the spindle. Using a 21mm wrench, torque to manufacturer specs. If ball joint turns while tightening, use a 3/8" wrench to hold the ball joint.

71. Reinstall the steering linkage nut using a 21mm wrench.

72. Using a hand vacuum pump, apply and hold 24inHG of vacuum to the actuator through the large port. See Photos 68 and 69.



73. Install the (3) bolts securing the actuator to the knuckle and tighten using an 8mm wrench. **See Photo 70.**

74. **▲ NOTICE** With vacuum still applied to actuator. Measure the depth of the CV shaft treads protruding through the hub bearing. If **minimum 15.5mm or .61"** is not achieved, rotate the hub to eliminate binding of the splines. **See Photo 71.**

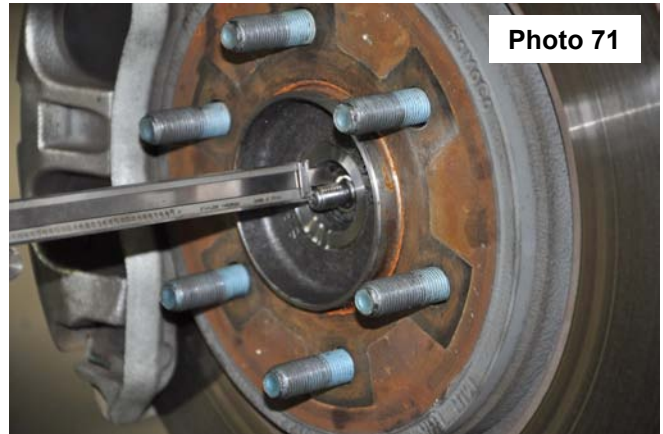
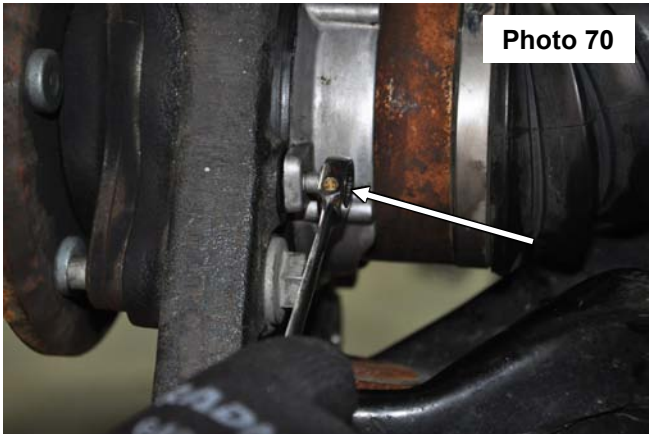

75. Install axle nut and tighten to 30 lb.ft. **▲ NOTICE** Do Not Use an impact, caution must be taken or damage to shaft may occur. **See Photo 72.**

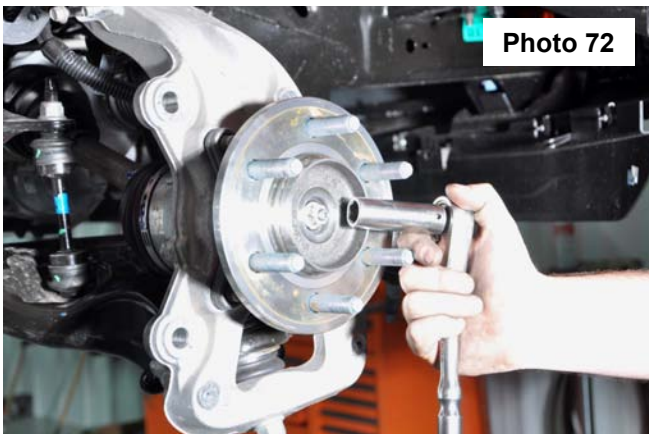

76. Verify free rotation of the hub with **NO** CV shaft rotation. No clicking or grinding noise should be present

77. Release the vacuum from the actuator and rotate the hub to engage the actuator. You may hear/feel the actuator engage.

78. Verify that the hub and CV rotate together. Reconnect the vacuum lines to the actuator. **See Photo 73.**

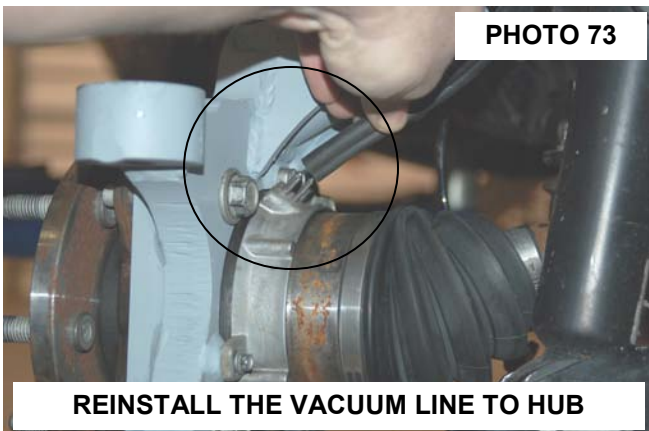



79. Install the ABS wire on the bearing assembly using a 5mm allen wrench. **See Photo 74.**

80. Install the rotor and caliper on the knuckle with the stock hardware using a 21mm socket. Tighten hardware. **See Photo 75.**

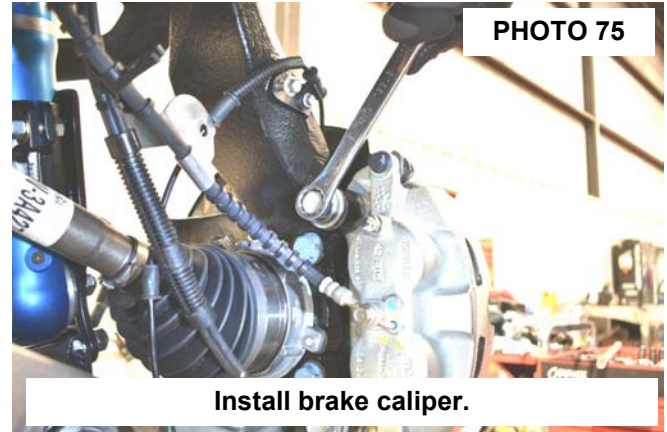
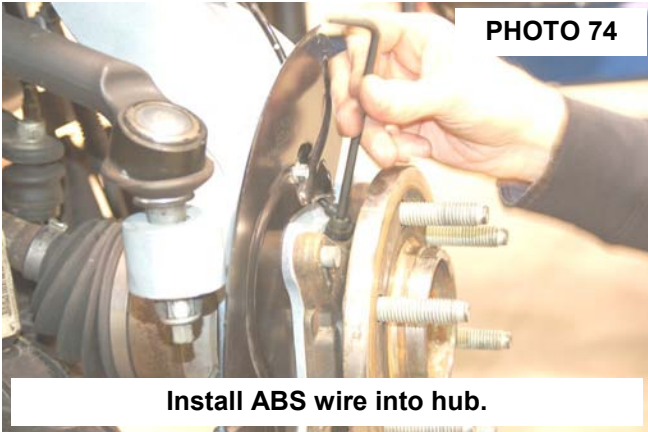

81. Install the sway bar on the drop brackets using the supplied 7/16" x 1.25" bolts, nuts, and washers (51930BAG2). Torque to 45ft/bs using a 5/8" socket and wrench. **See Photo 76.**

82. Attach the sway bar to the factory sway links and tighten using an 18mm wrench. **See Photo 77.**

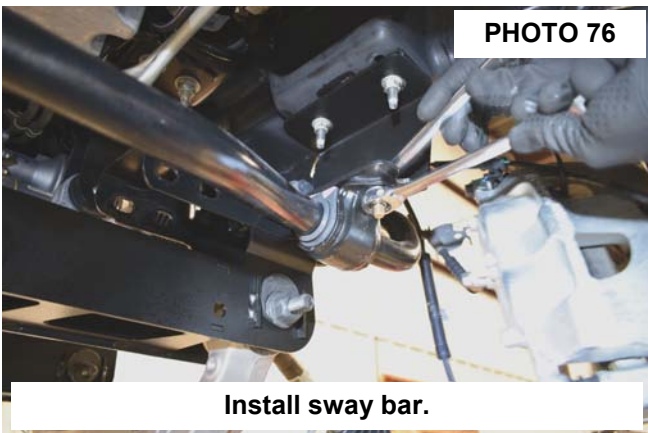

83. Attach the brake line and ABS line to the knuckle using the factory hardware. Tighten using a 10mm and 8mm socket. **See Photo 78.**

84. Install the tie rod end into the knuckle using the factory hardware. Tighten using a 21mm wrench. **See Photo 79.**

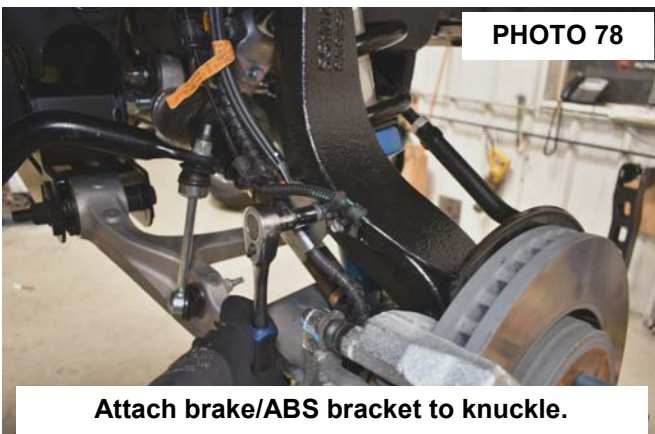

85. Install the supplied skid plate using the supplied 3/8" x 1" bolts and washers (51930BAG2). Torque to 30ft/lbs using a 9/16" socket.
86. In steps 87-89 you will be trimming the front skid plate to clear the new dropped front crossmember.
87. From the center of the front bolt hole, on the front skid plate, measure 2-7/8" and mark. **See Photo 80.**
88. Using a cutoff wheel, cut from the front corner of the skid plate to the mark made in step 85. **See Photo 81.**



**PHOTO 80**

**Measure 2-7/8" and mark.**

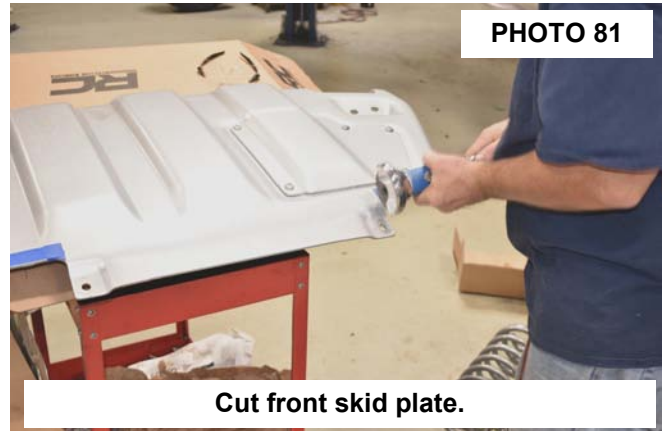

**PHOTO 81**

**Cut front skid plate.**

89. Cut from the outer edge of the skid plate to the mark made in step 85. **See Photo 82.**
90. Sand the cut edges smooth. **See Photo 83.**



**PHOTO 82**

**Cut front skid plate.**

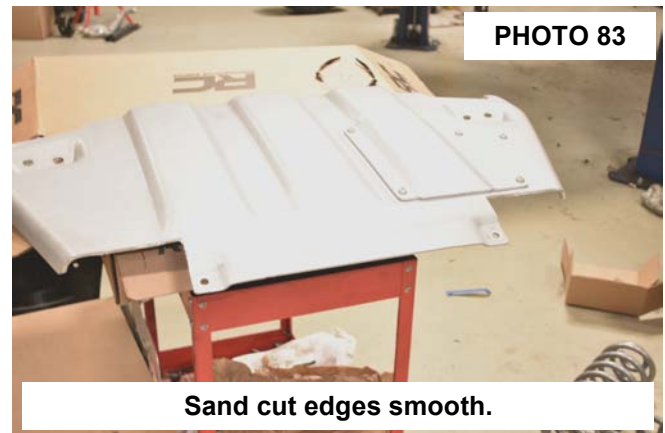

**PHOTO 83**

**Sand cut edges smooth.**

91. Install the skid plate and skid plate brace using the factory hardware. Tighten using a 15mm socket on the 2 rear bolts and a 13mm socket on the 4 front bolts. **See Photo 85.**
92. Install the tires and wheels using a 21mm socket. Remove the jack stands and lower the truck to the ground.
93. Tighten the lower control arm bolts using a 1-1/16" wrench and socket. **Torque to 240 ft/lbs.**



**PHOTO 85**

**Install front skid plate.**



## REAR INSTALLATION

1. Chock the front tires and jack the rear the rear end up. Put jack stand under the frame rail and lower truck onto jack stands.
2. Remove tires and wheels using a 21mm socket.
3. Support the rear differential with a jack.
4. Using a 10mm socket, remove the e-brake cable mount from the frame. Retain hardware. **See Photo 1.**
5. Install the supplied e-brake drop bracket using the factory hardware. Tighten using a 10mm wrench. **See Photo 2.**

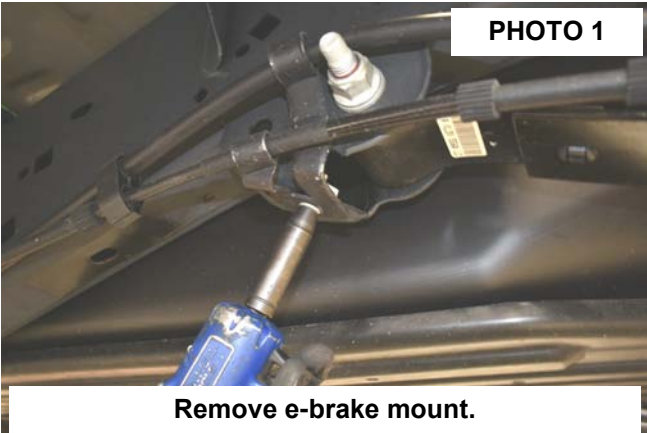

6. Attach the e-brake bracket to the drop bracket using the supplied 5/16" x 3/4" bolt, washer, and nut (51930BAG3). Tighten using 1/2" wrenches. **See Photo 3.**
7. Using a 15mm wrench and an 18mm socket, remove the lower shock hardware. Retain hardware. **See Photo 4.**

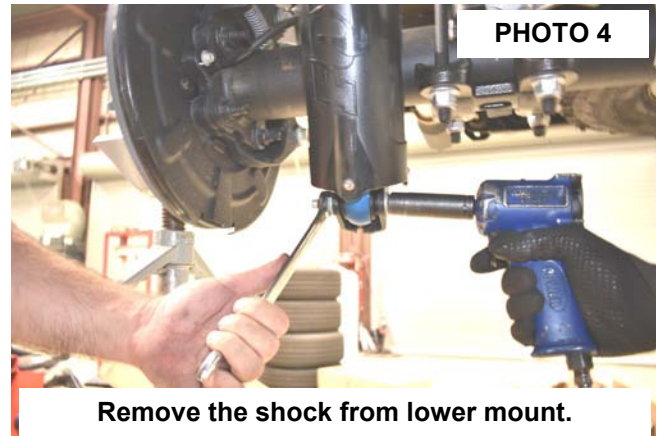
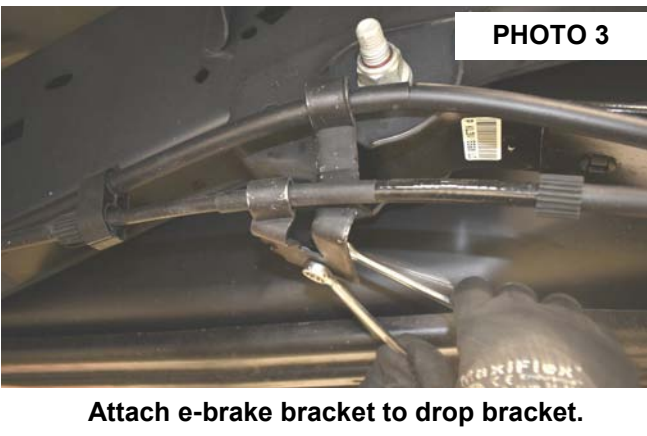

8. Using a 10mm wrench, remove the brake line bracket from the rear differential. **See Photo 5.**
9. Using a 21mm deep well socket, remove the factory u-bolts and lower the axle to remove the blocks. **See Photo 6.**

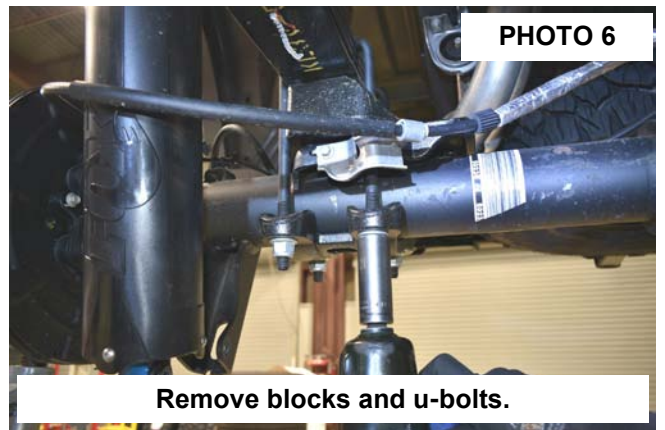
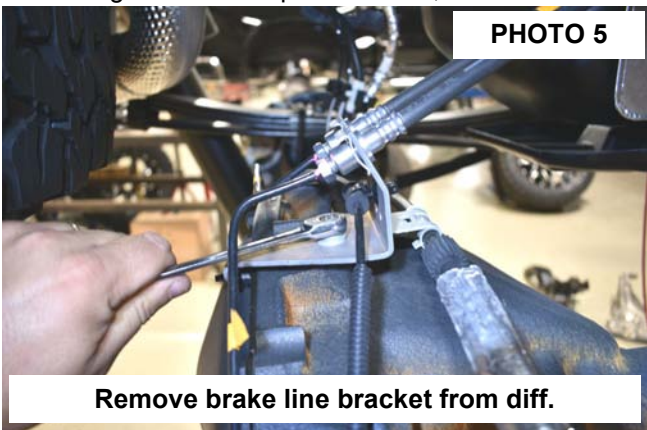

10. Using side cutters, remove the retaining washer from the brake line bracket bolt and remove the bolt from the bracket. Retain hardware. **See Photo 7.**
11. Install the supplied brake line relocation bracket between the differential and the factory brake line bracket. **See Photo 8.**

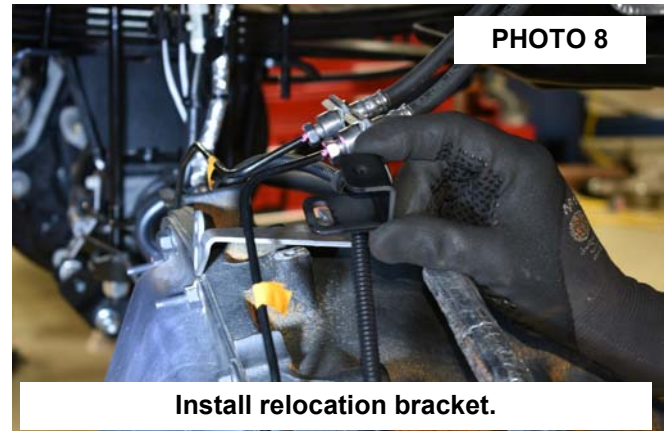

12. Attach the supplied relocation bracket to the differential using the factory hardware. Tighten using a 10mm wrench. **See Photo 9.**
13. Attach the factory brake line bracket to the relocation bracket using the supplied 5/16" x 3/4" bolt, washer, and nut (51930BAG3). Tighten using 1/2" wrenches. **See Photo 10.**

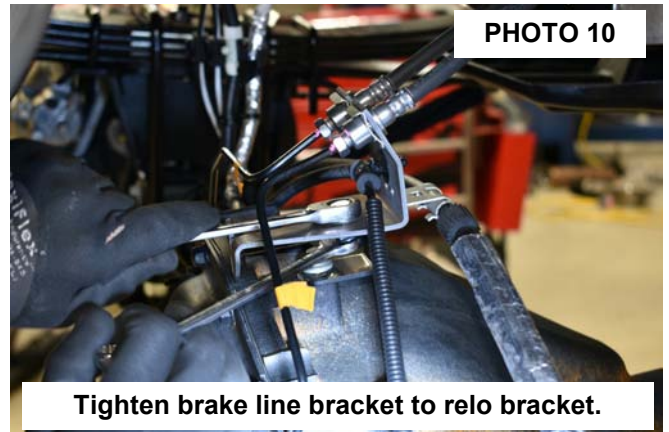
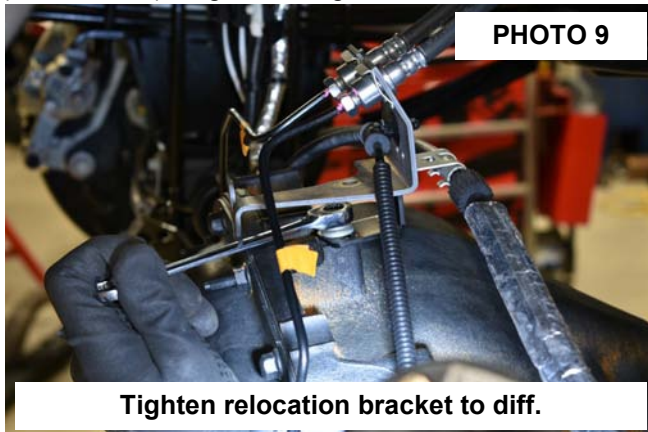

14. Install the supplied blocks on the block pin holes on the axle and raise the axle into place. **Note- Taller end of block to the rear of the truck and the bump stop flange will go to the inside!**
15. Install the axle u-bolts and tighten using a 13/16" deep well socket. **See Photo 11.**
16. Install the upper leaf spring u-bolts over the leaf spring and into the blocks. Secure with supplied hardware and tighten using a 5/8" deep well socket. **See Photo 12.**

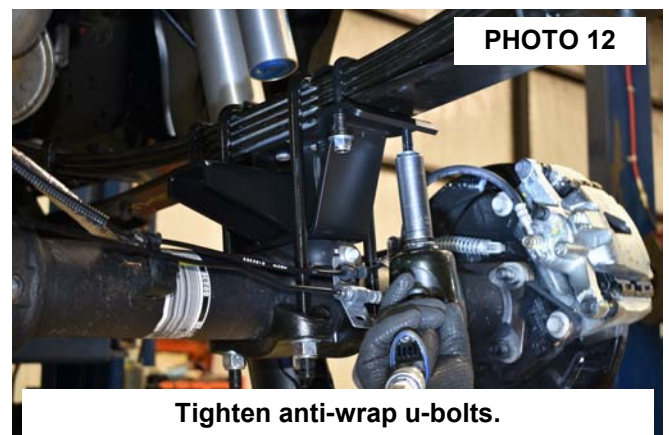
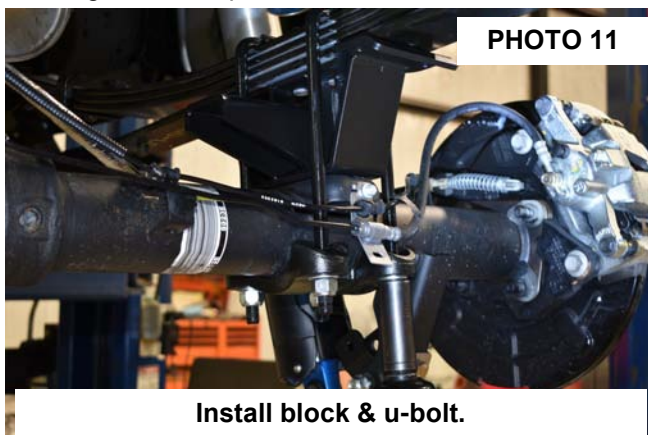



17. Install the supplied rear lower shock bracket into the factory lower shock mount using the supplied 12mm x 75mm bolt, washer, and flange lock nut (51930BAG3). Do not tighten. **See Photo 13.**
18. Install the supplied 1/2" x 1.5" bolt and square washer (51930BAG3) into the rear of the factory lower shock mount. **See Photo 14.**



19. Place the supplied 1/2" washer and nylock nut into the front of the factory lower shock mount and onto the 1/2" x 1.5" bolt (51930BAG3). **See Photo 15.**
20. Torque the 1/2" hardware using a 3/4" socket and wrench, to 90ft/lbs. **See Photo 16.**

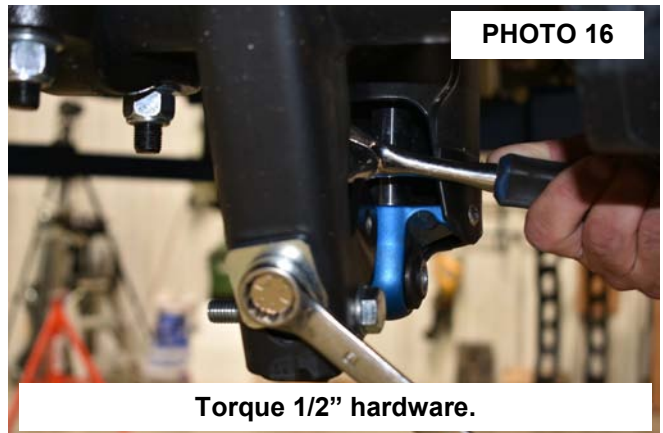
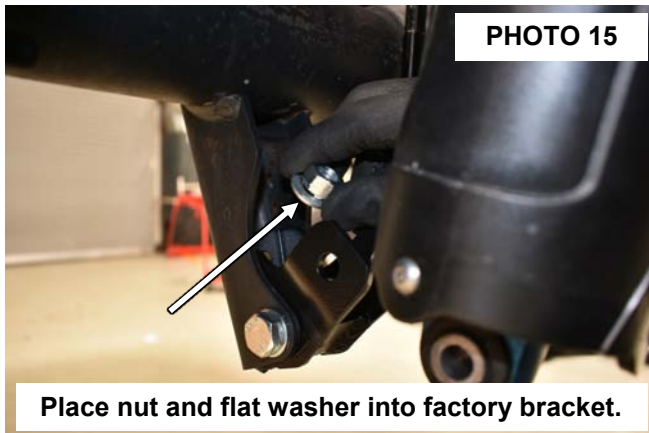

21. Install the shock into the relocation bracket using the factory hardware. Torque to factory specs using a 15mm wrench and an 18mm socket. **See Photo 17.**
22. Torque the lower shock bracket bolt to 75ft/lbs using an 18mm socket and wrench. **See Photo 18.**

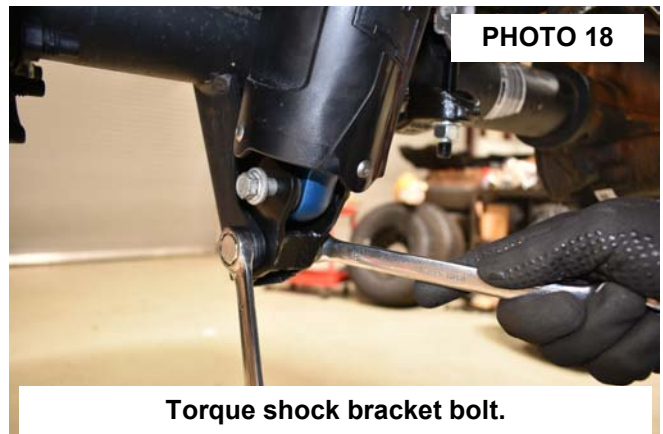
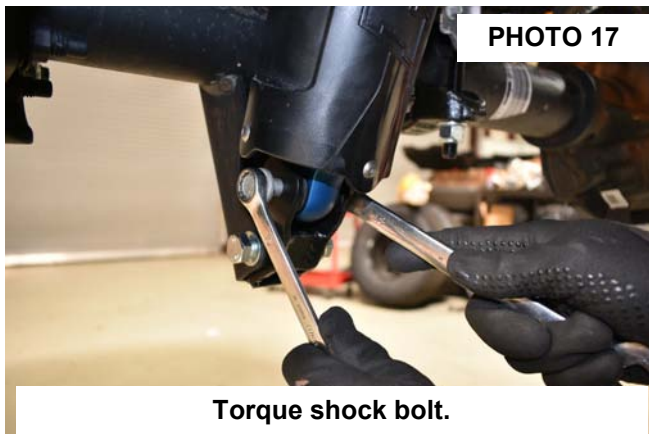

23. Install the tire and wheels.
24. Raise up the rear of the vehicle and remove the jack stands. Lower the vehicle to the ground.

## **POST INSTALLATION INSTRUCTIONS**

1. Check all fasteners for proper torque. Check to ensure there is adequate clearance between all rotating, mobile, fixed and heated members. Check steering gear for interference and proper working order. Test brake system
2. Perform steering sweep. Check to ensure brake hoses have sufficient slack and will not contact rotating, mobile, or fixed members, adjust lines/brackets to eliminate interference and maintain proper working order. Failure to perform inspections may result in component failure
3. Readjust headlights to factory settings
4. Have vehicle aligned by a certified alignment professional to factory specifications.
5. Re-torque all nuts, bolts, and especially u-bolts after the first 100 miles, again after another 100 miles and then check periodically thereafter
6. All components must be retightened after 500 miles, and every three thousand miles after installation.

### **Thank you for purchasing a Rough Country Suspension System.**

By purchasing any item sold by Rough Country, LLC, the buyer expressly warrants that he/she is in compliance with all applicable , State, and Local laws and regulations regarding the purchase, ownership, and use of the item. It shall be the buyers responsibility to comply with all Federal, State and Local laws governing the sales of any items listed, illustrated or sold. The buyer expressly agrees to indemnify and hold harmless Rough Country, LLC for all claims resulting directly or indirectly from the purchase, ownership, or use of the items.

