

ROUGH COUNTRY

SUSPENSION SYSTEMS®



1368BAG4

2014-16 2500 Dodge 5" Lift Kit

Thank you for choosing Rough Country Suspension for your Off Road needs.

Rough Country recommends a certified technician installs this system. In addition to these instructions, professional knowledge of disassemble/reassembly procedures as well as post installation checks must be known. Attempts to install this system without this knowledge and expertise may jeopardize the integrity and/or operating safety of the vehicle. Average professional install time for this kit is 4-6 hours.

Please read all the instructions before beginning the installation. Check the kit hardware against the kit contents list on the last page. Be sure you have all the needed parts and understand where they go.

⚠ WARNING

Product Use Information

As a general rule, the taller a vehicle is the easier it will roll. We strongly recommend, because of roll-over possibility, that the vehicle be equipped with a functional roll-bar and cage system. Seat belts and should harnesses should be worn at all times. Avoid situations where a side rollover may occur.

Also check the steering stabilizer. It is a good idea when adding larger than stock tires to go with a larger bore steering stabilizer or a dual unit for tires 35+and above. Inspect the stabilizer and replace as necessary.

⚠ WARNING

Braking performance and capability are decreased when significantly large/heavier tires and wheels are used. Take this into consideration while driving.

Do not add, alter, or fabricate any factory or after-market parts which increase vehicle height over the intended height of the Rough Country product purchased. Mixing component brands, lifts, and/or combining body lift with suspension lifts voids all warranties. Rough Country makes no claims regarding lifting devices and excludes any and all implied claims. We will not be responsible for any product that is altered.

⚠ NOTICE

This suspension system was developed for 37x12.50 tire on an aftermarket 17+x 9+or 20+wheels with a minimum of 5+back spacer. When larger tires are installed, speedometer recalibration is necessary. Due to ride height inconsistencies from the factory you may need to slightly trim the front plastic valance for proper tire clearance.

On vehicles equipped with a two piece driveshaft & carrier bearing as on the Mega Cab, there is the potential for take off vibration, depending on the severity this can be corrected with shimming down the carrier bearing. Carrier bearing drop kit Part # 1110 is available from Rough Country.

⚠ NOTICE

Notice to Dealer and Vehicle Owner

Any vehicle equipped with any Rough country product must have the Warning to Driver+decal installed on the sun visor or dash. The decal is to act as a constant reminder for whoever is operating the vehicle of its unique handling characteristics. **INSTALLING DEALER—It is your responsibility to install the warning decal and to forward these installation instructions to the vehicle owner for review and to be kept in the vehicle for its service life.**

Tools and Supplies Needed to Install Kit

1. Torque Wrenches	8. Pitman Arm Puller
2. ½+Drive Ratchet and Sockets	9. Hammers
3. Assorted Combination Wrenches	10. C-Clamps
4. Heavy Duty Jack Stands	11. Center Punch
5. Hydraulic Floor Jacks	12. 17/32+Drill Bit
6. Channel Locks	13. 9/16+Drill Bit
7. Anti-Seize Compound	14. 3/8+Drill Bit (at least 6+long)



Kit Contents:**Poly Bags:**

2-Front Coil Spring Spacers or Coil Springs
 1-Front Track Bar Bracket
 2-Front Sway Bar Brackets
 1-Pitman Arm (6615)
 2-Rear Coil/Air Bag Spring Spacers
 1-Rear Track Bar Bracket
 4-Shock Absorber (658737)
 1-Driver Radius Arm
 1-Passenger Radius Arm
 2-Rear Sway Bar Links
 2-Rear Bump Stop Brackets
 2-Rear Ride Height Arms (396.20)

1368Bag1:
 1-18mm Locknut
 1-18mm X 80mm Bolt
 1-18mm Washer
 1-1/2+X 1.25+Bolt
 1-1/2+x 1.5+Bolts
 2-1/2+Washers
 2-1/2+Lock Nut
 4-3/8+Lock Washers
 4-3/8+Nuts
 2-3/8+x 1.5+Bolts
 4-3/8 x 1.25+Bolts
 4-3/8+Flat Washers
 4-7/16+X 1 1/4+Bolt
 4-7/16+Lock Nut
 8-7/16+Flat Washer
 2-5/16+x 3/4+Bolt
 2-5/16+Lock Nut
 2-5/16+Flat Washer

1368Bag2:
 5-1/2+x 1.25+Bolts
 1-1/2+Locking Nut
 4-10mm x 100mm Bolts
 4-3/8+Flat Washers
 4-12mm x 65mm Bolts
 4-12mm Flange Lock Nuts
 1-9/16+x 4.0+Bolt
 1-9/16+Locking Nut
 1-9/16+Flat Washer

396.20**373.20/367.20**

FRONT SUSPENSION INSTALLATION

1. Secure and block the rear tires of the vehicle on a level concrete or asphalt surface
2. Raise the front of the vehicle and support the frame with jack stands. Remove the front wheels and tires and set aside. Position a hydraulic jack under the front axle and raise the jack until the front suspension begins to compress
3. On both sides of the vehicle, scribe alignment marks on the adjustment cam and axle bracket at the lower axle bolt of the radius arm for later reference.
4. Unbolt the brake line brackets from the inside of the frame using a 13mm wrench to ensure brake line free play during the suspension system installation. **See Photo 1.** Retain stock hardware for later use.
5. Unplug the electrical connector for the four wheel drive engagement. **See Photo 2.**

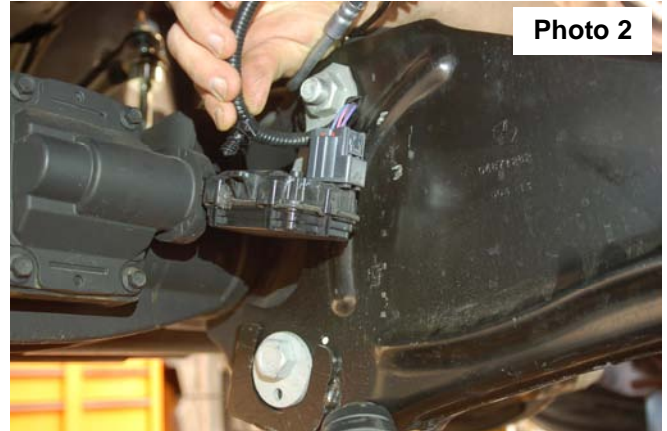

6. Remove the sway bar links by unbolting the lower sway bar nut as shown in **Photo 3** using a 10mm socket and a 21mm wrench.
7. Remove the track bar from its upper mounting point on the frame using a 1 1/16+ wrench and rest it on the axle. It may be helpful to loosen the lower track bar bolt on the axle. Retain hardware for reuse.
8. Remove the cotter pin, and castle nut from the drag link where it connects to the pitman arm. A pitman arm tool may be needed to separate the drag link from the pitman arm. Remove the stock nut, and lock washer from the sector shaft on the steering box. Save hardware for later installation. Using a pitman arm puller carefully remove the stock pitman arm.
9. Remove the front shocks with a 18mm wrench for the upper stud and a 21mm socket for the lower bolt. **See Photo 4.** Retain lower shock mount factory hardware.

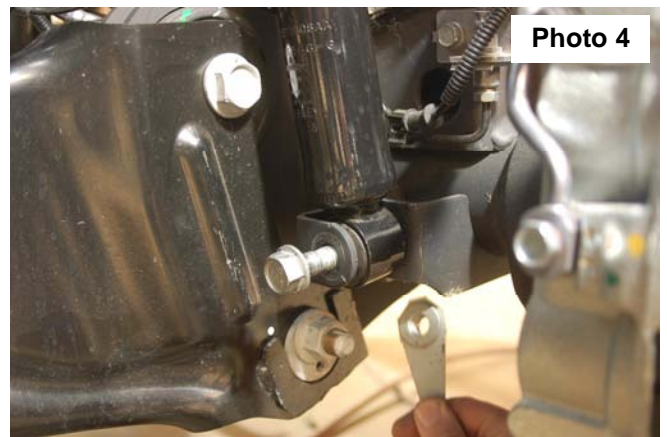
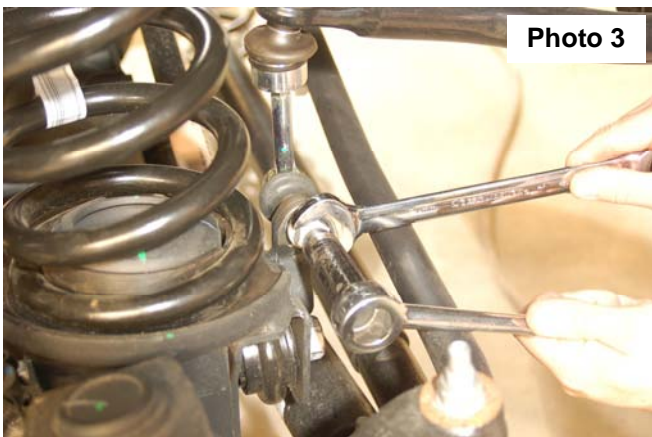

10. Lower the axle and remove the coil springs. Note there is a rubber push pin made on to the factory coil isolator to align the coil spring. Push on the top the pin to release the isolator from the frame coil pocket.
11. Using a 24mm socket and wrench remove the two bolt holding the driver radius arm to the axle. Retain factory hardware.
12. Next remove the radius arm bushing bolt with a 27mm socket and wrench. Retain factory hardware.

13. Install the supplied driver side radius arm with factory hardware. **See Photo 5.** Note the offset side of the radius arm goes to the outside of the truck. Do not tighten the radius arm bushing bolt until the truck is setting on the ground.
14. Repeat steps 11-13 on the passenger side.
15. **Coil spring kits, use template (last page) to rotate spring isolator, skip to step 19.** Insert the coil spacer retainer in the coil pocket from the bottom side. Make sure the nut is facing down. **See Photo 6** Using the 3/8+x 1.5 bolt and washer, bolt the coil spacer into the coil pocket. Align the rear hole up with the existing alignment hole in the tower before tightening the center bolt

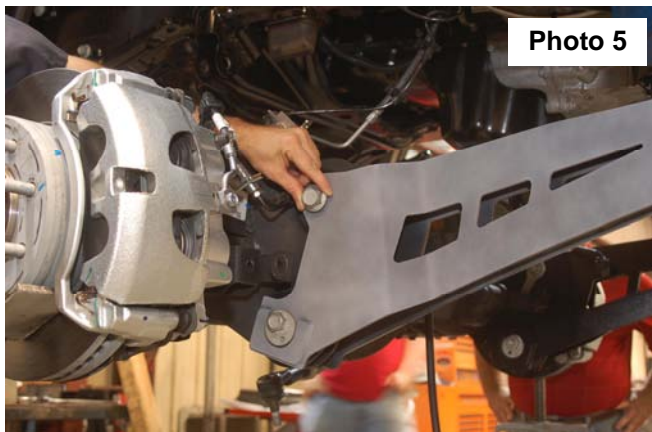

Photo 5



Photo 6

16. Use the supplied 3/8-x 1.25+bolt, washer, and nut to bolt the spacer to the existing hole. **See Photo 7.**
17. The front hole will have to be drilled with a 3/8+long drill bit. **See Photo 8.** Then use the supplied 3/8-x 1.25+bolts, washers, and nuts to tighten. If you do not have a long enough drill you can mark the hole remove the spacer and then drill the hole.



Photo 7

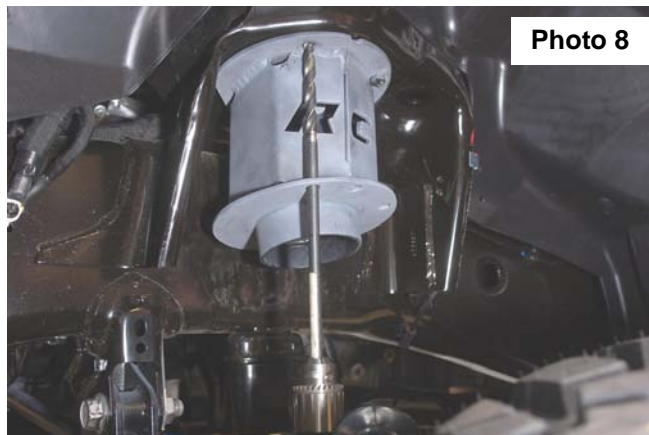

Photo 8

18. Place the coil spring isolator on the bottom of the coil spring spacer and align the push pin in the rear hole directly below the factory hole in the coil pocket. **See Photo 9.** Next install the factory coil springs.
19. Install the new front shocks using the supplied bushings for the top mount and using factory hardware for the lower mount. Tighten the upper mount with a 18mm wrench and the lower mount with a 21mm socket.
20. Remove the factory bump stop and replace it with the new supplied longer bump stop. **See Photo 10.**



Photo 9



Photo 10

21. Install the new pitman arm into the stock location on the sector shaft, using stock hardware and torque to 185 ft. lbs.
22. Remove the pitman arm ball joint from the steering link. The flat will need to be cut off so you can rotate the ball joint for the new pitman arm. **See Photo 11.** Install the steering link ball joint onto the pitman arm using stock hardware.
23. Install the new supplied track bar bracket with the factory bolt. Hand tighten. Swing the bracket up to the cross member and mark the hole location for the support bolt, then remove the bracket. Drill the marked hole with a 17/32 drill bit. ***Note*** be careful not to drill into the oil pan. Place a block of wood or steel plate between oil pan and cross member. Install the track bar bracket and tighten factory bolt with a 1 1/16+socket and tighten the 1/2+x 1.25+bolt with a 19mm socket and wrench. **See Photo 12.** The bolt should be installed from the bottom.



Photo 11



Photo 12

24. The track rod will be installed into the new mount after the vehicle is on the ground.
25. Remove the sway bar hardware using a 18mm wrench as shown in **Photo 13** and allow the sway bar to separate from the frame.
26. Install the sway bar drop bracket and secure to the frame using the factory hardware. Tighten with a 18mm wrench.
27. Install the sway bar to the new bracket with the supplied 7/16+x 1 1/4+bolts, flat washers and nuts. **See Photo 14.** Tighten using a 9/16+socket and wrench.



Photo 13



Photo 14

28. Install the front **Driver Side (2 Bends)** brake line bracket to the frame using factory hardware. **See Photo 15.** Attach the brake line mount to the new bracket with the supplied 5/16+x 3/4+bolts, washer, and nuts. Tighten with a 13mm socket and wrench.
29. Attach the brake line mount to the new bracket with the supplied 5/16+x 3/4+bolts, washer, and nuts. Tighten with a 13mm socket and wrench. Install the front **Passenger Side (1 Bend)** brake line bracket with bend at bottom away from frame, use factory hardware. **See Photo 16.**



Photo 15



Photo 16

30. Install the tires / wheels and then lower the truck to the ground.
31. Install the track rod in the new bracket using the supplied 18mm x 80mm bolt, washers, and lock nut. Tighten using a 1 1/16+socket and wrench.
32. Tighten the radius arm bolt with a 1 1/16+socket.

REAR INSTALLATION

If your truck is equipped with rear air suspension, skip to page 9 for rear installation instructions.

1. Secure and block the front tires of the vehicle on a level concrete or asphalt surface.
2. Using a 21mm wrench remove the track bar bolt on the frame. Raise the rear of the vehicle and support the frame with jack stands. Remove the rear wheels and tires and set aside.
3. Un-couple the e-brake cable on the drivers side of the vehicle. **See Photo 1.**
4. Remove the cable from the body mount using pliers to release the cable clips as shown in **Photo 2**



Photo 1



Photo 2

5. Remove the cable and place the supplied drilling template in place, making sure the template has the new hole placed directly below factory hole. The template may be tapped in place.
6. Drill the new hole as shown using a 9/16+drill bit. **See Photo 4.**



Photo 3

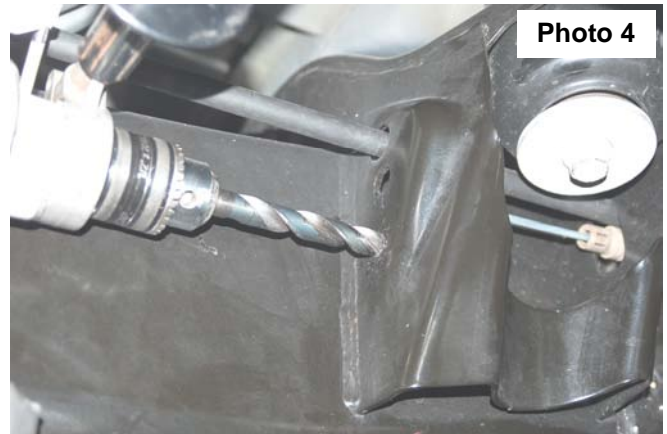

Photo 4

7. Install the e-brake line bracket on the e-brake line as shown in **Photo 5**, making sure the bracket snaps into place.
8. Install the supplied brake line bracket as shown in **Photo 6** with the supplied 1/2-x 1 1/2qbolts, flat washers and lock nut. Tighten using a 19mm wrench / socket.

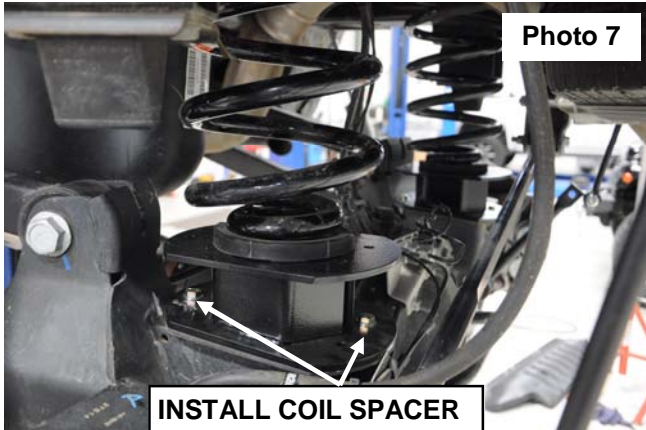

Photo 5



Photo 6

9. Remove the inner fender well using a 8mm socket. 11 bolts to remove. One of the bolts is hidden behind the fender flare on the front side.
10. Remove the rear shock with a 21mm wrench for the lower and a 18mm wrench for the upper mount.
11. Using a 18mm wrench and socket remove the sway bar link.
12. Lower the axle and remove the coil spring and spring isolator.
13. Install new spacer on axle with the shorter side to the front of the truck, secure spacer to axle using supplied 3/8+ bolts, nuts, and washers. Tighten using 9/16+ wrenches. **See Photo 7** Install coil spring and spring isolator onto lower coil spacer, raise axle making sure spring is seated properly on top and bottom.
14. Measure 3/4+ from the bottom of the bracket and mark a line. Using a saw cut the end of the track bar bracket off as shown in **Photo 8**. Note you will only cut the one tab.



15. Install the new supplied track bar bracket with the crush sleeve using the supplied 9/16+x 4.0+ bolt, washer, and nut. Hand tighten. Use the bracket has a template and drill the hole using a 17/32+ drill bit. Next install the 1/2+x 1.25+ bolt and nut in the dilled hole. Tighten the 9/16+ bolt with a 21mm and 22mm wrench and tighten the 1/2+ bolt with a 19mm socket and wrench. **See Photo 9.**
16. Install the new rear shock absorbers part # 658737 with the supplied stem bushings. Tighten with a 19mm for the top and a 21mm for the lower bolt. **See Photo 10.**



17. Next install the rear sway bar links using the supplied 12mm x 65mm bolts and flange nuts. Tighten with a 18mm and 19mm wrench.
18. Using a 15mm socket remove the rear bump stop from the frame. Place the bump stop extensions between the bump stop and the frame and secure with the supplied 10mm x 100mm bolts and washers. **See Photo 11.** Tighten with a 17mm socket.
19. Reinstall the inner fender wells using the factory hardware and a 8mm socket.
20. Install the wheels / tires. Jack up the vehicle and remove the jack stands.
21. Lower the vehicle to the floor.
22. Install the factory track bar to the new bracket with factory hardware. Use a 21mm socket to tighten.
23. Install the supplied e-brake extension bracket as shown in **Photo 12.**



POST INSTALLATION INSTRUCTIONS

Check all fasteners for proper torque. Check to ensure there is adequate clearance between all rotating, mobile, fixed and heated members. Check steering gear for interference and proper working order. Test brake system. Perform steering sweep. Check to ensure brake hoses have sufficient slack and will not contact rotating, mobile, or fixed members, adjust lines/brackets to eliminate interference and maintain proper working order. Failure to perform inspections may result in component failure. Re-torque all fasteners after 500 miles. Visually inspect components and re-torque fasteners during routine vehicle service. Readjust headlights to proper settings. It is the buyer's responsibility to have all bolts/nuts checked for tightness after the first 100 miles and then every 1000 miles. Suspension components every 3000 miles.

Thank you for choosing Rough Country Suspension for your Off Road needs.

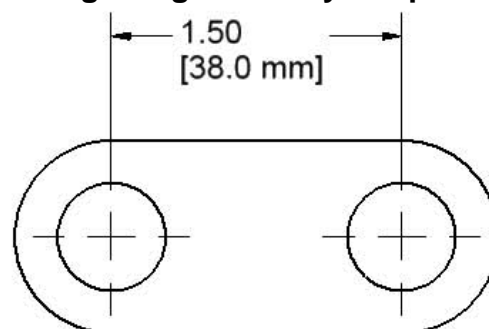

DRILLING TEMPLATE



By purchasing any item sold by Rough Country, LLC, the buyer expressly warrants that he/she is in compliance with all applicable, State, and Local laws and regulations regarding the purchase, ownership, and use of the item. It shall be the buyer's responsibility to comply with all Federal, State and Local laws governing the sales of any items listed, illustrated or sold. The buyer expressly agrees to indemnify and hold harmless Rough Country, LLC for all claims resulting directly or indirectly from the purchase, ownership, or use of the items.

REAR INSTALLATION (AIR SUSPENSION MODELS)

1. Secure and block the front tires of the vehicle on a level concrete or asphalt surface.
2. Using a 21mm wrench remove the track bar bolt on the frame. Raise the rear of the vehicle and support the frame with jack stands. Remove the rear wheels and tires and set aside.
3. Un-couple the e-brake cable on the drivers side of the vehicle. **See Photo 1.**
4. Remove the cable from the body mount using pliers to release the cable clips as shown in **Photo 2**



5. Remove the cable and place the supplied drilling template in place, making sure the template has the new hole placed directly below factory hole. The template may be tapped in place.
6. Drill the new hole as shown using a 9/16+drill bit. **See Photo 4.**



7. Install the e-brake line bracket on the e-brake line as shown in **Photo 5**, making sure the bracket snaps into place.
8. Install the supplied brake line bracket as shown in **Photo 6** with the supplied 1/2-x 1 1/2 inch bolts, flat washers and lock nut. Tighten using a 19mm wrench / socket.



9. Remove the inner fender well using a 8mm socket. 11 bolts to remove. One of the bolts is hidden behind the fender flare on the front side.
10. Using pliers, remove the sensor arm from the axle .
11. Remove the rear shock with a 21mm wrench for the lower and a 18mm wrench for the upper mount.
12. Look under the passenger side rear door for the air compressor. Using a 12mm wrench loosen both the green and white lines slowly to release air pressure from the air bags. **See Photo 7.**
13. Using a 13mm wrench, remove the lower airbag mounting nuts. **See Photo 8.**

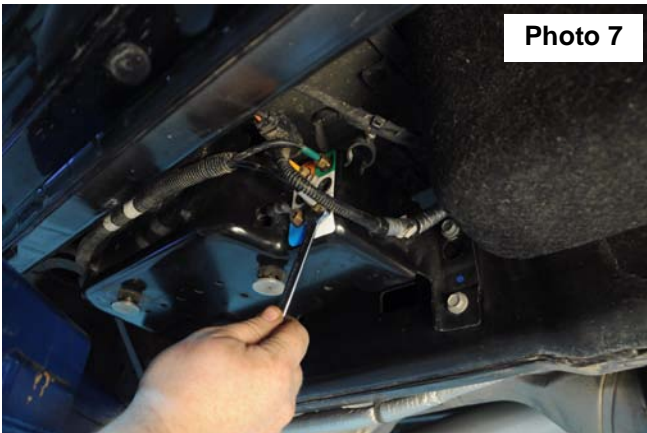

Photo 7

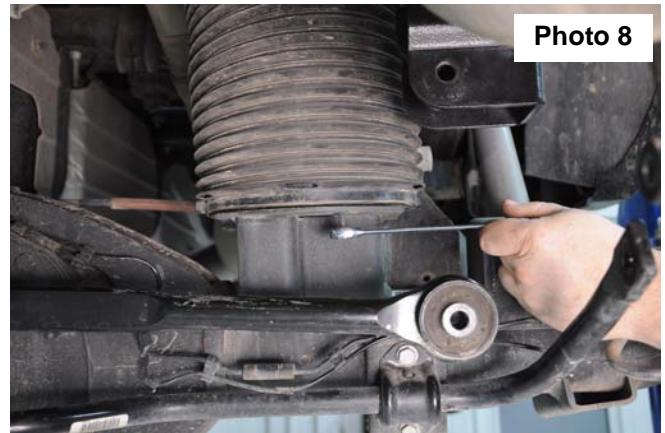

Photo 8

14. Install new spacer on axle with the shorter side to the front of the truck, secure spacer to axle using supplied 3/8+ bolts, nuts, and washers. Tighten using 9/16+ wrenches. **See Photo 9.**
15. Using stock hardware, secure the airbag to the spacer and tighten using a 13mm wrench. **See Photo 10.**



Photo 9



Photo 10

17. Using a 15mm socket remove the rear bump stop from the frame. Place the bump stop extensions between the bump stop and the factory spacer and secure with the supplied 10mm x 140mm bolts and washers. **See Photo 11.** Tighten with a 17mm socket.
18. Remove the ball stud from the lower axle using a 10mm wrench. **See Photo 12.**

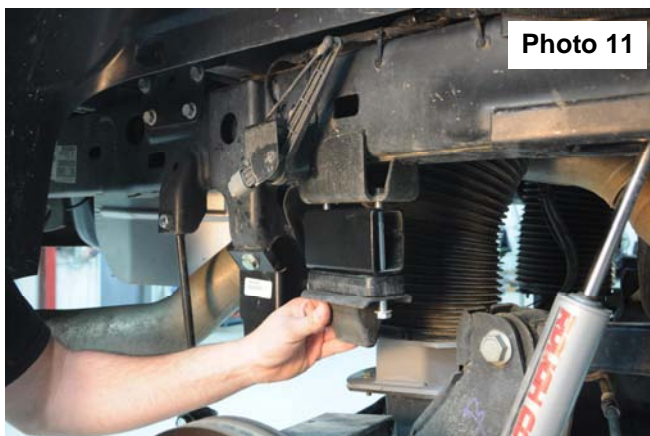

Photo 11

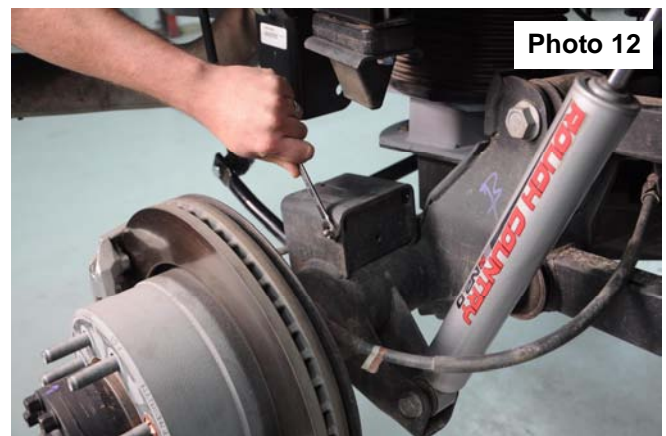
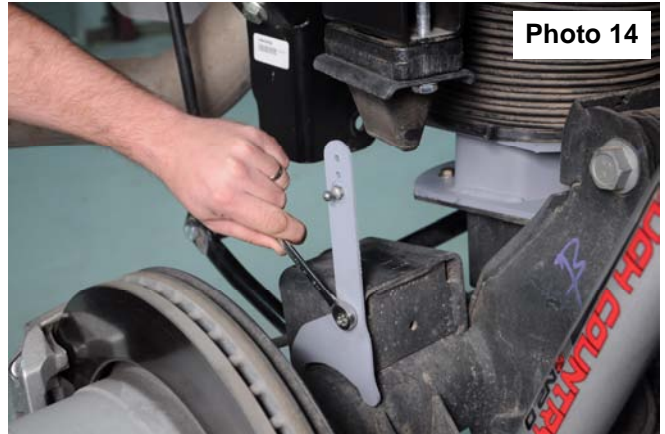
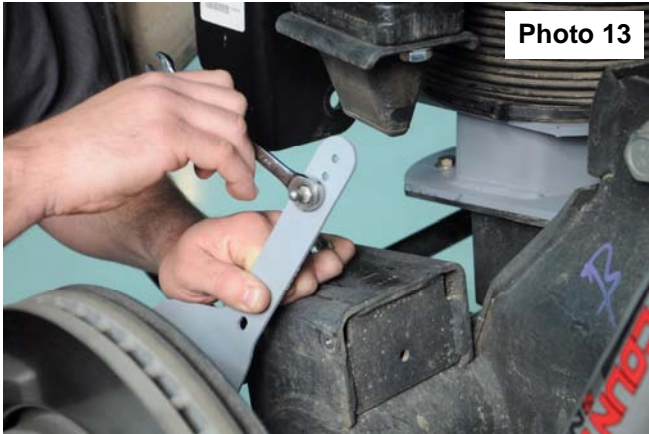
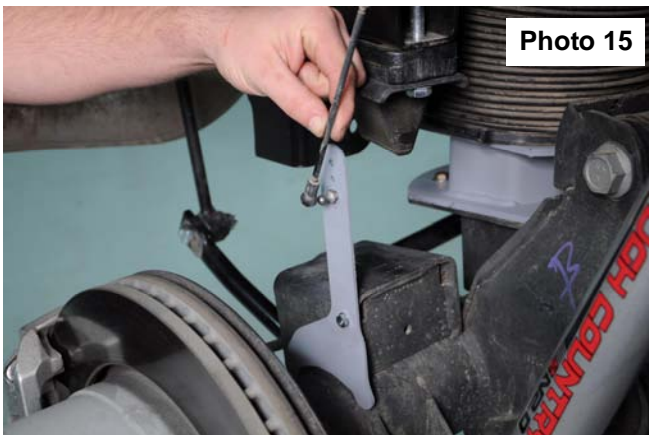

Photo 12

19. Install the ball stud into the bottom hole on the new leveling arm. **See Photo 13.**
20. Using the supplied 6mm bolt and washer, install the leveling arm on the axle. Tighten using a 10mm wrench. **See Photo 14.**



21. Install sensor arm onto ball stud. **See Photo 15.** Ball stud can be moved to change ride height.
22. Measure 3/4" from the bottom of the track bar bracket and mark a line. Using a saw, cut the end of the track bar bracket off as shown in **Photo 16.** Note you will only cut the one tab.



23. Install the new supplied track bar bracket with the crush sleeve using the supplied 9/16"x 4.0" bolt, washer, and nut. Hand tighten. Use the bracket has a template and drill the hole using a 17/32" drill bit. Next install the 1/2"x 1.25" bolt and nut in the drilled hole. Tighten the 9/16" bolt with a 21mm and 22mm wrench and tighten the 1/2" bolt with a 19mm socket and wrench. **See Photo 17.**
24. Install the new rear shock absorbers part # 658737 with the supplied stem bushings. Tighten with a 19mm for the top and a 21mm for the lower bolt. **See Photo 18.**



25. Next install the rear sway bar links using the supplied 12mm x 65mm bolts and flange nuts. Tighten with a 18mm and 19mm wrench.
26. Using a 15mm socket remove the rear bump stop from the frame. Place the bump stop extensions between the bump stop and the frame and secure with the supplied 10mm x 140mm bolts and washers. **See Photo 19.** Tighten with a 17mm socket.
27. Using a 12mm wrench tighten the green and white air lines.
28. Reinstall the inner fender wells using the factory hardware and a 8mm socket.
29. Install the wheels / tires. Jack up the vehicle and remove the jack stands.
30. Lower the vehicle to the floor.
31. Install the factory track bar to the new bracket with factory hardware. Use a 21mm socket to tighten.
32. Install the supplied e-brake extension bracket as shown in **Photo 20.**



POST INSTALLATION INSTRUCTIONS

Check all fasteners for proper torque. Check to ensure there is adequate clearance between all rotating, mobile, fixed and heated members. Check steering gear for interference and proper working order. Test brake system. Perform steering sweep. Check to ensure brake hoses have sufficient slack and will not contact rotating, mobile, or fixed members, adjust lines/brackets to eliminate interference and maintain proper working order. Failure to perform inspections may result in component failure. Re-torque all fasteners after 500 miles. Visually inspect components and re-torque fasteners during routine vehicle service. Readjust headlights to proper settings. It is the buyer's responsibility to have all bolts/nuts checked for tightness after the first 100 miles and then every 1000 miles. Suspension components every 3000 miles.

Thank you for choosing Rough Country Suspension for your Off Road needs.

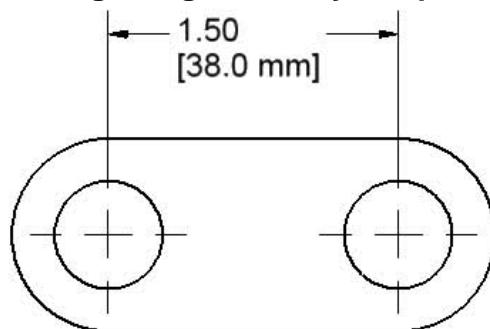

DRILLING TEMPLATE



By purchasing any item sold by Rough Country, LLC, the buyer expressly warrants that he/she is in compliance with all applicable, State, and Local laws and regulations regarding the purchase, ownership, and use of the item. It shall be the buyer's responsibility to comply with all Federal, State and Local laws governing the sales of any items listed, illustrated or sold. The buyer expressly agrees to indemnify and hold harmless Rough Country, LLC for all claims resulting directly or indirectly from the purchase, ownership, or use of the items.

Ø6.29
[159.9 mm]

