



OPEN FENDER MANUAL

2018

INSTALLATION INSTRUCTIONS

OPEN FENDER SYSTEM

PRODUCT NUMBER: TF2900

APPLICATION: 2016+ DODGE RAM 2500/3500



IMPORTANT SAFETY GUIDE

Your safety and the safety of others is very important.

In order to help you make informed decisions about safety, we have provided the following warnings, safety precautions, installation instructions, and other important information to alert you to potential hazards that could hurt you or others.

Please do a job safety analysis before each task to identify potential hazards for your situation and remove/protect against them. Use own good judgment and take your time. Check packaged materials immediately upon arrival to ensure that all listed parts are included and undamaged.

Read and understand all warnings, safety precautions, and instructions *before* installing this product.

WARNINGS

FAILURE TO OBSERVE THE FOLLOWING WARNINGS AND INSTRUCTIONS PROVIDED IN THIS MANUAL COULD LEAD TO SEVERE INJURY AND/OR DEATH.

FOR PROFESSIONAL INSTALLATION ONLY. CARELESS INSTALLATION AND/OR OPERATION CAN RESULT IN SERIOUS INJURY, DEATH, AND/OR EQUIPMENT DAMAGE. ALL LIABILITY FOR INSTALLATION AND USE RESTS WITH THE USER OR CONSUMER.

FAB FOURS, INC. ONLY APPROVES INSTALLING THIS PRODUCT ACCORDING TO THESE WRITTEN INSTRUCTIONS WITH THE HARDWARE PROVIDED. FAILURE TO INSTALL ACCORDING TO THESE INSTRUCTIONS WILL INVALIDATE THE WARRANTY. THIS INCLUDES, BUT IS NOT LIMITED TO, USING ALTERNATIVE INSTALLATION METHODS, HARDWARE, OR MATERIALS.

THIS PRODUCT IS FOR OFF ROAD USE ONLY.

SAFETY PRECAUTIONS

- Always remove jewelry and wear eye protection.
- Always use extreme caution when jacking up a vehicle for work. Set emergency brake and use tire blocks. Locate and use the vehicle manufacturers designated lifting points. Use jack stands.
- Always use appropriate and adequate care in lifting components into place.
- Always ensure components will remain secure during installation and operation.
- Always wear safety glasses when installing this kit. A drilling operation will cause flying metal chips.
- Flying chips can cause serious eye injury.
- Always use extreme caution when drilling a vehicle. Always disconnect power before welding.
- Thoroughly inspect the area to be drilled (on both sides of material when possible) prior to drilling, and relocate any objects that may be damaged.
- Always use extreme caution when welding a vehicle. Thoroughly inspect the area to be welded (on both sides of material when possible) prior to welding, and relocate any objects that may be a fire hazard. When welding in a cab, make sure the interior surfaces are covered (e.g., welding blanket) and a fire extinguisher is at hand.
- Always use extreme caution when cutting and trimming during fitting.
- Always tighten all nuts and bolts securely per installation instructions.
- Always route electrical cables carefully. Avoid moving parts, components that become hot, and rough or sharp edges.
- Always insulate and protect all exposed wiring and electrical terminals.
- Perform regular inspections and maintenance on mounts and hardware.
- Tire may rub at max turn or articulation.

TABLE OF CONTENTS

SAFETY	2
DISCLAIMER	2
TABLE OF CONTENTS	3
A WORD FROM THE OWNER.....	4
HOW TO USE THIS MANUAL	5
CHAPTER 1: BEFORE WE START	14
CHAPTER 2: DISASSEMBLY & PREPARATION	14
GRILLE REMOVAL	14
BUMPER REMOVAL	12
FRONT FENDER TRIM REMOVAL	15
HEADLIGHT REMOVAL	19
FRONT FENDER REMOVAL	22
CHAPTER 3: TEMPLATE MOUNTING	24
CHAPTER 4: CUTTING	32
CHAPTER 5: INSTALLATION - ROCKER CHANNEL PLATES....	40
CHAPTER 6: INSTALLATION - FENDER BASES.....	46
CHAPTER 7: INSTALLATION - INNER FENDER.....	52
CHAPTER 8: INSTALLATION - FENDER FLARES	54
APPENDIX 1: APPLYING SEAL.....	58
CONTACT INFORMATION	59



INTRO

OWNER'S MESSAGE



Thank you for purchasing our Fab Fours “Open Fender Kit”... You are not just modifying your vehicle, but participating in evolving the future of all truck and Jeep customization with us! You chose this method of tire fitment for the same reason that I invested so much to create it - we both believe that the ultimate lift truck should have no lift at all! Low slung, wide stance, optimal CG, all come together to make the baddest looking, best riding, biggest tire fitting trucks on the planet! We have gone to great lengths to perfect this system, knowing the risks in cutting a brand new vehicle - please follow the instructions and videos carefully to ensure proper execution and you will be on your way soon with a #40sNolift truck!

Welcome to the family!

Ereg Higgs

FOUNDER, FAB FOURS

HOW TO USE THIS MANUAL

This technical manual is meant to be a comprehensive companion to online video resources. Few manuals offer a similar combination of hands-on information, color images, and video instruction. Our goal is to provide this comprehensive instruction in bite-sized and manageable chunks that an individual will feel comfortable using.

THIS IS NOT A REPLACEMENT FOR THE PROFESSIONAL SKILLS AND EXPERIENCE REQUIRED, BUT A SUPPLEMENTAL REFERENCE.



VIDEO GUIDED

Where ever this icon is located there are supplementary videos. These video will be given at the head of every section by an accompanying path name for locating them on the web site.

UNIQUE TOOLS & HARDWARE

Where ever this icon is located there are special tools required for installation.

MEASUREMENT

Where ever this icon is located it indicates a measurement or adjustment that is required at this stage in installation.

EXTRA CARE REQUIRED

Take care when executing the steps. Damage to part or vehicle could make installation more difficult and time consuming.

CHAPTER 1

BEFORE YOU START

TF2900 OPEN FENDER BASE

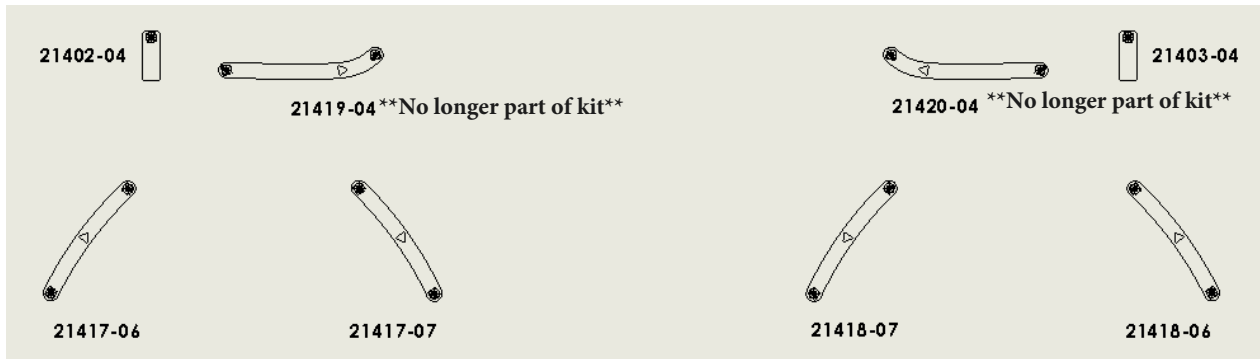

****21419-04
21420-04
are no longer included in the kit and not necessary****

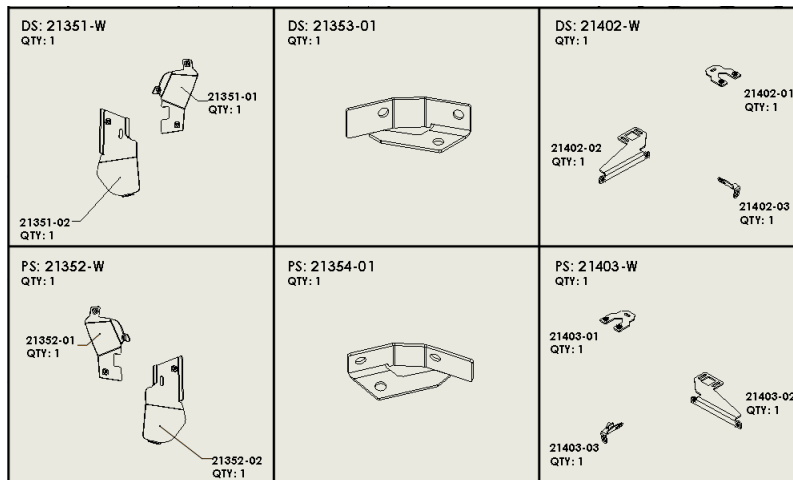
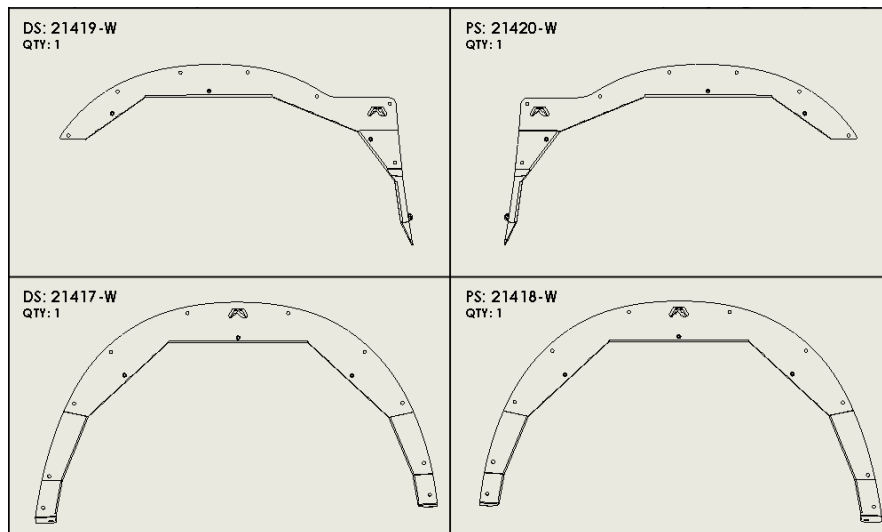

INSTALLATION INSTRUCTIONS

OPEN FENDER SYSTEM

Product Number: TF2900

Application: 2016 DODGE RAM 2500

TF2900 HW-KIT

Fully layout and account for all hardware and accessories.

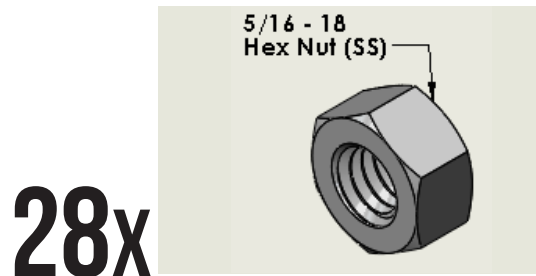
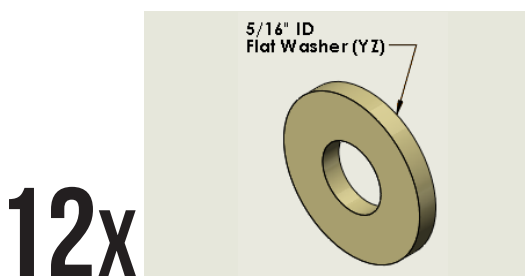
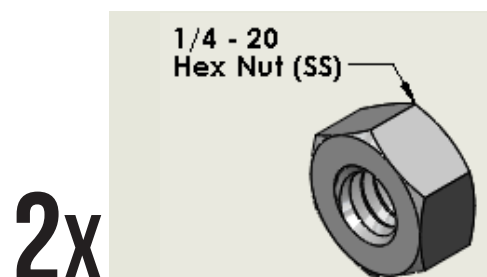
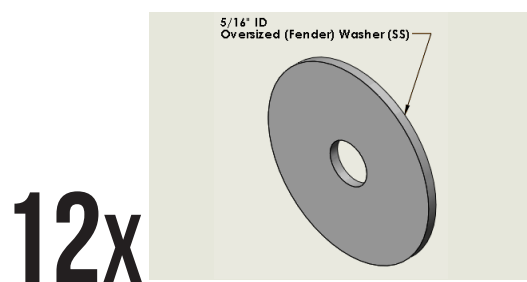
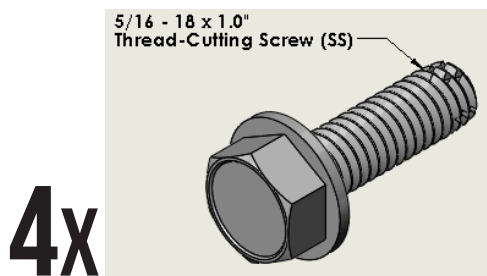
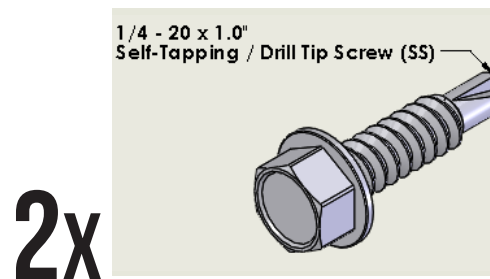
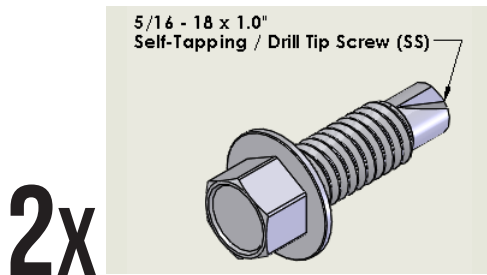

TF2900 HW-KIT

Fully layout and account for all hardware and accessories.

4x

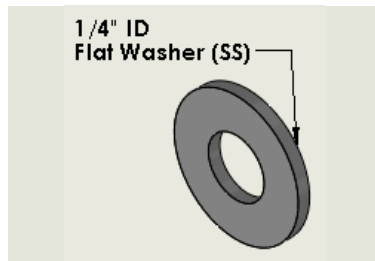

2x

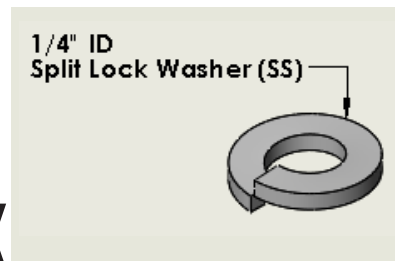

28x

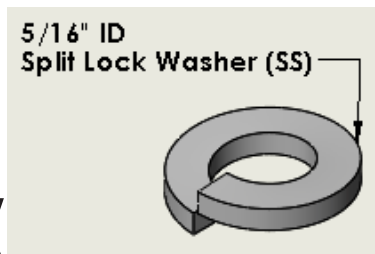

2x

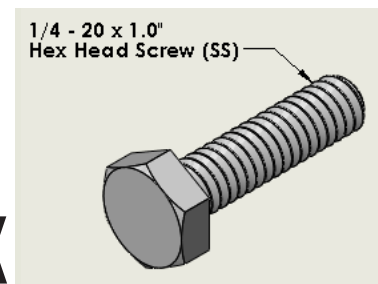

10x

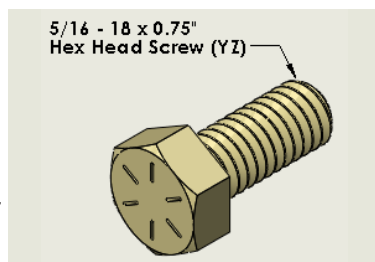

60x

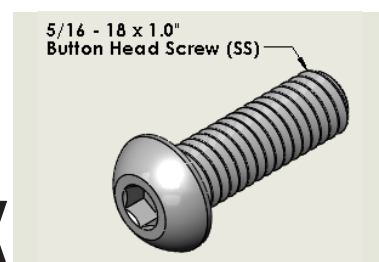

16x

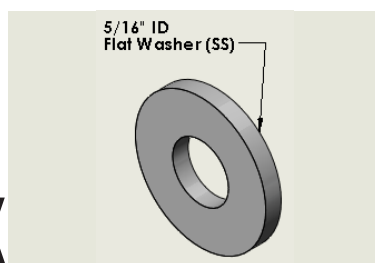

60x

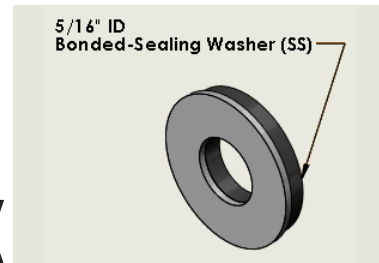

INSTALLATION INSTRUCTIONS OPEN FENDER SYSTEM

Product Number: TF2900

Application: 2016 DODGE RAM 2500

2x

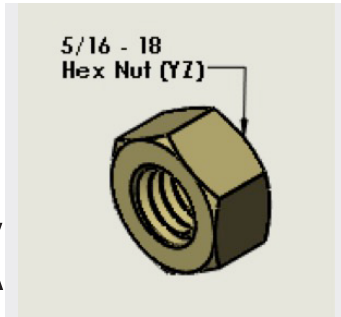

****PART #61729- LEVELING KIT NO LONGER INCLUDED****

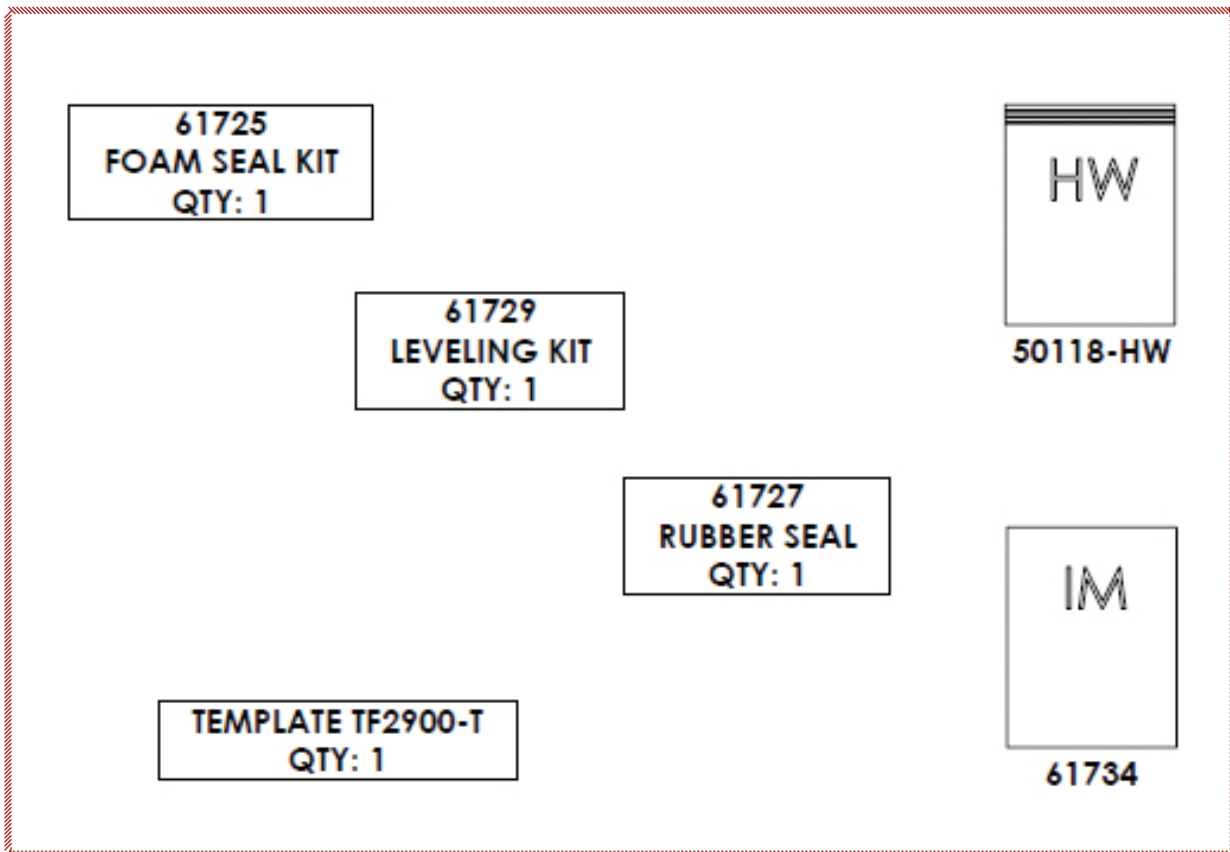

TF2910 OPEN FENDER FLARE

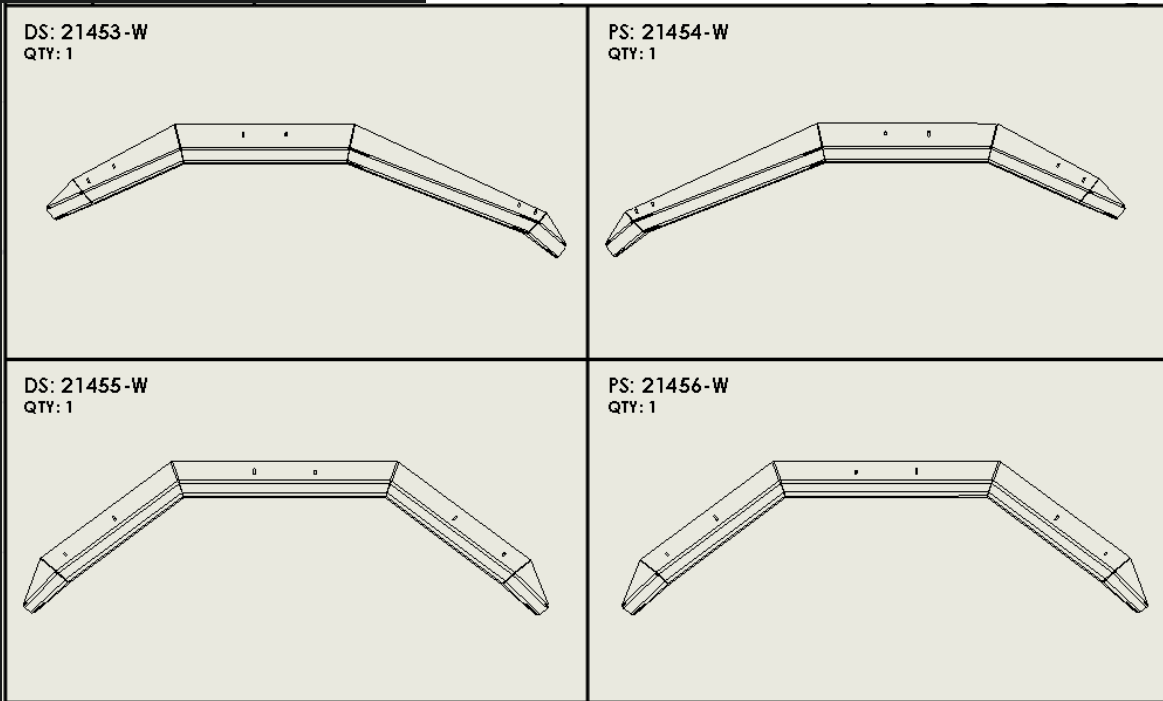

TF2910 HW-KIT

Fully lay out and account for all hardware and accessories.

12x

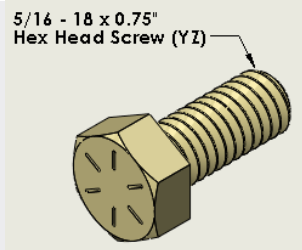

12x

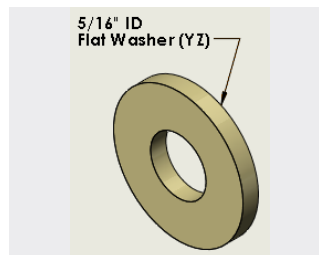

12x

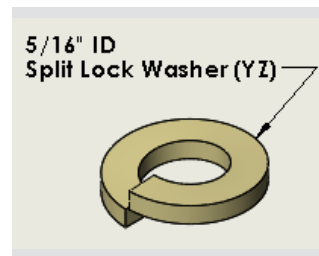

INSTALLATION INSTRUCTIONS OPEN FENDER SYSTEM

Product Number: TF2900
Application: 2016 DODGE RAM 2500

TF2900 OPEN FENDER INNER

DS: 21449-W
QTY: 1

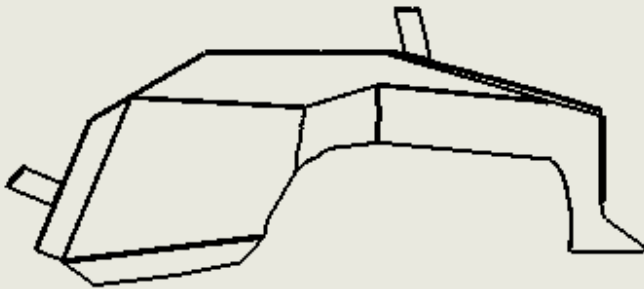

PS: 21450-W
QTY: 1

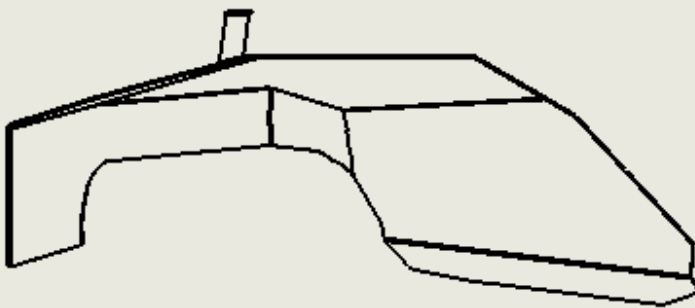

INSTALLATION INSTRUCTIONS OPEN FENDER SYSTEM

Product Number: TF2900

Application: 2016 DODGE RAM 2500

[TF2900 OPEN FENDER TEMPLATES]

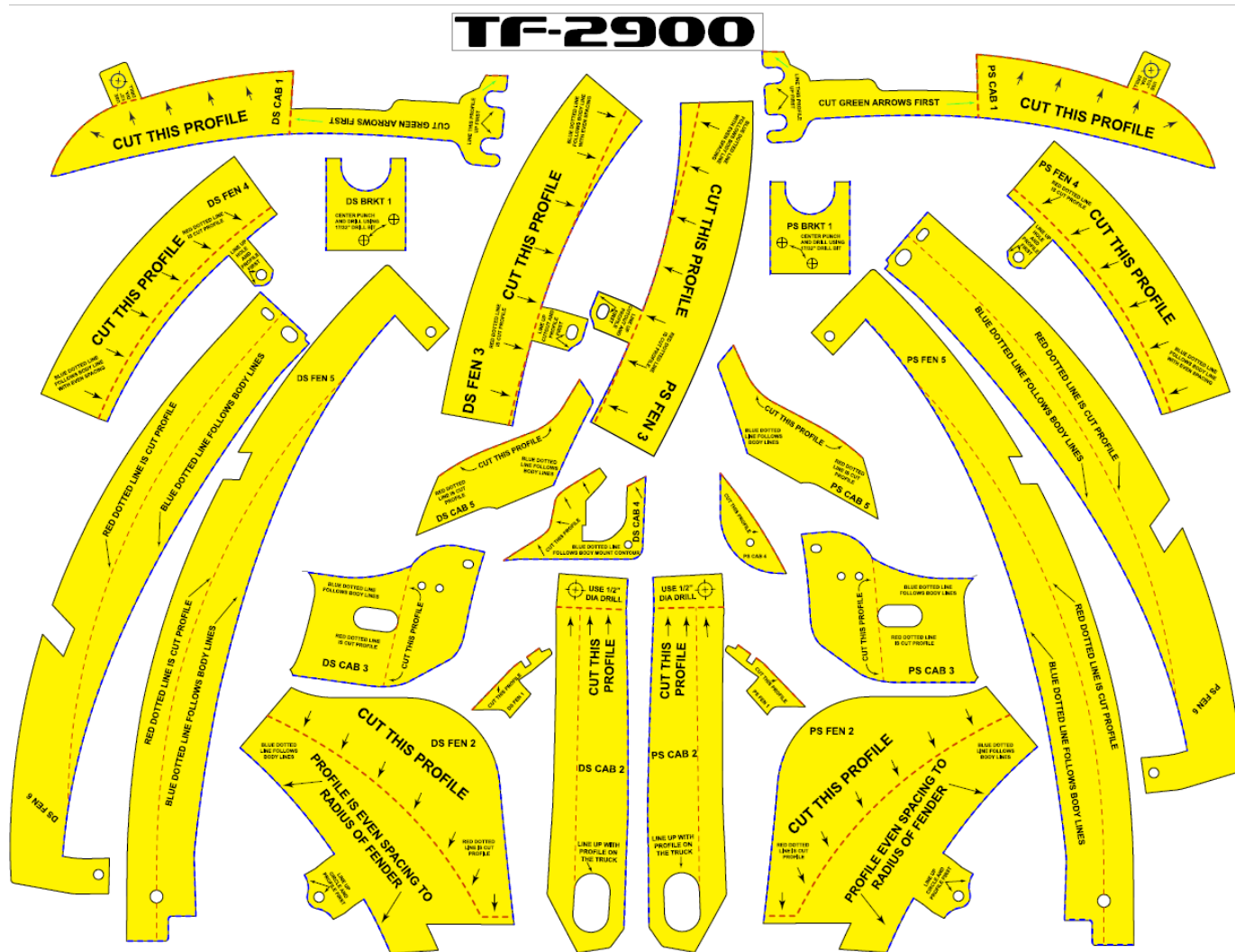

INSTALLATION INSTRUCTIONS

OPEN FENDER SYSTEM

Product Number: TF2900

Application: 2016 DODGE RAM 2500

Using pads or other protective surface, lay out all the parts provided by Fab Fours. Failure to fully account for all components before beginning installation may leave vehicle immobile until part is acquired. Refer to following list.

TOOLS REQUIRED:

- Socket wrench with extension (ratcheting wrenches may also be convenient)
- Full set of sockets metric and standard
- Full set of wrenches and ratchet wrenches
- Flat and Phillips head screw drivers
- Electric Drill with drill bit set up to ½"
- Plastic Fastener Remover
- Reciprocating saw
- Cutting wheel
- Grinding wheel
- Tin snips
- T15 torx
- Hex key sets
- Step bit

ORGANIZATION:

Keeping your surroundings both clean and organized is paramount. Disassemble the vehicle where you can catalog and store everything. One good example is labeling and bagging all the OEM bolts when removing the front clip of the vehicle. Failure to keep track of parts could lead to an inability to properly reinstall components.

TEMPLATES:

Blue dotted lines follow body lines of truck. Red dotted lines indicate cut lines. Drawn holes with center mark indicate drill locations. Holes and slots cut in template indicate locating features that must be matched.

EASE OF ACCESS:

Removing the tires and raising the vehicle is recommended at this time. We recommend the use of an appropriately rated lift when installing.

CHAPTER 2

DISASSEMBLY & PREPARATION

1

Grille Removal: Removing radiator seal

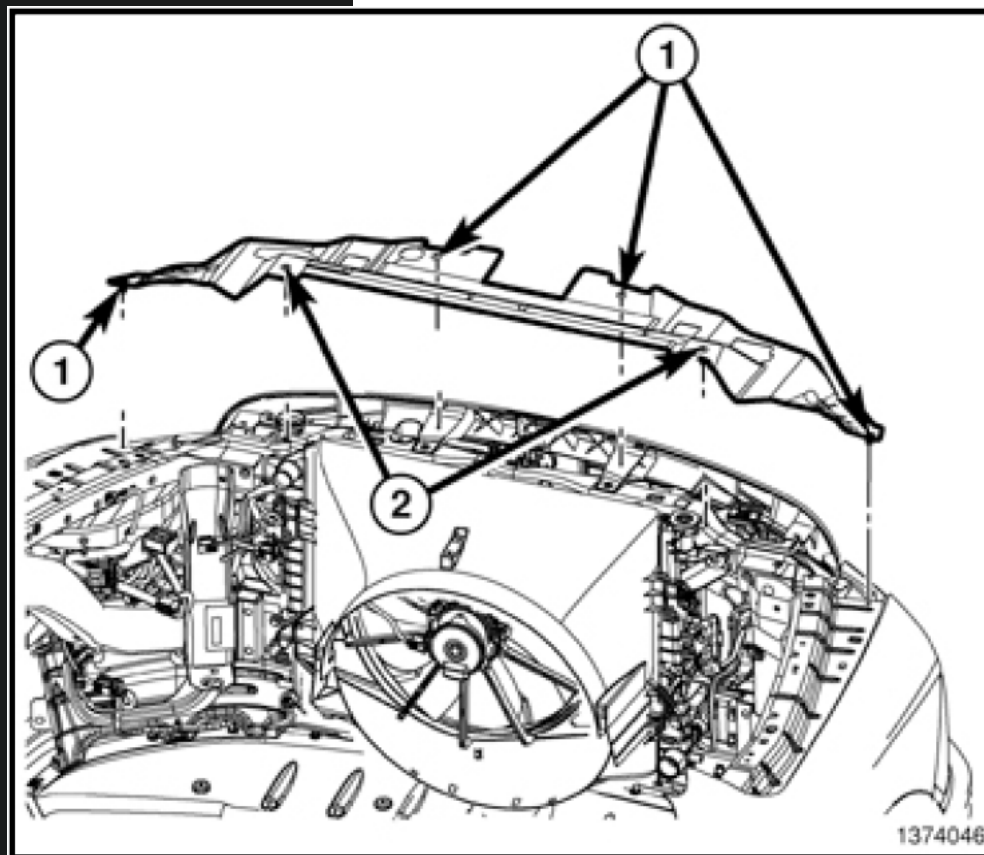

Locate and remove the four push pins indicated above (1) with a plastic fastener remover. Also remove the two plastic rivets (2) holding down the radiator seal with a plastic fastener remover. Pull the radiator seal away from the vehicle and set aside.

INSTALLATION INSTRUCTIONS OPEN FENDER SYSTEM

Product Number: TF2900

Application: 2016 DODGE RAM 2500

2

Removing grille supports

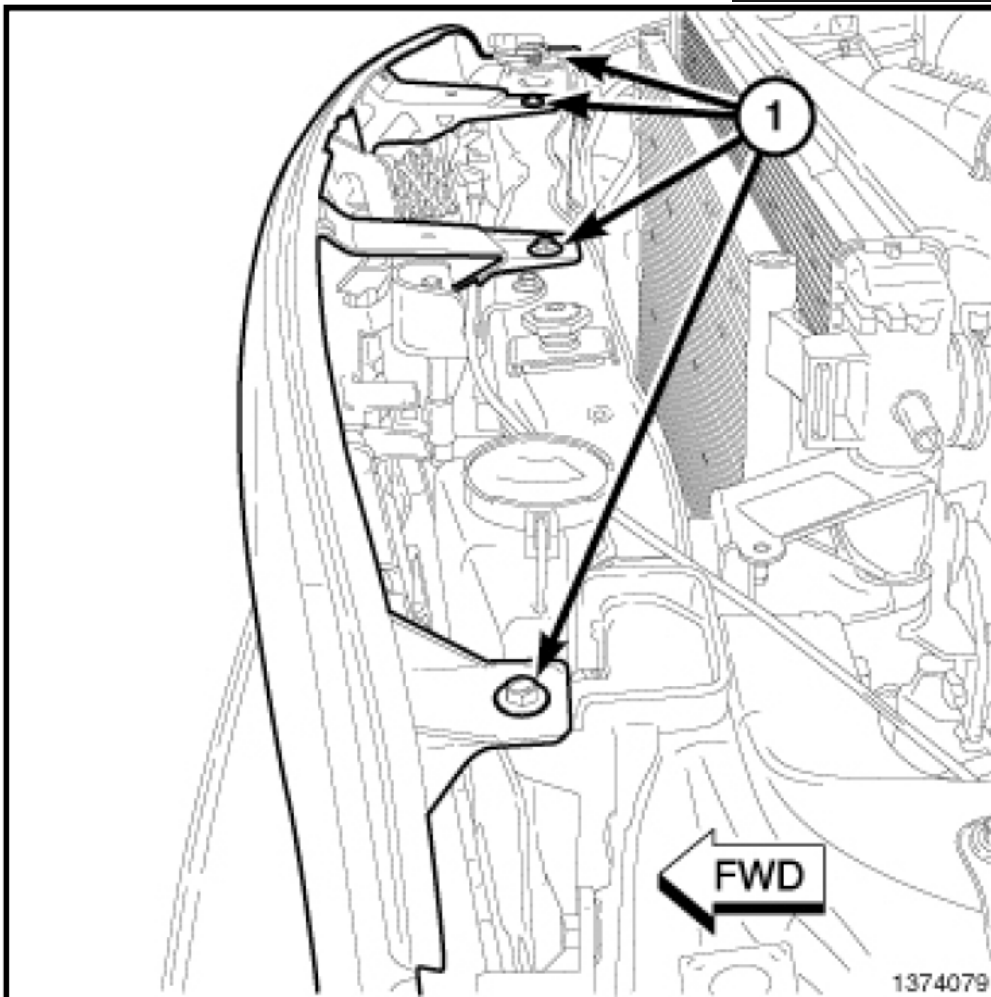

Using a 10mm socket, remove the four upper support bolts for the grille.

CHAPTER 2

DISASSEMBLY & PREPARATION

3

Removing grille

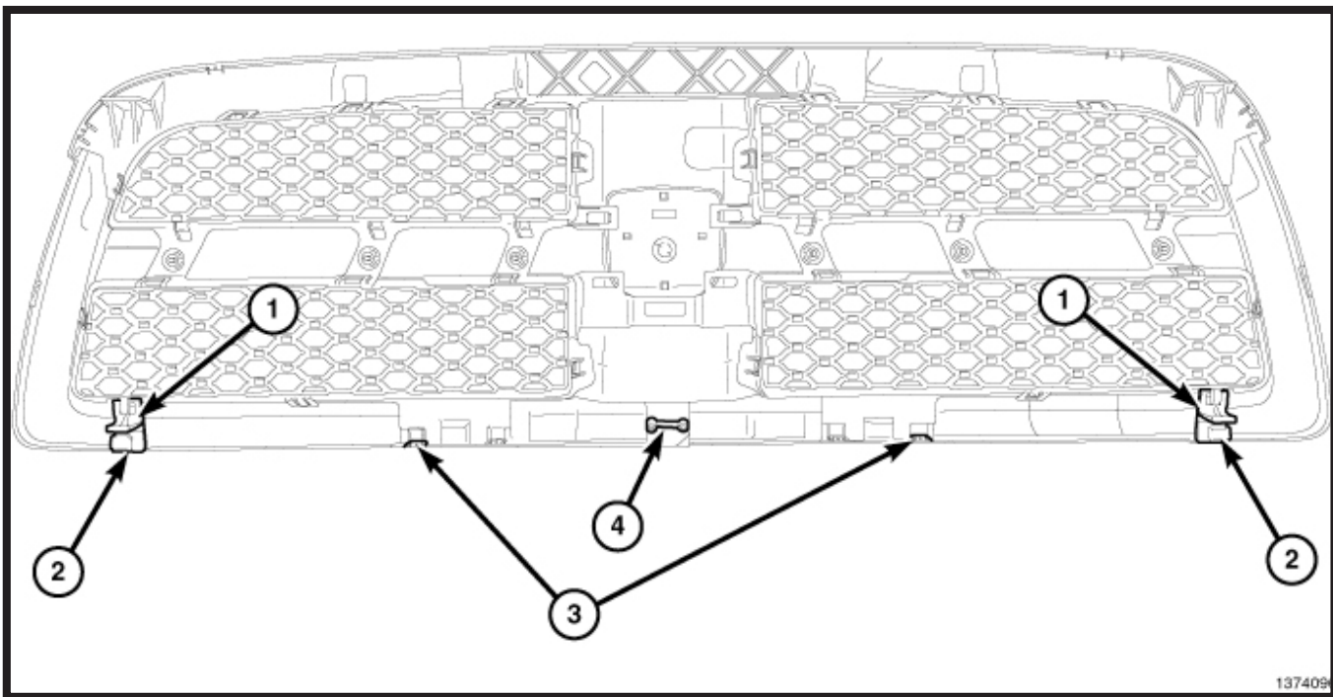

Separate the two lower spring clips (2) using a plastic fastener remover. Disengage the two lower hooks (1). Pull the grille away and set aside.

INSTALLATION INSTRUCTIONS OPEN FENDER SYSTEM

Product Number: TF2900

Application: 2016 DODGE RAM 2500

1

FRONT FASCIA REMOVAL

Removing wheelhouse splash shield

Note: the following steps are to be executed on both sides of the vehicle

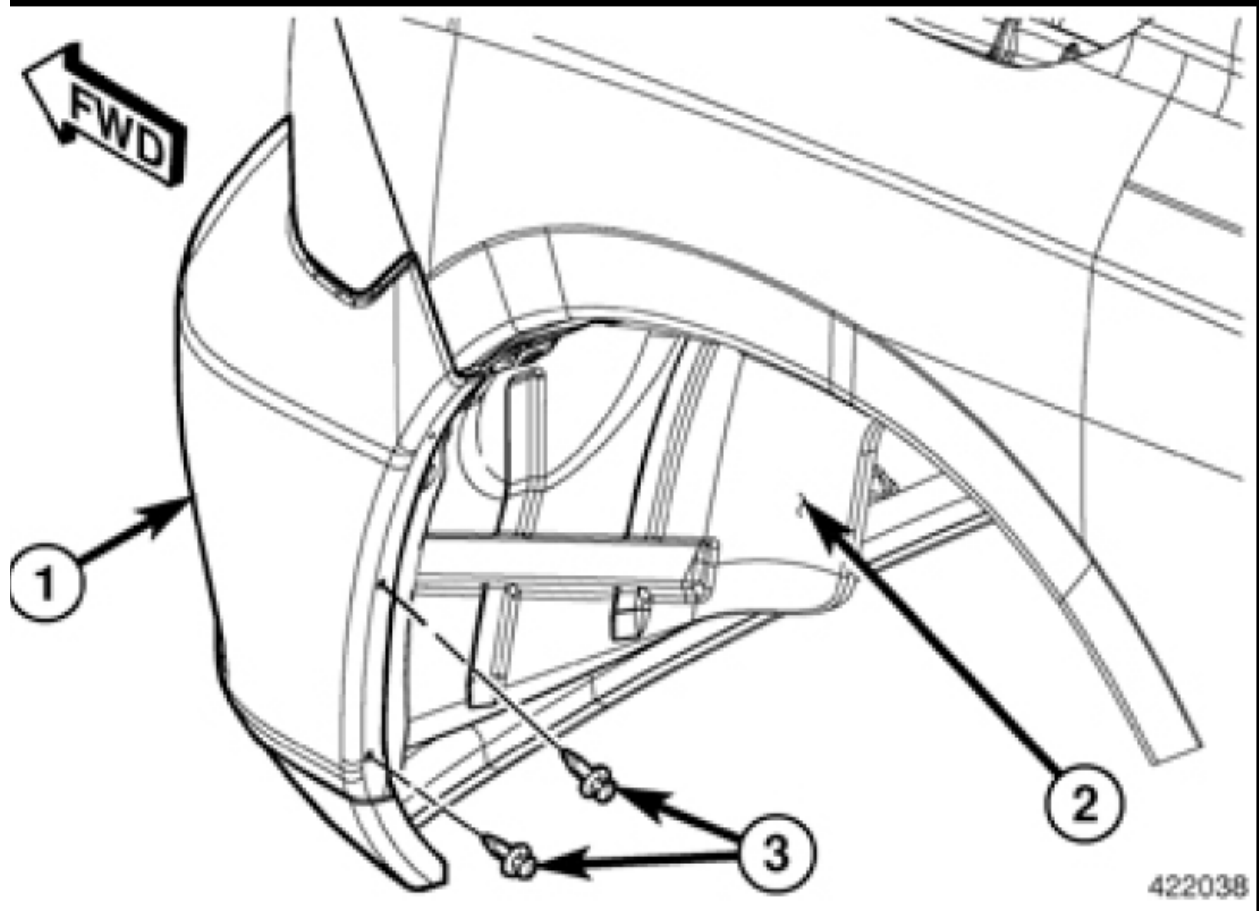

Remove the push pins with a plastic fastener remover and pull away wheelhouse splash shield; set shield aside.

CHAPTER 2

DISASSEMBLY & PREPARATION

2

Removing fender screws

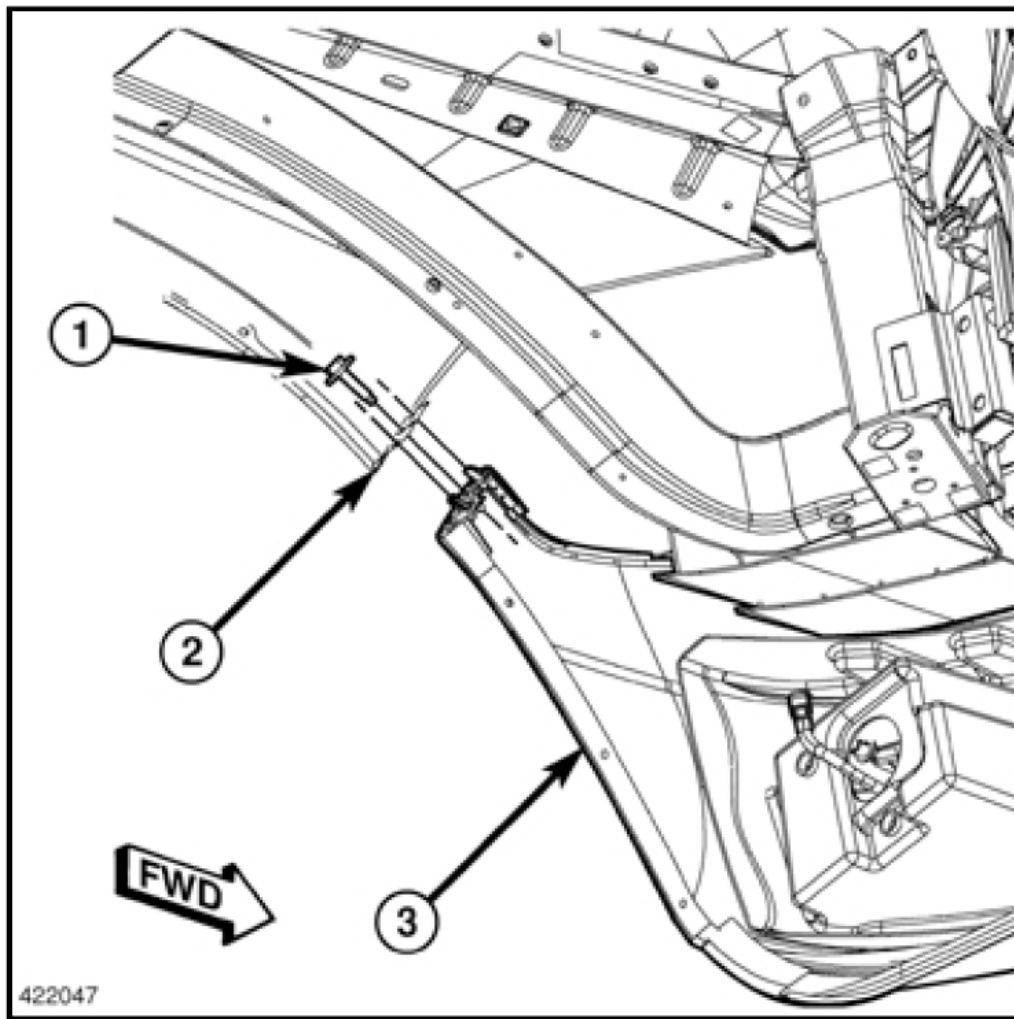

422047

Locate the fender screws as shown above; remove fender screws with a $\frac{1}{2}$ " socket.

INSTALLATION INSTRUCTIONS OPEN FENDER SYSTEM

Product Number: TF2900

Application: 2016 DODGE RAM 2500

3

Removing front fascia

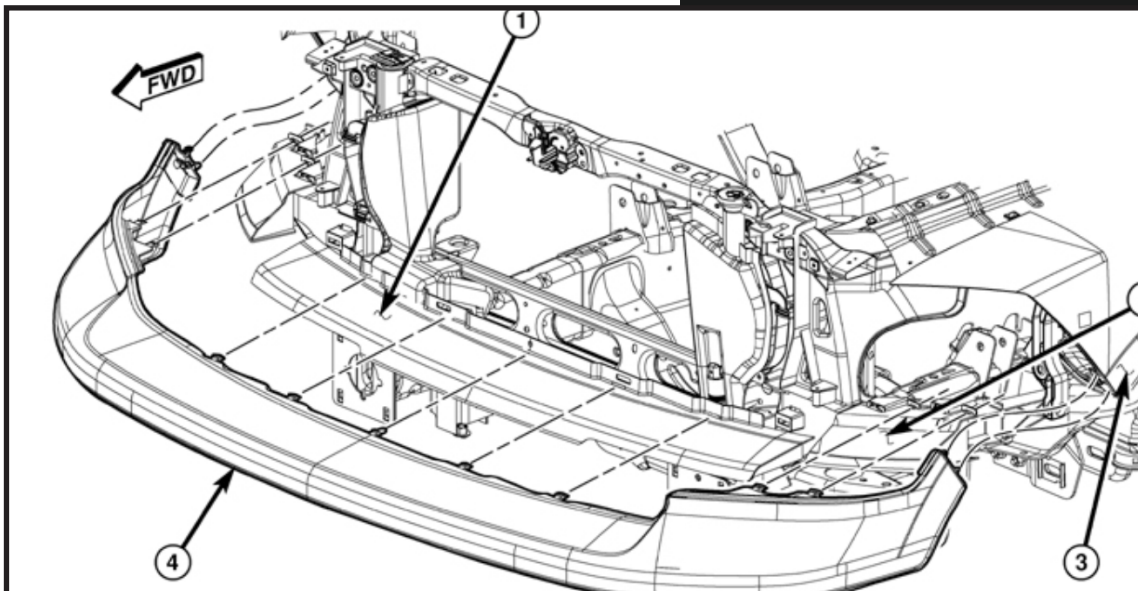

Use a plastic fastener remover to separate the upper clips and remove the fascia (4); set aside.

CHAPTER 2

DISASSEMBLY & PREPARATION

FENDER REMOVAL

1

Removing radio antenna and headlamp unit

Note: the following steps are to be executed on both sides of the vehicle

Remove the radio antenna from the passenger side of the vehicle as shown at left. Remove the front headlamp units as well.

Open the front door to access the rear upper screw (1) and remove with a 10mm socket; remove this screw on both sides of the vehicle.

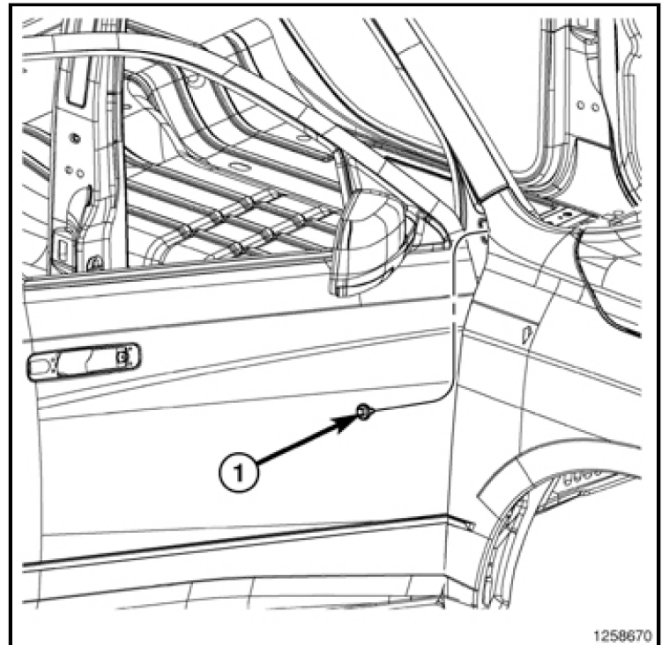
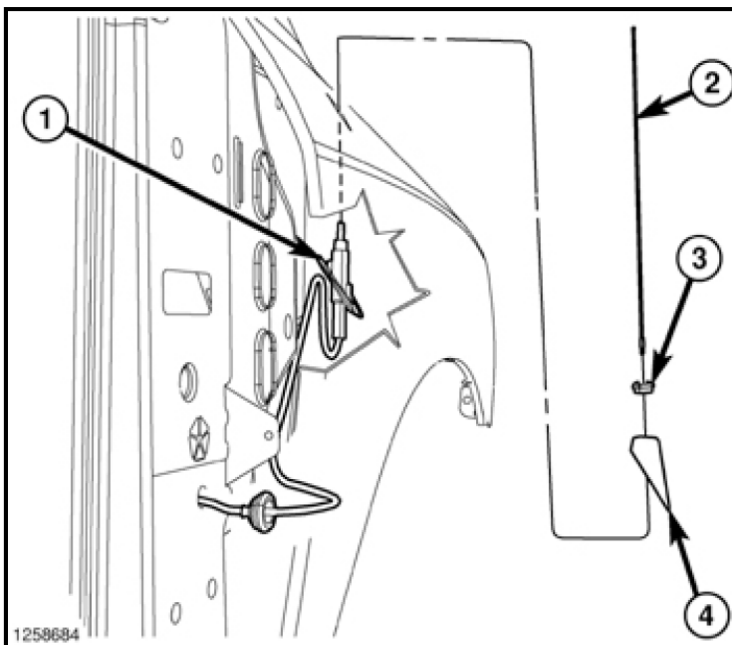

INSTALLATION INSTRUCTIONS OPEN FENDER SYSTEM

Product Number: TF2900

Application: 2016 DODGE RAM 2500

2

Removing front fender

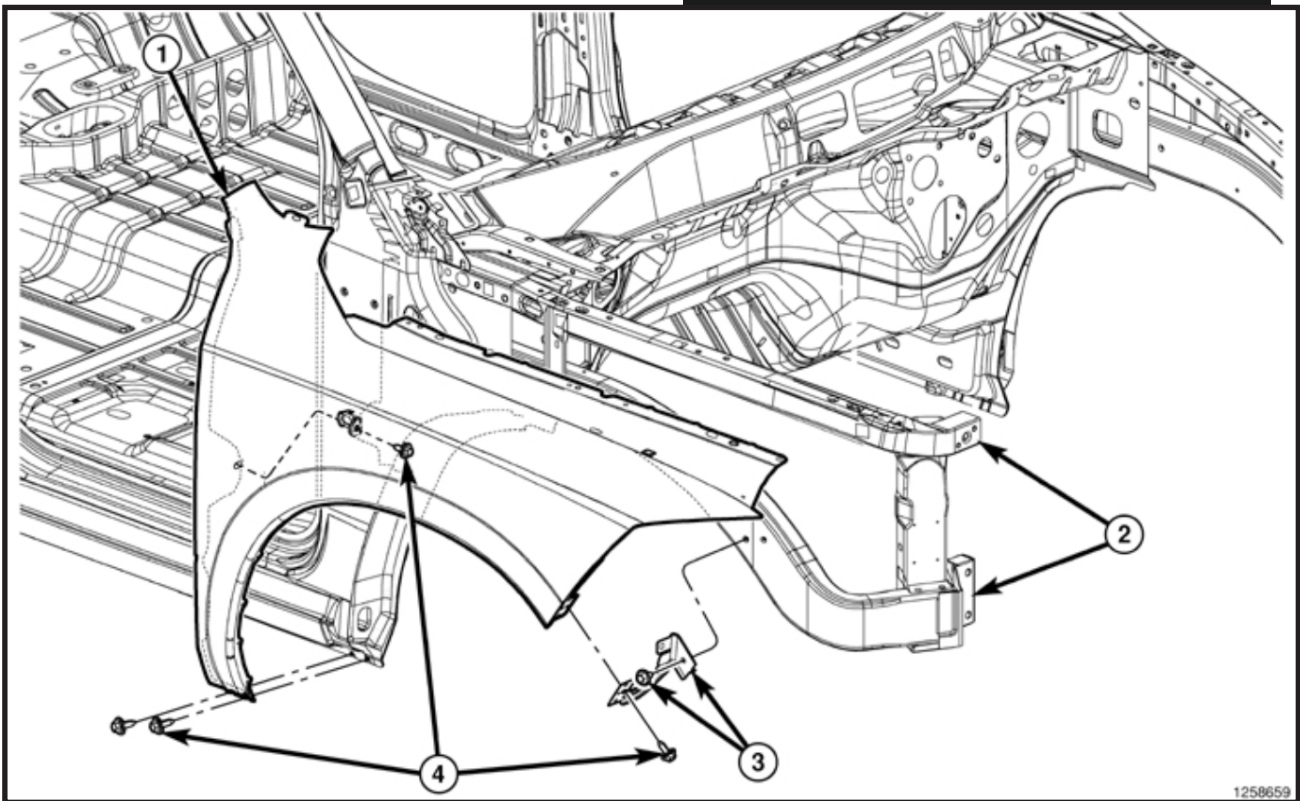

After removing the front wheel opening molding, remove the support screws (4) shown above with a ½" socket.

CHAPTER 2

DISASSEMBLY & PREPARATION

3

Removing front wheel opening molding and splash shield

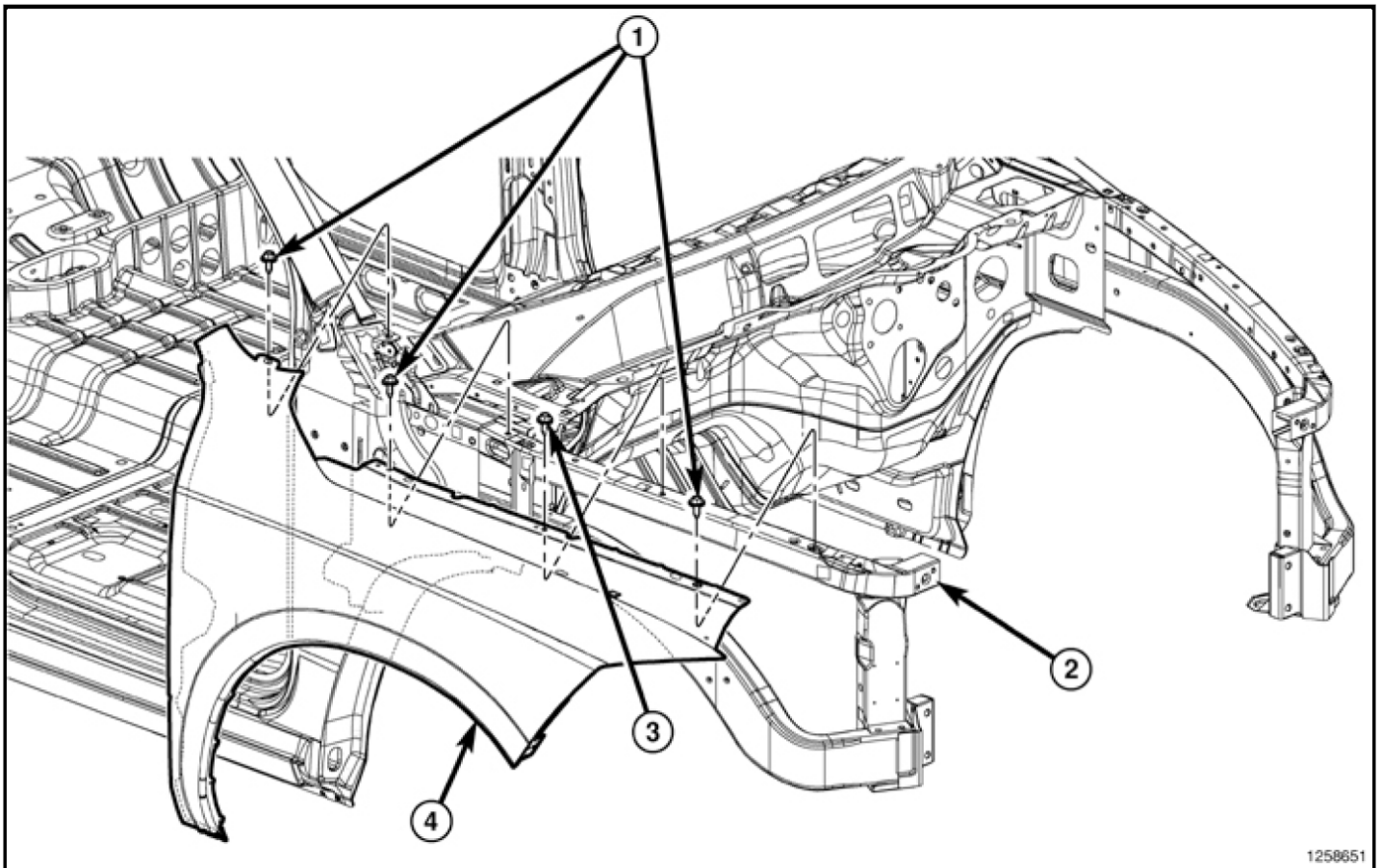

1258651

Remove the bolts attaching the fender to the frame at the top (1) with a 10mm socket; also unfasten the larger bolts (1) holding the battery cradle with a ½" socket. Pull the fender away from the vehicle and set aside.

INSTALLATION INSTRUCTIONS OPEN FENDER SYSTEM

Product Number: TF2900

Application: 2016 DODGE RAM 2500

CHAPTER 3

TEMPLATE MOUNTING



CHAPTER 3, SEC:1

Note: all surfaces should be cleaned before installing templates.

1

Installing fender templates.

Cut Template 1 (DS_CAB_1) is installed on the outside face of the rocker channel below the driver's side door. Start laying up the template at the bottom edge where the note says. Continue rolling the template upwards, closely following the contour at the edge of the application surface. Smooth out carefully making sure to remove any bubbles or wrinkles that may form. Draw a line with permanent marker connecting the two parts of the contour, following the path seen in the picture at left (see red oval).

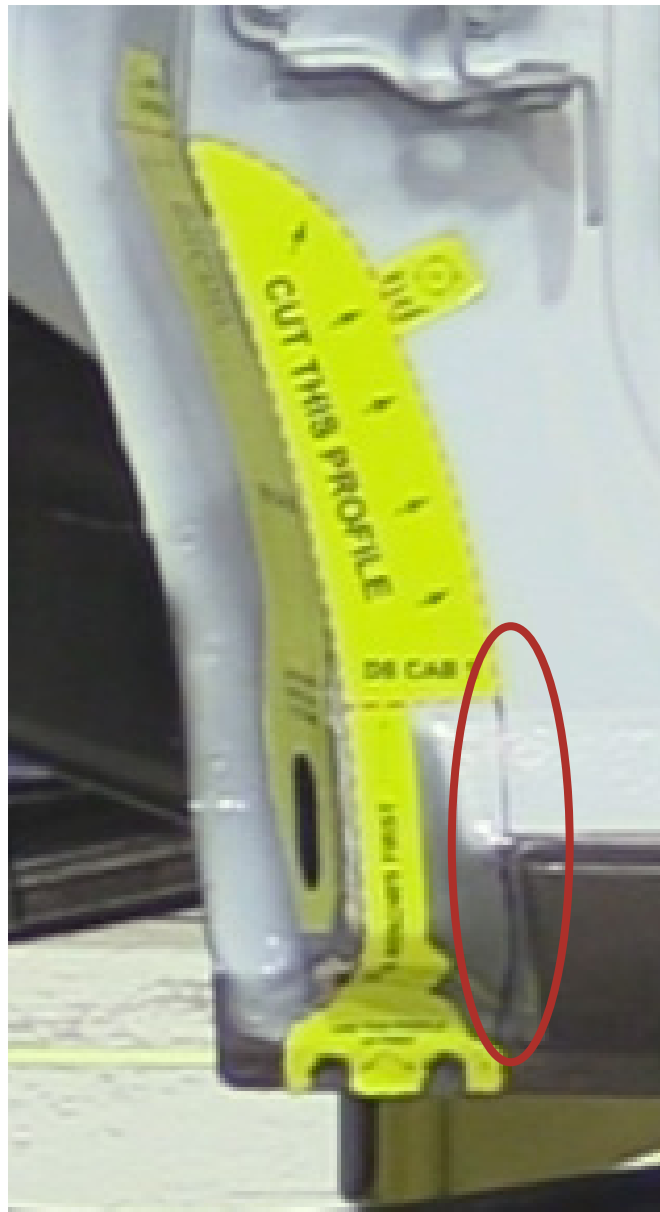

INSTALLATION INSTRUCTIONS OPEN FENDER SYSTEM

Product Number: TF2900

Application: 2016 DODGE RAM 2500



Cut Template 2 (DS_CAB_2) is applied to the front of the rocker channel as shown. Place the large oval cutout over the large oval hole on the rocker surface, starting on one side and smoothing around the hole. Roll the template upwards using the outboard edge of the surface as a guide for the template edge.

Using a T-square, align one axis of the square up with the outside surface of the truck so that the measuring axis is applied across the width of DS_CAB_2. The distance from the outboard surface to the hole location (crosshairs) should be $2 \frac{1}{16}'' \pm 1/16''$; if it is not, make a mark on the horizontal axis of the crosshairs that represents that distance. This location is where your $\frac{1}{2}''$ diameter hole will be drilled.

Cut Template 3 (DS_CAB_3) is applied to the inner-most face of the rocker channel. Start by placing the large oval cutout over the large oval hole in the rocker surface as shown, starting on one side and smoothing around the hole. Roll the template upwards and to the side, using the other holes in the surface and template as guides. NOTE: the secondary locating holes may not match up 100%. Try to match those holes to the best of your abilities.

CHAPTER 3

TEMPLATE MOUNTING

Note: all surfaces should be cleaned before installing templates.

Installing fender templates cont...

Cut Template 5 (DS_CAB_5) is placed on the same surface, directly above DS_CAB_3. Begin placing template at the narrow, upper end of the template making sure to place blue, hashed contour line along outer edge of surface as shown. Roll template across surface carefully smoothing out any bubbles or wrinkles that may form.

Cut Template 4 (DS_CAB_4) is placed on the driver side body mount next to the rocker channel. Start by placing the corner with the small circular cutout on the small circular hole in the body mount, carefully lining up the template contours with the edges of the body mount coming off of the corner. Smooth to the left and right, then take remaining template material (flap) and smooth it over the step in the body mount.



INSTALLATION INSTRUCTIONS

OPEN FENDER SYSTEM

Product Number: TF2900

Application: 2016 DODGE RAM 2500



Cut Template 6 (DS_FEN_1) is placed on the valence piece from directly below the headlight. Starting on the end of the part (where the locating pegs protrude from), match template edges to cutout edges on face of part, then roll the template around to the front face. Roll the remaining tab around the bottom edge to complete placement.

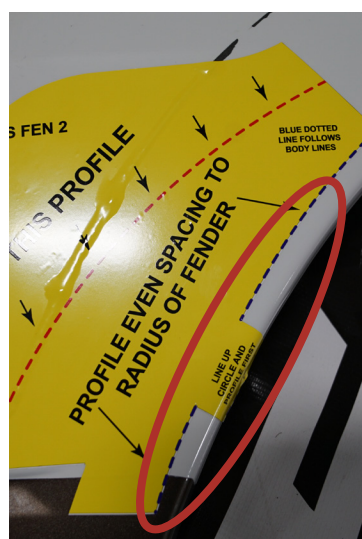
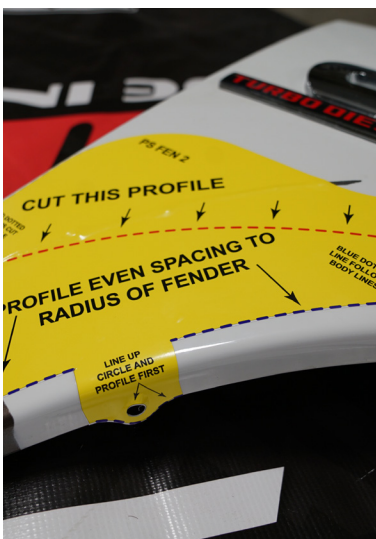

Cut Template 7 (DS_FEN_2) is placed on the front driver side fender as shown. Start by placing the locating hole indicated on the template on the last inner fender mount hole closest to the door. Match the tab contour to the contour around the hole and roll the rest of the template up over the radius. Carefully smooth template out to flat taking care to match the blue, hashed contour line to the curvature of the fender (see red oval).

CHAPTER 3

TEMPLATE MOUNTING

Installing fender templates cont...

Cut Template 8 (DS_FEN_3) is placed beside DS_FEN_2 and will follow the same fender contour, basically continuing the previous template. Start by placing the oval-shaped locating hole on the oval inner fender mount hole around the middle of the fender as shown. Again, take care to match the template contour to the contours around the mount hole, then roll the template upwards. Take care to match the blue, hashed contour line with the overall fender curvature. Continue to lay the template up, smoothing out any bubbles or wrinkles that may form.



INSTALLATION INSTRUCTIONS OPEN FENDER SYSTEM

Product Number: TF2900

Application: 2016 DODGE RAM 2500



Cut Template 9 (DS_FEN_4) is placed beside DS_FEN_3 and continues the previous cut template. Start by placing the circular locating hole on the third-from-front inner fender mount hole as shown. Again, take care to match the template contour to the contours around the mount hole, then roll the template upwards. Take care to match the blue, hashed contour line with the overall fender curvature. Continue to lay the template up, smoothing out any bubbles or wrinkles that may form.

*At this time, draw a line between the endpoints of the red, hashed cut lines with a straight edge and permanent marker. Also, extend the red, hashed cut line on DS_FEN_4 to the end of the fender surface.

CHAPTER 3

TEMPLATE MOUNTING

Installing fender templates cont...

Cut Template 10 (DS_FEN_5) is placed on the rear fender, forward of the rear axle. Starting from the bottom, place the locating hole on the mount hole for the structural rod taking care to match the blue, hashed contour lines on the template with the lower fender edges. Carefully smooth the template upwards, making the template edge follow the fender curvature. When you get to the top of the template, roll the tab inboard and place secondary locating hole on the closest inner fender mount hole.

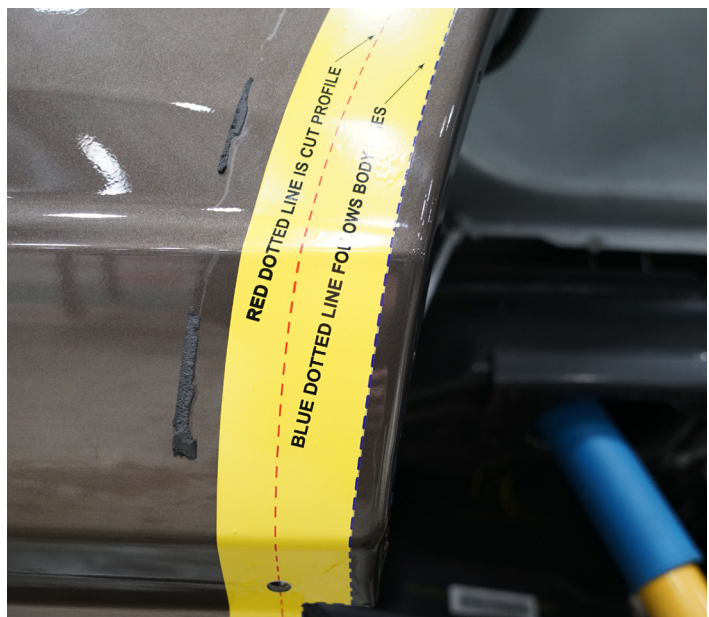

INSTALLATION INSTRUCTIONS

OPEN FENDER SYSTEM

Product Number: TF2900

Application: 2016 DODGE RAM 2500

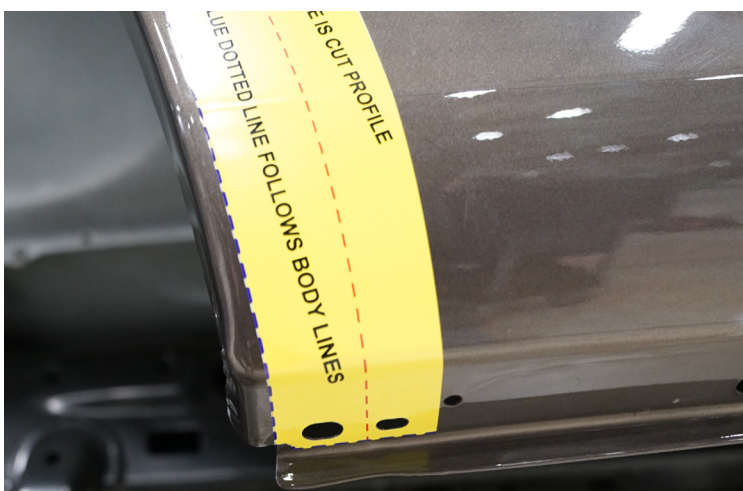

Cut Template 11 (DS_FEN_6) is placed on the rear fender, behind the rear axle. Starting from the bottom, place the two oval-shaped locating holes on the two oval-shaped holes. After smoothing out bottom area of template, roll the upper template portion upwards taking care to keep the blue, hashed contour line in line with the fender curvature. When you get to the top of the template, roll the tab inboard and place secondary locating hole on the closest inner fender mount hole.

NOTE: the secondary locating hole may not match up with the inner fender mount hole 100%. Place this hole as close to the mount hole as possible.

CHAPTER 4

CUTTING



CHAPTER 4, SEC:1

Note: All cuts are mirrors steps should be repeated on both sides of vehicle unless specified.

1

Cutting Cab / Rocker Channel

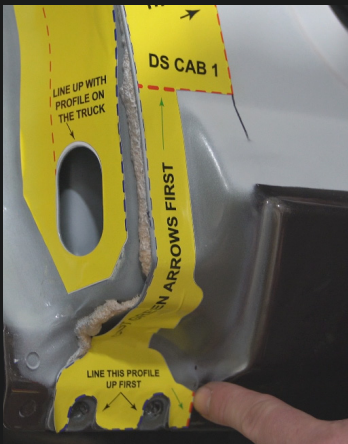

If you have not already done so, draw a line with permanent marker on the painted truck surface to connect the discontinuous cut profile on template DS_CAB_1 (see photos above). Also extend the horizontal hashed cut line around the corner to the edge of the body (see photos above). Cut upwards on the cut profile until you meet the horizontal cut profile in the middle of the template. Following that profile now from the outside edge, cut all the way across that cut profile; this final cut will disconnect a large chunk of the lower rocker channel.



NOTE: These cuts will be cutting through 4 layers of material so a larger blade may be preferred.

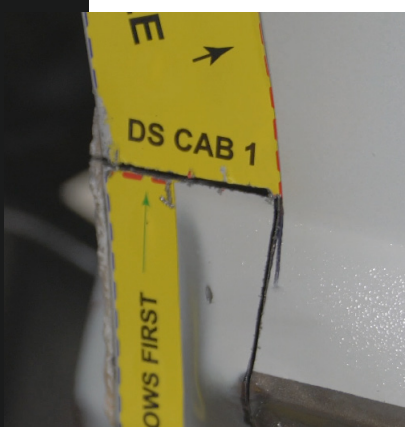

INSTALLATION INSTRUCTIONS OPEN FENDER SYSTEM

Product Number: TF2900
Application: 2016 DODGE RAM 2500



On template DS_CAB_1, cut upwards following the curved profile using a small body saw to accommodate the curvature. There is a solid plate behind the upper portion of the cut region so you may need to finish off the cut with a cutoff wheel. Switching to template DS_CAB_2, cut the upper horizontal profile on with a cutting wheel moving from outboard to inboard until you reach the red, hashed vertical cut profile on the same template. Start at the bottom of DS_CAB_2 and cut the vertical hashed red cut profile in the middle of the template until you reach the upper horizontal cut profile. This final cut will free another large chunk of the rocker channel area.



NOTE: You may need to use the cutting wheel to finish off other cuts because of the solid plate mentioned above.



CHAPTER 4

CUTTING

Cutting Cab / Rocker Channel cont...



INSTALLATION INSTRUCTIONS OPEN FENDER SYSTEM

Product Number: TF2900

Application: 2016 DODGE RAM 2500

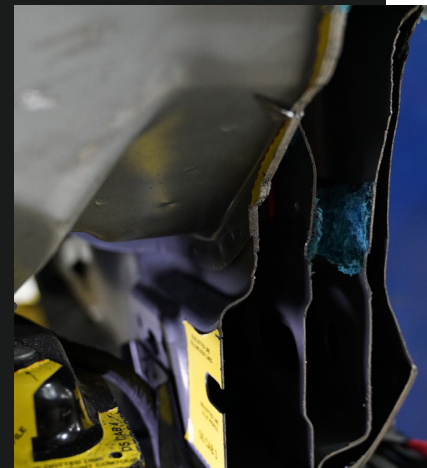
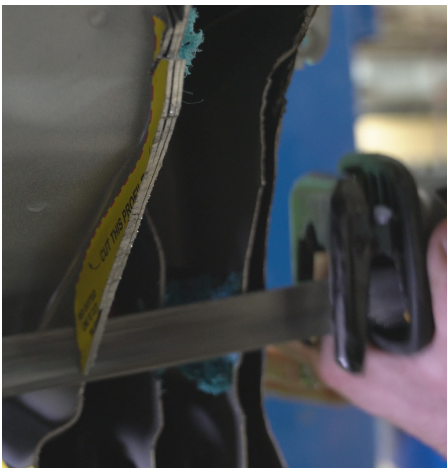

At this point, begin to notch pieces out of the rocker channel as shown. Take care that you DO NOT cut past the red, hashed cut profiles on the inner templates – DS_CAB_3 & DS_CAB_5. This notching operation serves to chip away at the truck material so that it is easier to follow those inner contours.

Cut across the rest of the upper horizontal cut profile on template DS_CAB_2; use a cutoff wheel for this operation as there is a thick layer of material to cut through. Keep cutting away at the intermediate layer of metal to expose the inboard-most layer of metal. At this point, the outer 3 layers (including the outboard layer) should look as if they were cut along the same contour if viewed from the side of the truck.

Cut the interior template DS_CAB_5 by notching out sections up to the cut line. As you will not be able to see where you are cutting, notching is the most careful way to proceed. Err on leaving more material as cutting too deep would expose the cab. Clean up with a grinder any rough edges left from cutting. Use a flapper wheel to carefully remove any more material to the cutting line on DS_CAB_5.

CHAPTER 4

CUTTING



CHAPTER 4, SEC:2

2

Cutting Body Mounts

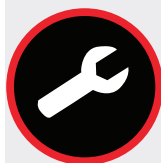

With a body saw, or other appropriate tool, cut template DS_CAB_4 from front to rear, moving from inboard to outboard in relation to the vehicle.

On the passenger side follow the same procedure with template PS_CAB_4, moving from front to rear, inboard to outboard in relation to the vehicle.

INSTALLATION INSTRUCTIONS

OPEN FENDER SYSTEM

Product Number: TF2900

Application: 2016 DODGE RAM 2500



CHAPTER 4, SEC:3

3

Cutting Rear Fenders



Before cutting DS_FEN_5, make sure that the bolt for the reinforcement rod has been removed; the cut profile on this template bisects this bolt hole in the fender surface.



DO NOT CUT THE REINFORCEMENT ROD! Using a cut-off wheel (or other appropriate tool), begin at the bottom of the template and cut upwards. Continue cutting past the end of the cut profile, roughly continuing that arc until you reach the inside edge of the fender.

When cutting DS_FEN_6, start from the bottom with a body saw, (or other appropriate tool), and cut upwards. Again, continue cutting past the end of the cut profile, roughly continuing that arc until you reach the inside edge of the fender.

CHAPTER 4

CUTTING



CHAPTER 4, SEC:4

4

Cutting Front Fenders

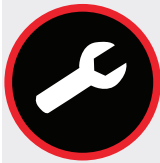

Before cutting the front fenders, draw a line between the endpoints of the red, hashed cut lines with a straight edge and permanent marker. Also, extend the red, hashed cut line on PS_FEN_4 to the end of the fender surface.

Beginning at the door-end of the fender and using a body saw, (or other appropriate tool). cut along the horizontal portion of the cut profile. Continue that cut toward the inner part of the fender. This cut will remove a large portion of the lower fender.

Now, continue cutting on the original cutting line following the arcs of the cut profile and your hand-drawn cut lines. Continue to the end of the fender surface.



*Clean up edges with a [flapper wheel, grinder, etc...]

INSTALLATION INSTRUCTIONS OPEN FENDER SYSTEM

Product Number: TF2900

Application: 2016 DODGE RAM 2500



CHAPTER 4, SEC:5

5

Cutting Headlight Valence Bracket



Using a body saw (or other appropriate tool), cut through the part at the template DS_FEN_1 cut line beginning on the narrower side. The cut should look as if a plane separated the two pieces.

Follow the same procedure for cutting the opposite side (PS_FEN_1). At this point, apply rust trap to all bare metal edges and surfaces that were exposed during cutting process.

CHAPTER 5

INSTALLATION -
ROCKER CHANNEL PLATES



CHAPTER 5, SEC:1

1

Installing Seam Bracket

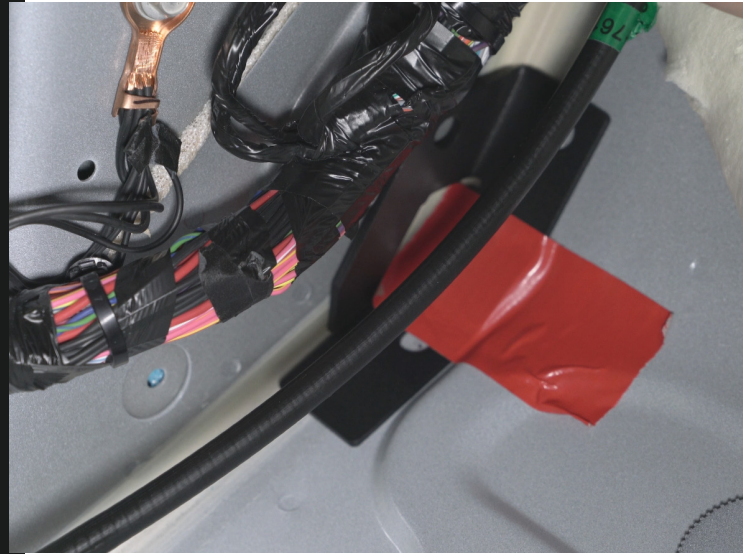

INSTALLATION INSTRUCTIONS

OPEN FENDER SYSTEM

Product Number: TF2900

Application: 2016 DODGE RAM 2500

Peel the front seat carpet and insulation back towards the center console to expose the metal floor of the cab. Using a plastic fastener remover, remove the plastic fasteners holding the bundle of wires to the inside side of the cab floor.

Be careful to pull back these wires to keep them clear of any drilling. Slide the seam bracket along corner where the floor and wall meet until it settles into place; you will feel how the bracket is supposed to sit in the contour of the floor.

Once the part location is reached, apply duct tape to keep it in place. Mark holes with a permanent marker, then remove the bracket and use a center punch on each hole location. Starting with a 1/8" bit, drill holes for the bracket.



CHAPTER 5

INSTALLATION - ROCKER CHANNEL PLATES

Installing Seam Bracket cont...

Now, from the outside, step up to 3/8" holes. Again, take care not to clip any of the wires on the interior of the truck. Apply rust trap to every cut/drilled edge and allow to dry.

Mount bracket with the hardware specified. Use the YZ hardware for the side hole (bolt head on interior); use the SS hardware for the two floor holes (bolt head on exterior).



SEAM BRACKET INSTALLATION HARDWARE: (PER SIDE)

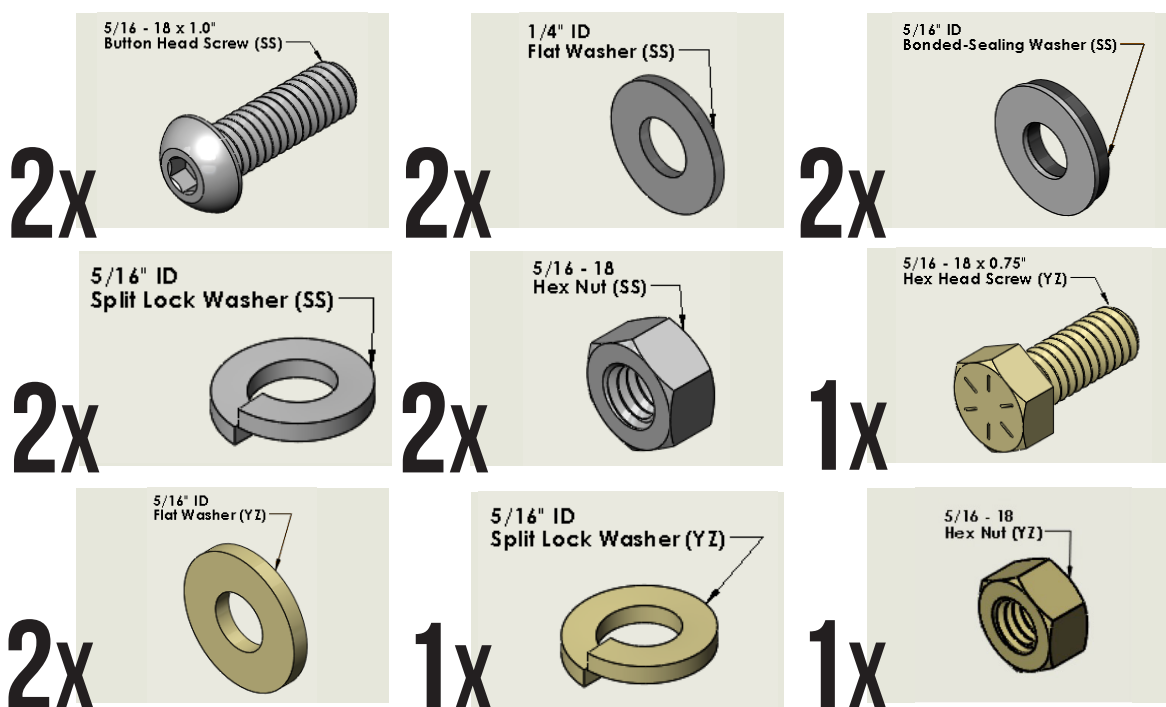

INSTALLATION INSTRUCTIONS

OPEN FENDER SYSTEM

Product Number: TF2900

Application: 2016 DODGE RAM 2500



CHAPTER 5, SEC:2

2

Installing Rocker Channel Plates



Drill $\frac{1}{2}$ " holes on remaining template pieces on rocker channel stepping up from a $\frac{1}{8}$ " bit to full size. For the hole on the outer surface of the truck, cut back the region around the hole on the NEXT LAYER inboard with respect to the truck (indicated on photo). Cut and grind any of these inner layers as much as needed to get the parts to slide into position correctly.



DO NOT CUT MORE OF THE OUTER LAYER. Apply rust trap to every cut/drilled edge and allow to dry.

Install the upper rocker channel plate first, then fasten the lower rocker plate to the upper using the slot on the lower plate. Use this slot for adjustment. Push the lower portion of the lower plate against the cut surfaces to close the gap as best you can. Have a partner drive in the $\frac{1}{4}$ " drill tip screw into the bottom hole.

CHAPTER 5

INSTALLATION - ROCKER CHANNEL PLATES

Installing Rocker Channel Plates cont...



ROCKER CHANNEL PLATE INSTALLATION HARDWARE: (PER SIDE)

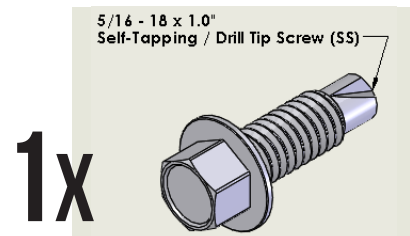
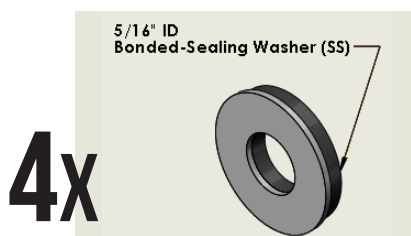

INSTALLATION INSTRUCTIONS OPEN FENDER SYSTEM

Product Number: TF2900

Application: 2016 DODGE RAM 2500



CHAPTER 5, SEC:3

3

Installing Sealing Foam in Rocker Channel



Remove the rocker plates and set aside. From the blue, foam packing material that came with this product, cut sections out like the ones in the photo to the left. Insert these foam pieces into the rocker channel as shown. These pieces will block the foam from pushing back into the rocker channel and direct the foam upward into the upper part of the channel.



Re-install the rocker channel plates. Cover all exposed gaps or edges with duct tape to seal the foam inside the channel. Using the hole shown, insert the foam into the rocker channel cavity. Wait for the foam to expand. Remove tape, then grind/sand any protruding edges very carefully.



CHAPTER 6

INSTALLATION - FENDER BASES



CHAPTER 6, SEC:1

Note: All cuts are mirrors steps should be repeated on both sides of vehicle unless specified.

1

Installing Rear Base Fenders



Apply seal to outside edge of rear base fender as shown in Appendix A. With the help of another person, lay up the rear base fender making sure that the lower mounting slots are lined up with their respective holes (you may have to pull/push the base fender while another person puts the bolts through). Clamp base to fender at the top middle, and the sides as shown. Install bolts in lower mount points, using the OEM bolt and the stabilizer rod to fasten the forward end, and using the 1/4" SS hardware specified above for the back end.



Once the lower bolts are in, make sure that the rest of the fender looks correct and there is no interference. Now, use an appropriately sized center punch to mark your bolt holes.



INSTALLATION INSTRUCTIONS OPEN FENDER SYSTEM

Product Number: TF2900

Application: 2016 DODGE RAM 2500



Remove fender completely from side of truck and set aside. Stepping up from a 1/8" bit, drill 3/8" diameter holes at every location marked with the centerpunch (10 holes total). Apply rust trap to every cut/drilled edge at this point and allow to dry.

Place fender back on the truck, this time loosely bolting the two holes in the top center to hold the base up. Install the rest of the hardware, noting that the curved nut plates are used for holes 3 & 4 and 7 & 8 as indicated.



NOTE: Nut plates are NOT identical but ARE interchangeable. Also, make sure curve follows same contour as fender base.

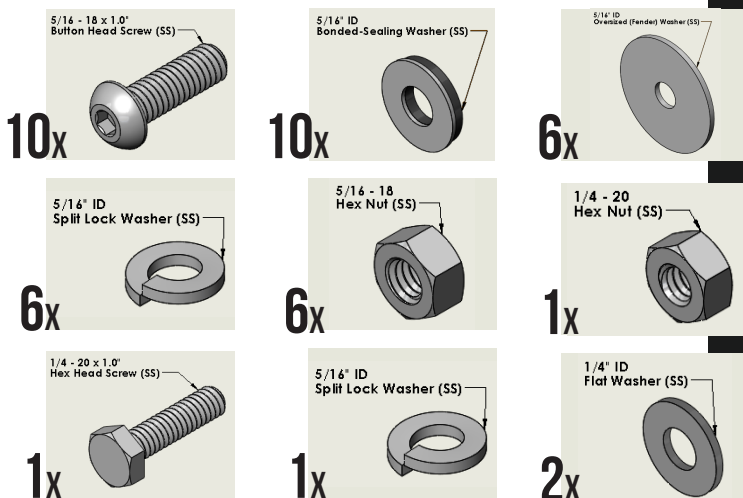

**REAR BASE
INSTALLATION HARDWARE:
(PER SIDE)**

CHAPTER 6

INSTALLATION - FENDER BASES



CHAPTER 6, SEC:2

2

Installing Front Upper Bracketry

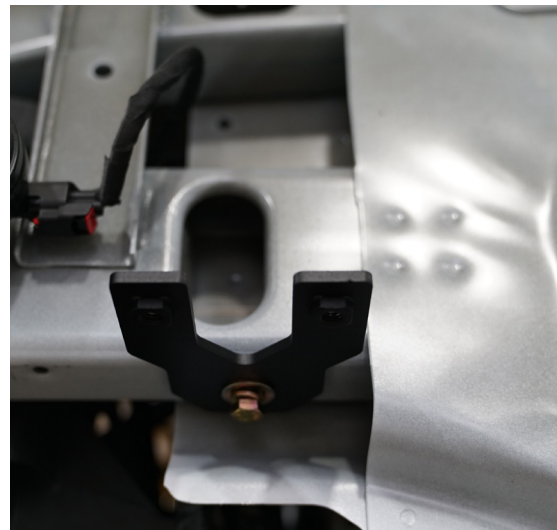

FRONT UPPER BRACKETRY INSTALLATION HARDWARE (PER SIDE)

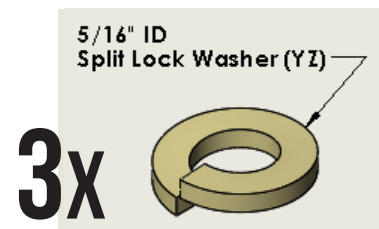
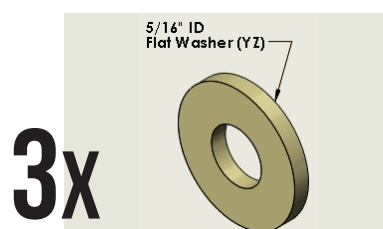
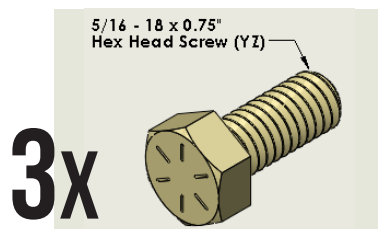

INSTALLATION INSTRUCTIONS OPEN FENDER SYSTEM

Product Number: TF2900

Application: 2016 DODGE RAM 2500



Place the bracketry template DS/PS_BRKT_1 on the frame of the truck as shown. Drill through indicated hole location, stepping up from a 1/8" bit to 3/8" diameter. Apply rust trap to every cut/drilled edge and allow to dry. Lay small nut plate inside of the tubing as shown and use the hardware specified to fasten it to frame.

Now, fasten the larger bracket part to this part with the rest of the hardware specified; be careful to orient this larger bracket correctly. Later, you may need to adjust the position of these brackets so leave the bolts only hand tight.

CHAPTER 6

INSTALLATION - FENDER BASES



CHAPTER 6, SEC:3

3

Installing Front Base Fenders



Apply seal to front base fenders as shown in Appendix A. With OEM fender and valence bracket still off the truck, bolt the two together and set on flat surface. Lay front fender base on OEM fender. Line up the back end of the base fender with the door end of the OEM fender, making outer edge of seal flush with the edge of the OEM fender; also line up the forward, horizontal edge of the base fender with the horizontal contour of the valence bracket, making the two edges flush. Carefully clamp into place on OEM fender body.



Use an appropriately sized centerpunch to mark each hole (7 holes total). Remove base fender from OEM fender and set aside. Starting with a 1/8" drill bit, step up to 3/8" diameter holes. Apply rust trap to every cut/drilled edge and allow to dry.



NOTE: Drill all the way through valence bracket part. Turn over part to expose backside and extend hole to cut edge; basically, notch out a long, open-ended slot to allow space for holding a nut.



INSTALLATION INSTRUCTIONS OPEN FENDER SYSTEM

Product Number: TF2900
Application: 2016 DODGE RAM 2500



Re-install OEM parts on front end of truck. Bolt the fender base to the OEM fender with the specified hardware using the upper bracketry installed in the previous section and holes 3 and 4. Continue installing the rest of the bolts in holes 1, 2 5, 6, and 7.

NOTE: To install bolt in hole 1, you must insert the nut and flat washer into the channel previously cut into the backside valence bracket.

Install the oblong bracket shown in the picture to the left by bolting through to the nut plate attached to the lower portion of the fender base. The other end of this bracket is fastened to the rocker channel plate. Use the slots on this bracket to bring the lower, outer edge of the fender base in line with the rest of the truck body (when the doors are re-installed).

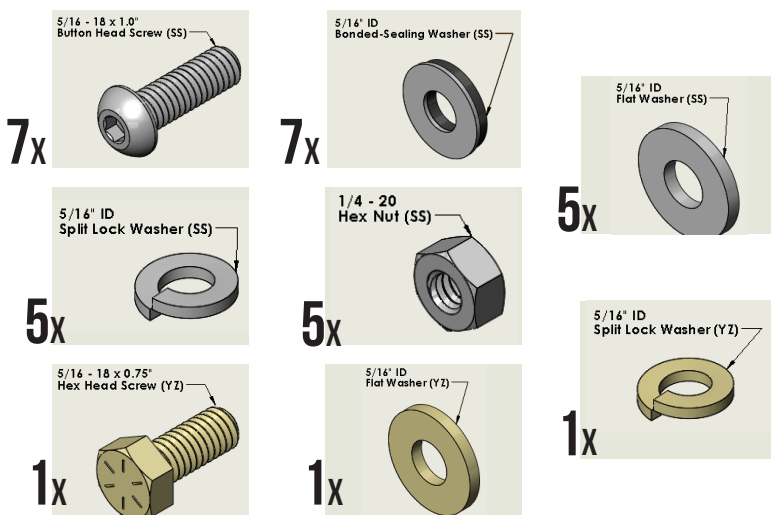

**FRONT BASE
INSTALLATION HARDWARE:
(PER SIDE)**

CHAPTER 7

INSTALLATION - INNER FENDER



CHAPTER 7, SEC:1

1

Installing Inner Fender Hardware



The inner fender will mount to two existing holes in the truck frame and one hole in the cab that will need to be created. Lift the inner fender into the wheel well and over the strut tower. Line up the upper bolt hole with the existing hole in the frame – to the left or right (depending on driver or passenger side) of the upper interior bracket installed in chapter 6 section 2. Have a partner use one of the thread-cutter bolts to drive into that hole (you should not need to widen the hole before installation). Do the same with the existing hole in the forward part of the frame; you may have to flex the inner fender a bit to make the holes line up.

The last bolt is a drill tip and installs into the outer cab surface as shown.



NOTE: If the drill tip screw does not install fully (if the part does not pull flush to the outer cab surface) there is another set of SS hardware to use for this hole. Remove the inner fender, peel back carpet and insulation, and install with a nut and washers.

INSTALLATION INSTRUCTIONS OPEN FENDER SYSTEM

Product Number: TF2900

Application: 2016 DODGE RAM 2500



- 1x Self-Tapping / Drill Tip Screw (SS)
- 2x Thread-Cutting Screw (SS)
- 1x Button Head Screw (SS)
- 1x ID Bonded-Sealing Washer (SS)
- 1x ID Flat Washer (SS)
- 1x ID Split Lock Washer (SS)

**INNER FENDER INSTALLATION
HARDWARE: (PER SIDE)**

CHAPTER 8

INSTALLATION - FENDER FLARE



CHAPTER 8, SEC:1

1

Installing Front Fender Flares

Note: All parts are mirrors steps should be repeated on both sides of vehicle unless specified.



Install seal on mounting edge of all flares. See Appendix A for install instructions if necessary. Insert bolts through slots in fender flare mounts and fasten into weld nuts on base fender. Bolt install points are indicated by red circles.



NOTE: The seal may start to pooch as you tighten the flare bolts. Be mindful of this and 'roll' the seal back into the proper position if this occurs.

INSTALLATION INSTRUCTIONS OPEN FENDER SYSTEM

Product Number: TF2900

Application: 2016 DODGE RAM 2500



Note: If you did not purchase flare parts, we have provided extra stainless steel washers and bolts to plug those mounting locations.

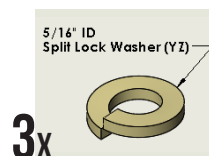
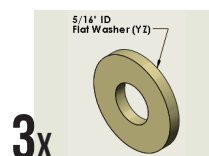
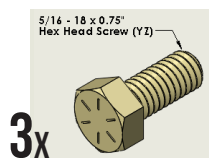

**FRONT FENDER FLARE
INSTALLATION HARDWARE:
(PER SIDE)**

CHAPTER 8

INSTALLATION - FENDER FLARE



CHAPTER 8, SEC:2

2

Installing Rear Fender Flares

Install seal on mounting edge of all flares. See Appendix A for install instructions if necessary.

Insert bolts through slots in fender flare mounts and fasten into weld nuts on base fender. Bolt install points are indicated by red circles.



NOTE: The seal may start to pooch as you tighten the flare bolts. Be mindful of this and 'roll' the seal back into the proper position if this occurs.



INSTALLATION INSTRUCTIONS OPEN FENDER SYSTEM

Product Number: TF2900
Application: 2016 DODGE RAM 2500



5/16 - 18 x 0.75"
Hex Head Screw (YZ)

3x

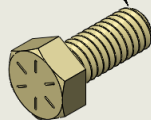

5/16" ID
Flat Washer (YZ)

3x



5/16" ID
Split Lock Washer (YZ)

3x



Note: If you did not purchase flare parts, we have provided extra stainless steel washers and bolts to plug those mounting locations.

**REAR FENDER FLARE
INSTALLATION HARDWARE:
(PER SIDE)**

APPENDIX 1

APPLYING SEAL

Apply seal to the end of one edge of the part. The seal has adhesive in the groove, so it should adhere firmly to the part. Now, run the seal the rest of the way around the part edge, pressing firmly to fully engage the adhesive and smoothing out any bumps that may occur.

When you reach the end of the part edge, cut the seal with scissors at an angle that roughly matches the geometry of the termination point, as shown. Always err on the side of leaving a bit more seal material to get the termination point cut just right.



CONTACT ---

FAB FOURS INC.

2213 INDUSTRIAL PARK ROAD

LANCASTER, SC 29720

PHONE: (866)-385-1905

FAX: (970)-385-1914

EMAIL: SUPPORT@FABFOURS.COM



*"If you're looking for more
of the same, then you've
come to the wrong place."*

- Greg Higgs

