



INSTALLATION MANUAL
MATRIX FRONT BUMPER
PRODUCT NUMBER: X395X
APPLICATION: 2019+ GMC1500



IMPORTANT SAFETY GUIDE | Your safety and the safety of others is very important.

In order to help you make informed decisions about safety, we have provided the following warnings, safety precautions, installation instructions, and other important information to alert you to potential hazards that could hurt you or others.

Please do a job safety analysis before each task to identify potential hazards for your situation and remove/protect against them. Use own good judgment and take your time.

Check packaged materials immediately upon arrival to ensure that all listed parts are included and undamaged.

Read and understand all warnings, safety precautions, and instructions before installing this product.

SENSORS FIELD OF VIEW WILL BE ALTERED WITH USE OF THE REPLACEMENT BUMPER.

WARNINGS

- Failure to observe the following warnings and instructions provided in this manual could lead to severe injury and/or death.
- For professional installation only. Careless installation and/or operation can result in serious injury, death, and/or equipment damage. All liability for installation and use rests with the user or consumer.
- Fab Fours, Inc. only approves installing this product according to these written instructions with the hardware provided. Failure to install according to these instructions will invalidate the warranty. This includes, but is not limited to, using alternative installation methods, hardware, or materials.
- This product is for off road use only.

SAFETY PRECAUTIONS

- Always remove jewelry and wear eye protection.
- Always use extreme caution when jacking up a vehicle for work. Set emergency brake and use tire blocks. Locate and use the vehicle manufacturers designated lifting points. Use jack stands.
- Always use appropriate and adequate care in lifting components into place.
- Always ensure components will remain secure during installation and operation.
- Always wear safety glasses when installing this kit. A drilling operation will cause flying metal chips. Flying chips can cause serious eye injury.
- Always use extreme caution when drilling a vehicle. Always disconnect power before welding. Thoroughly inspect the area to be drilled (on both sides of material when possible) prior to drilling, and relocate any objects that may be damaged.
- Always use extreme caution when welding a vehicle. Thoroughly inspect the area to be welded (on both sides of material when possible) prior to welding, and relocate any objects that may be a fire hazard. When welding in a cab, make sure the interior surfaces are covered (e.g., welding blanket) and a fire extinguisher is at hand.
- Always use extreme caution when cutting and trimming during fitting.
- Always tighten all nuts and bolts securely per installation instructions.
- Always route electrical cables carefully. Avoid moving parts, components that become hot, and rough or sharp edges.
- Always insulate and protect all exposed wiring and electrical terminals.
- Perform regular inspections and maintenance on mounts and hardware.

TABLE OF CONTENTS

| | |
|----|--------------------------|
| 2 | SAFETY / DISCLAIMER |
| 3 | TABLE OF CONTENTS |
| 4 | A MESSAGE FROM THE OWNER |
| 5 | GETTING STARTED |
| 6 | PROVIDED MATERIAL |
| 8 | DISASSEMBLY |
| 16 | INSTALLATION |
| 19 | CONTACT |

A MESSAGE FROM THE OWNER



Fab Fours' was born out of a passion for customizing vehicles and a love for the outdoors. Our engineering team uses the latest 3D design software to turn new product ideas into reality. In our factory, designs come to life with the combination of cutting edge technology for metal cutting and forming and an American workforce that puts its' heart and pride into every product.

From design and manufacturing, to quality and delivery, Fab Fours' mission is to be the market leader for steel truck and jeep accessories. We make sure a quality product is delivered on time, more than expected, better than expected to our customers.

Enjoy your new Fab Fours product. Welcome to the family!

Ereg Higgs

FOUNDER, FAB FOURS

GETTING STARTED

Before you begin the installation process of your new Fab Fours product, we suggest laying out all materials and parts on a pad or protective surface.

Failure to fully account for all components before beginning installation may leave vehicle immobile until part is acquired. Refer to the next pages as an inventory check.

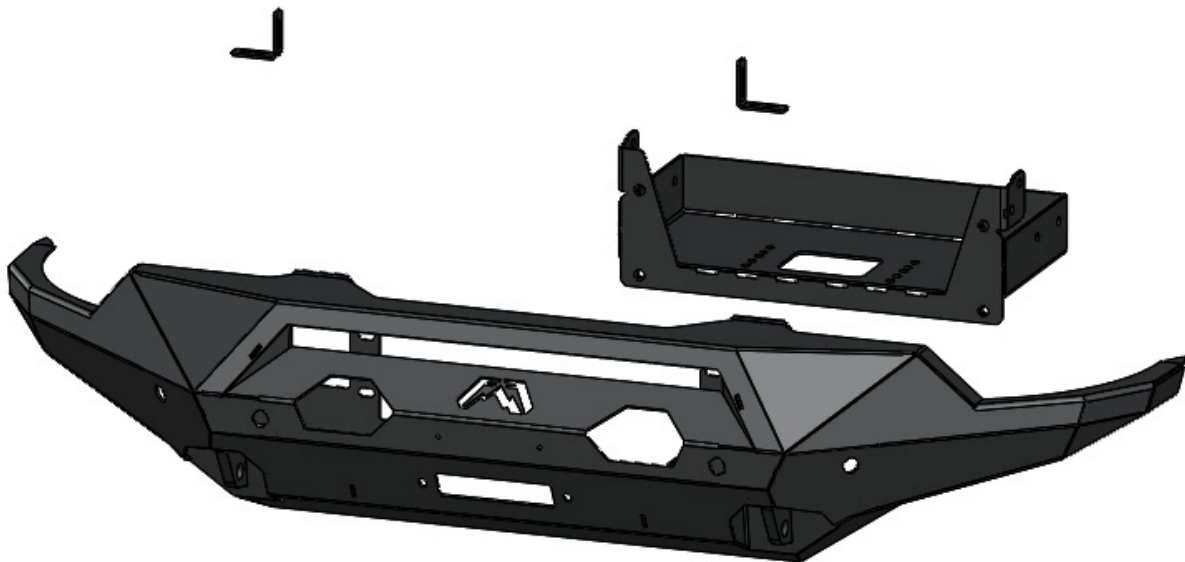

PROVIDED MATERIALS

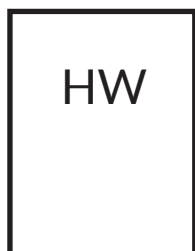

50178-HW

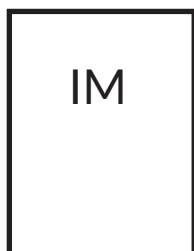

X395X-IM



61632
QTY: 2

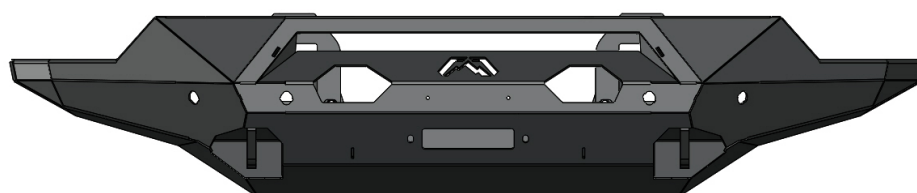

21871

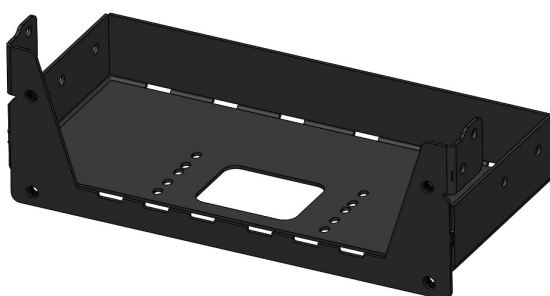

21872

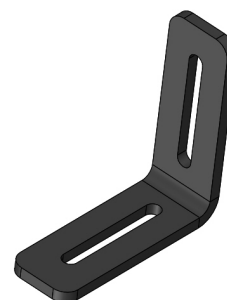

21871
QTY: 2

HARDWARE KIT | 50179

| FAB FOURS IDENTIFICATION | COMPONENT DESCRIPTION | QTY |
|--------------------------|--|-----|
| 50178-HW | 1/2"-13 x 1.25";Yellow-zinc, Grade 8, Hex head cap screw | 8 |
| 50178-HW | 1/2", SAE, Yellow-zinc, Grade 8, Lock washer | 12 |
| 50178-HW | 1/2", SAE, Yellow-zinc, Grade 8, Flat washer | 20 |
| 50178-HW | 1/2"-13, Yellow-zinc, Grade 8, Hex nut | 8 |
| 50178-HW | 1/2"-13 X 4", Yellow-zinc, Grade 8, Hex head cap screw | 4 |
| 50178-HW | 1/4"-20 x 1", Yellow-zinc, Grade 8, Hex head cap screw | 2 |
| 50178-HW | 1/4"-20, Yellow-zinc, Grade 8, Hex nut | 2 |
| 50178-HW | 1/4"-SAE, Yellow-zinc, Grade 8, Flat washer | 4 |
| 50178-HW | 1/4"-SAE, Yellow-zinc, Grade 8, Lock washer | 2 |

TOOLS REQUIRED

- Plastic panel pry tool
- Zip-ties
- 7/16" Open end wrench
- 3/4" Open end wrench
- 7/16" Socket wrench
- 3/4" Socket wrench
- 7mm Socket wrench
- 10mm Socket wrench
- 15mm Socket wrench
- T15 Torx bit
- 8" Long socket extension

ASSISTANCE

We recommend two people perform the installation as items are heavy and may need to be held in place while installing.

ORGANIZATION

Disassemble the vehicle where you can catalog and store everything. We suggest labeling and bagging all the OEM bolts when removing from the vehicle. Failure to keep track of parts could lead to an inability to properly reinstall components.

DISASSEMBLY

Note: Save all OEM parts until installation is complete!

1. Using a plastic panel pry tool, remove the ten (10) push pins along the grill cover and remove the grill cover from the vehicle. (Figure 1)



Figure 1

2. Using a 10mm socket wrench, remove the four (4) bolts attaching the grill to the truck. (Figure 2)

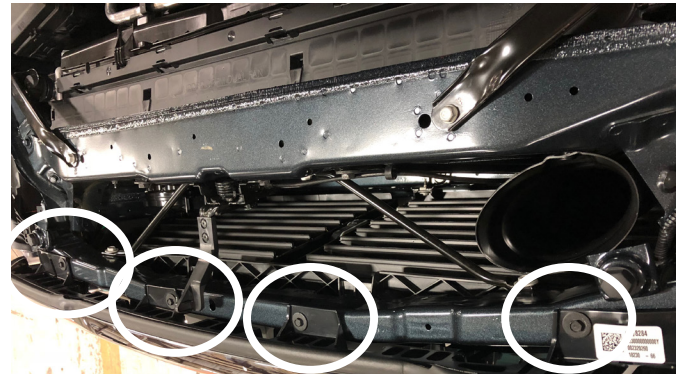

Figure 2

3. Using the T15 Torx bit, remove the two (2) screws attaching the inner fender liner to the valance on the driver side. (Figure 3) Then, using the T15 Trox bit remove the two (2) screws in the inner fender closest the bottom in front of the wheel. (Figure 4)



Figure 3



Figure 4

4. Using a plastic body panel pry tool, carefully pry outward on the plastic fender trim starting at the bottom front of the driver side and work upwards. Only remove as much of the fender trim as needed to get access to the one (1) screw attaching the valance to the fender. (Figure 5-6)



Figure 5



Figure 6

5. Using a 7mm socket wrench, remove the screw attaching the valance to the fender on the driver side. (Figure 7)



Figure 7

6. Using the plastic body panel pry tool, carefully remove the clips in the fender that were attaching the fender trim to the fender and reinstall them onto the backside of the fender trim on the driver side. (Figure 8)



Figure 8

7. Using a plastic body panel pry tool, depress the three (3) tabs under the headlight while pulling outward on the valance to release it from the driver side headlight. (Figure 9)



Figure 9

8. Repeat steps 3-7 on the passenger side.

9. Using the plastic body panel pry tool, release the five (5) clips behind the grille and remove the valance from the truck. (Figure 10)



Figure 10

10. Using a 10mm socket wrench remove the three (3) bolts holding the lower portion of the grille to the vehicle. (Figure 11)



Figure 11

11. Using the plastic body panel pry tool, remove the eight (8) ribbed shank push pins holding the air dam along the front of the louver system to remove the air dam. (Figure 12)

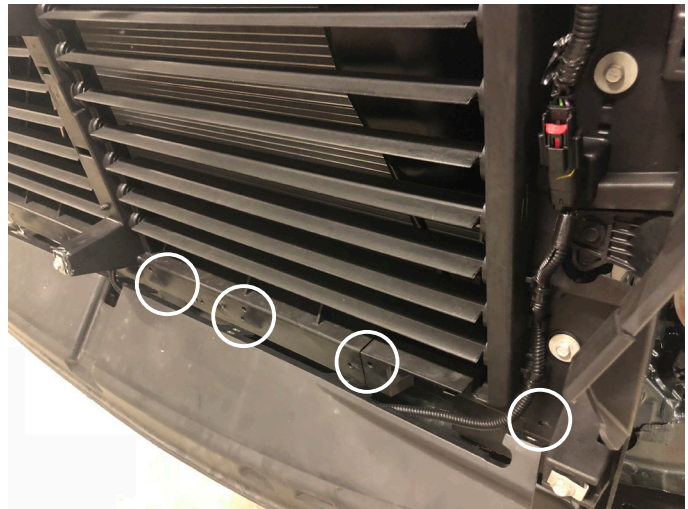

Figure 12

12. Using an 18mm socket wrench, remove the two (2) bumper mounting bolts on the top of the bumper. (Figure 13)



Figure 13

13. Using an 18mm socket wrench with 8" long extension, remove the two (2) 18mm bolts holding the bumper to the frame inboard of the two (2) bolts removed in step 12. (Figure 14)



Figure 14

14. Using an 18mm socket wrench, remove the two (2) bolts attaching the bumper reinforcement brackets to the bumper on the driver side. (Figure 15)



Figure 15

15. Repeat step 14 on the passenger side.

16. Unplug the sensor harness located on the passenger side of the vehicle. (Figure 16)



Figure 16

17. Remove the OEM electrical harness from bumper using a plastic body panel pry tool to remove the ribbed shank push pins. (Figure 17)

Note: Document the location of each sensor housing for reference when reinstalling into your bumper.



Figure 17

18. Disconnect the electrical harness from the fog lights in the bumper by depressing the tab and pulling away from the light. (Figure 18)



Figure 18

19. Remove the sensor from the sensor housing by expanding both sides of the sensor housing and lift up. (Figure 19-20)

Note: Sensors are extremely delicate and must be handled with care! Do not push on face of sensors to remove!

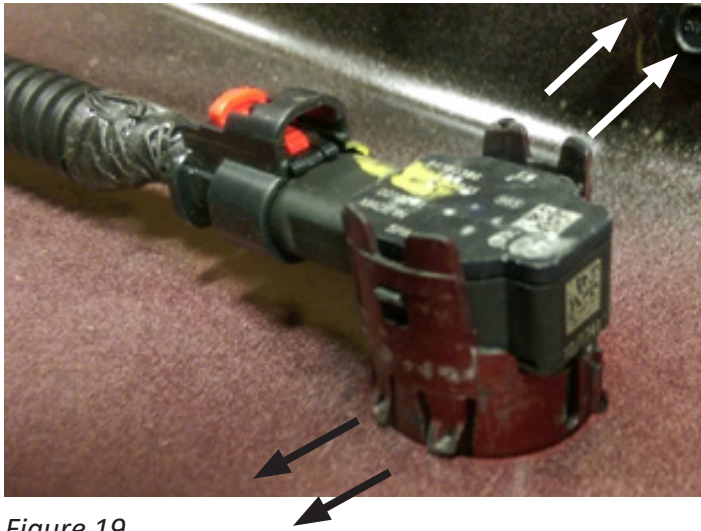

Figure 19

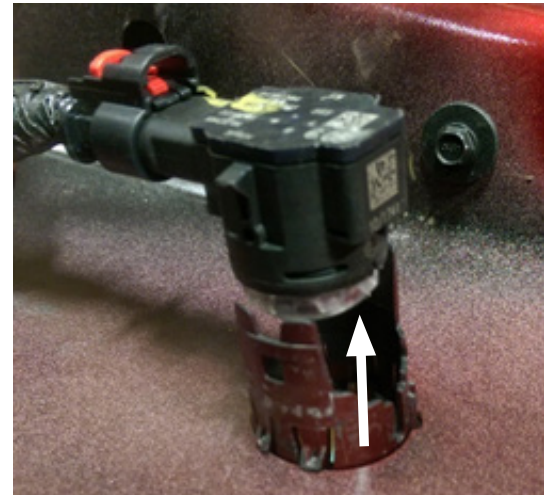

Figure 20

20. Remove the sensor housing from the bumper by depressing the four (4) tabs while pulling outward from the outside of the bumper. (Figure 21-22)



Figure 21

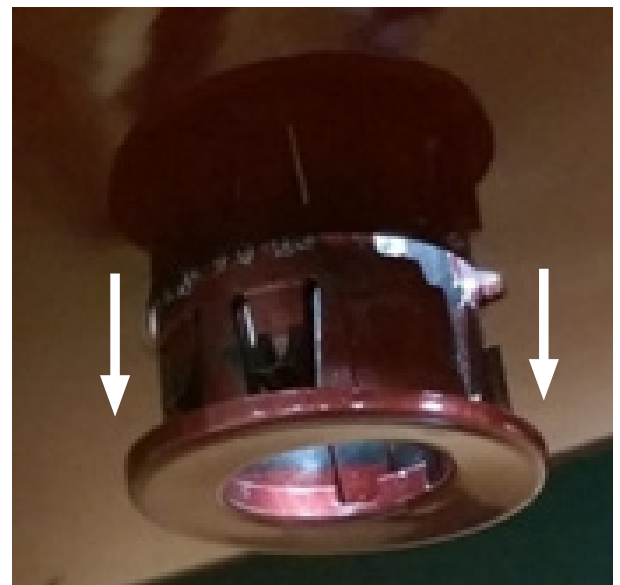

Figure 22

21. Using a 15mm socket, remove the six (6) bolts from the frame horns and remove from the truck. (Figure 23)



Figure 23

22. If vehicle is equipped with OEM tow hooks, remove them using an 18mm socket and 18mm open end wrench to remove the two (2) bolts per frame rail. (Figure 24)



Figure 24

INSTALLATION

NOTE: If not running a lightbar skip the next step.

23. Reinstall the sensor harness (if applicable) into the new Matrix bumper in the same orientation it was removed from the factory bumper. (Figure 25) Use the brackets below the winch access holes to attach the harness to the bumper with zip ties or similar. (Figure 26)

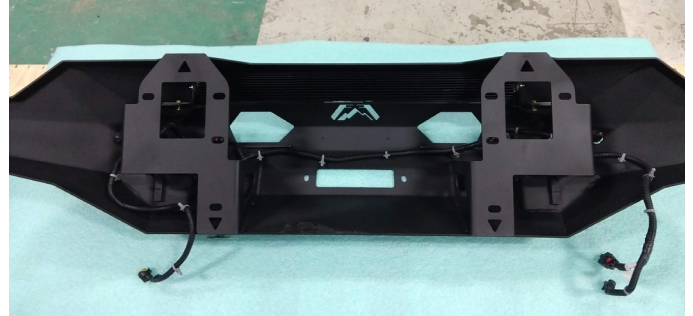

Figure 25



Figure 26

24. Reinstall the sensor housing into the Matrix bumper in the same location and orientation that they were removed from the factory bumper. Reinstall the sensors into their respective housings by reversing the process used to remove them from the factory bumper. (Figure 27)



Figure 27

25. Using a 7/16" open end wrench and 7/16" socket wrench, install the provided two (2) light bar brackets (21871-10) with the provided 1/4" yellow-zinc, grade 8, bolts, flat washers, lock washers, and nuts (50178-HW). (Figure 28-29) Then, install the lightbar to the provided brackets per the lighting manufactures instructions.

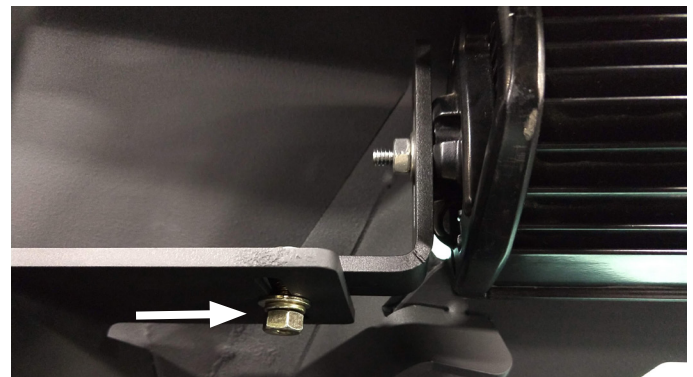

Figure 28

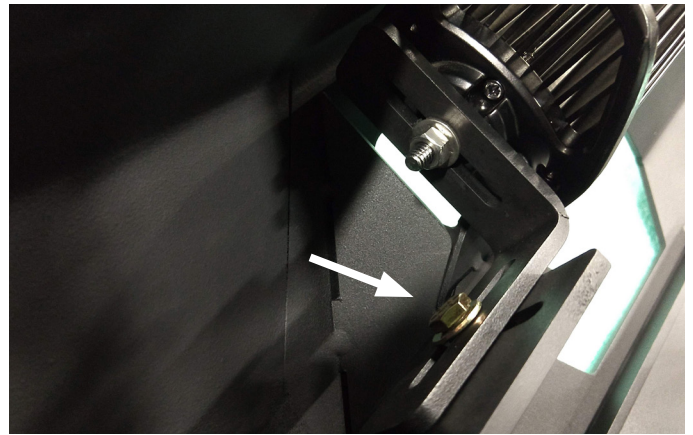

Figure 29

26. Using a 3/4" open end wrench and 3/4" socket wrench, loosely install the provided winch tray (21872) to the underrun guards on the bottom of the frame rails with four (4) of the provided 1/2"x 4" yellow-zinc, grade 8, bolts, flat washers, lock washers, and nuts (50178-HW). (Figure 30)



Figure 30

27. Using a 3/4" open end wrench and 3/4" socket wrench, finish loosely installing the provided winch tray (21872) to the inside of the frame rails with four (4) of the provided 1/2"x 1.25" yellow-zinc, grade 8, bolts, flat washers, lock washers, and nuts (50178-HW). (Figure 31)

NOTE: If using a winch, install it in the winch tray at this point per the winch manufactures instructions.

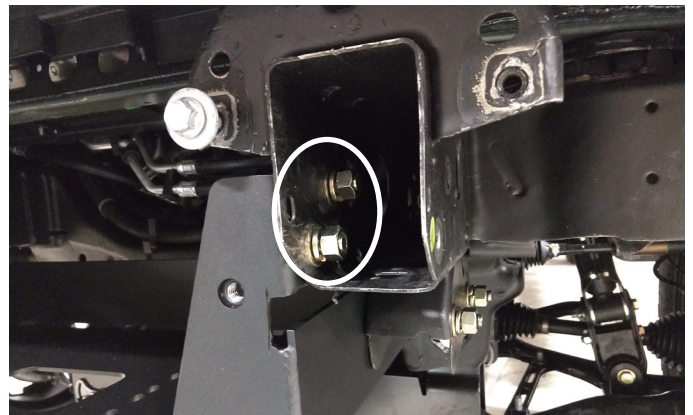

Figure 31

28. Using a 15mm socket wrench, loosely install the bumper on the vehicle (21871) to the frame horns with four (4) factory bolts removed in step 21 of disassembly. (Figure 32-33)



Figure 32

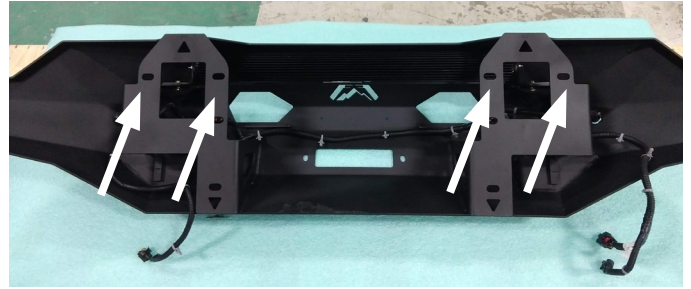

Figure 33

29. Using a 3/4" socket wrench, finish loosely installing the bumper (21872) to the winch tray (21872) with four (4) of the provided 1/2"x 1.25" yellow-zinc, grade 8, bolts, flat washers, and lock washers (50178-HW). (Figure 34-35)



Figure 34

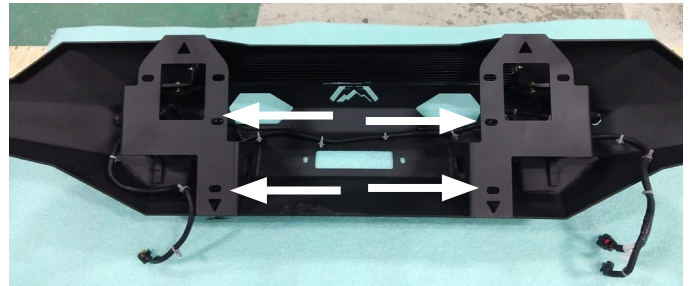

Figure 35

NOTE: If using a winch, install the fairlead now per the manufactures instructions and their hardware.

30. Test the functionality of the sensors. If they are functioning correctly apply the provided epoxy (61632) around the sensor housings on the inside face of the bumper.

31. Adjust the fitment and alignment of the bumper to the vehicle and then tighten all hardware.

CONTACT INFORMATION

**FAB FOURS INC.
2213 INDUSTRIAL PARK ROAD
LANCASTER, SC 29720**

PHONE: (866) 385-1905

FAX: 866-574-1423

EMAIL: SUPPORT@FABFOURS.COM

WWW.FABFOURS.COM



**“IF YOU’RE LOOKING FOR MORE OF THE SAME,
THEN YOU’VE COME TO THE WRONG PLACE.”**

- GREG HIGGS

