



INSTALLATION MANUAL

VICOWL

PRODUCT NUMBER: VC4200

APPLICATION: 2019 DODGE RAM 1500



IMPORTANT SAFETY GUIDE | Your safety and the safety of others is very important.

In order to help you make informed decisions about safety, we have provided the following warnings, safety precautions, installation instructions, and other important information to alert you to potential hazards that could hurt you or others.

Please do a job safety analysis before each task to identify potential hazards for your situation and remove/protect against them. Use own good judgment and take your time.

Check packaged materials immediately upon arrival to ensure that all listed parts are included and undamaged.

Read and understand all warnings, safety precautions, and instructions before installing this product.

SENSORS FIELD OF VIEW MAY BE ALTERED WITH USE OF THE REPLACEMENT BUMPER.

WARNINGS

- Failure to observe the following warnings and instructions provided in this manual could lead to severe injury and/or death.
- For professional installation only. Careless installation and/or operation can result in serious injury, death, and/or equipment damage. All liability for installation and use rests with the user or consumer.
- Fab Fours, Inc. only approves installing this product according to these written instructions with the hardware provided. Failure to install according to these instructions will invalidate the warranty. This includes, but is not limited to, using alternative installation methods, hardware, or materials.
- This product is for off road use only.

SAFETY PRECAUTIONS

- Always remove jewelry and wear eye protection.
- Always use extreme caution when jacking up a vehicle for work. Set emergency brake and use tire blocks. Locate and use the vehicle manufacturers designated lifting points. Use jack stands.
- Always use appropriate and adequate care in lifting components into place.
- Always ensure components will remain secure during installation and operation.
- Always wear safety glasses when installing this kit. A drilling operation will cause flying metal chips. Flying chips can cause serious eye injury.
- Always use extreme caution when drilling a vehicle. Always disconnect power before welding. Thoroughly inspect the area to be drilled (on both sides of material when possible) prior to drilling, and relocate any objects that may be damaged.
- Always use extreme caution when welding a vehicle. Thoroughly inspect the area to be welded (on both sides of material when possible) prior to welding, and relocate any objects that may be a fire hazard. When welding in a cab, make sure the interior surfaces are covered (e.g., welding blanket) and a fire extinguisher is at hand.
- Always use extreme caution when cutting and trimming during fitting.
- Always tighten all nuts and bolts securely per installation instructions.
- Always route electrical cables carefully. Avoid moving parts, components that become hot, and rough or sharp edges.
- Always insulate and protect all exposed wiring and electrical terminals.
- Perform regular inspections and maintenance on mounts and hardware.

TABLE OF CONTENTS

- 2 SAFETY / DISCLAIMER
- 3 TABLE OF CONTENTS
- 4 A MESSAGE FROM THE OWNER
- 5 GETTING STARTED
- 6 PROVIDED MATERIAL
- 8 DISASSEMBLY
- 12 INSTALLATION
- 23 CONTACT

A MESSAGE FROM THE OWNER



Fab Fours' was born out of a passion for customizing vehicles and a love of the outdoors. Our engineering team uses the latest 3D design software to turn new product ideas into reality. In our factory, designs come to life with the combination of cutting edge technology for metal cutting and forming and an American workforce that puts its' heart and pride into every product.

From design and manufacturing, to quality and delivery, Fab Fours' mission is to be the market leader for steel truck and jeep accessories. We make sure a quality product is delivered on time, more than expected, better than expected to our customers.

Enjoy your new Fab Fours product. Welcome to the family!

Ereg Higgs

FOUNDER, FAB FOURS

GETTING STARTED

Before you begin the installation process of your new Fab Fours product, we suggest laying out all materials and parts on a pad or protective surface.

Failure to fully account for all components before beginning installation may leave vehicle immobile until part is acquired. Refer to the next pages as an inventory check.



PROVIDED MATERIALS

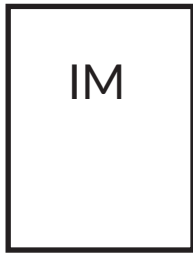

VC4200-IM



50172-HW



61720
QTY: 2

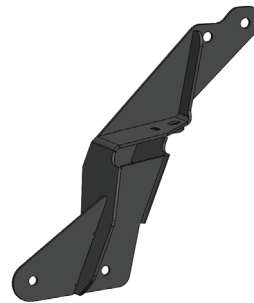

21836



21837

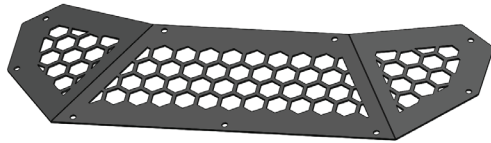

21313

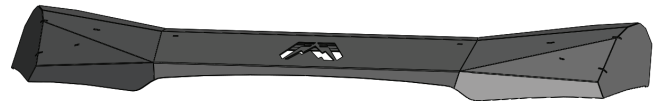

21832



61724

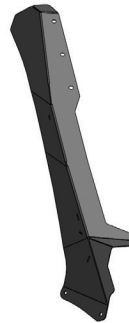

21830

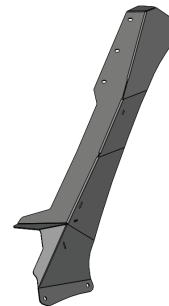

21830

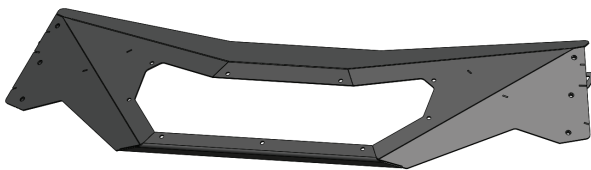

21833

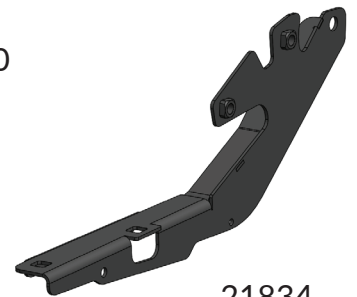

21834

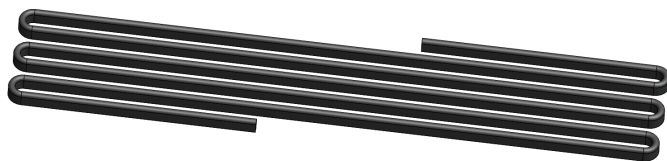

61723

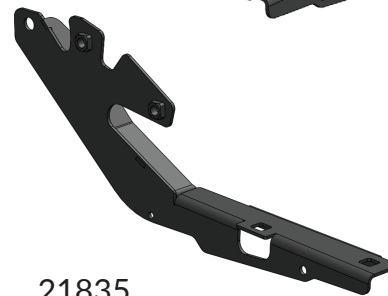

21835

HARDWARE KIT | 50172

FAB FOURS IDENTIFICATION	COMPONENT DESCRIPTION	QTY
50172- HW	Oil-embedded thrust bearing	2
50172- HW	Oil-embedded flanged sleeve bearing	2
50172- HW	Threadlocker, blue loctite® 242, 0.02 oz. capsule	1
50172- HW	3/8"-16 x 1 1/4 ", yellow zinc, hex cap screw, grade 8	8
50172- HW	5/16"-18, Nylock hex nut	9
50172- HW	5/16", stainless steel, flat washer	9
50172- HW	5/16"-18 x 3/4", stainless steel, button head cap screw	9
50172- HW	5/16", rubber bonded sealing washer	9
50172- HW	1/2", yellow zinc, flat washer, grade 8	2
50172- HW	17/32" drill bit with a 1/2" shank	1
50172- HW	3/8"- expandable Inset Tool	1
50172- HW	3/8"-16 X 3/4" stainless steel, button head cap screw	10
50172- HW	3/8", rubber bonded sealing washer	10
50172- HW	3/8"-16, knurled Rivet Nut	4
50172- HW	8mm, stainless steel, ball stud, M8 X 1.25 threads	2
50172- HW	3/8", yellow zinc, flat washer, grade 8	10
50172- HW	3/8", yellow zinc, lock washer, grade 8	6
50172- HW	3/8"-16, yellow zinc, Nyloc nut, grade 8	2
50172- HW	5/16"-18 x 1", yellow zinc, hex cap screw, grade 8	2
50172- HW	5/16", yellow zinc, flat washer, grade 8	2
50172- HW	5/16", yellow zinc, lock washer, grade 8	2
50172-HW	M8 x 1.25, Nyloc nut, stainless steel	2

TOOLS REQUIRED

- 3/16" Allen Wrench
- 7/32" Allen Wrench
- 9/16" open end wrench
- 10mm open end wrench
- 9" long socket extension
- Pair of 9/16" socket wrenches
- 1/2" socket wrench
- 8mm socket wrench
- 13mm socket wrench
- 15mm socket wrench
- Socket swivel
- Scissors
- Transfer punch
- 1/8" drill bit
- 1/4" drill bit
- 3/8" drill bit
- Blue painters tape
- Pen or Pencil
- Sharpie
- Knife
- Pick or small flat head screwdriver
- Plastic panel pry bar
- 6" Ruler
- Tap or wire brush

ASSISTANCE

We recommend two people perform the installation as items are heavy and may need to be held in place while installing.

ORGANIZATION

Disassemble the vehicle where you can catalog and store everything. We suggest labeling and bagging all the OEM bolts when removing from the vehicle. Failure to keep track of parts could lead to an inability to properly reinstall components.

DISASSEMBLY

1. Apply a small amount of blue painter's tape across the hood and fender on both driver and passenger side. Mark the tape with a straight-line perpendicular with the hood and fender body seam. Use a knife to cut the tape along the hood and fender seam. (Figure 1)



Figure 1

2. Using a 13mm socket wrench, loosen the four (4) nuts that secure the hood to the upper hood hinge bracket so they can be removed by hand. (Figure 2, #1)

3. Disconnect any electrical connections and washer fluid lines if your vehicle is equipped.

4. With assistance and with a 13mm socket wrench, remove the four (4) hood bolts and remove the hood.

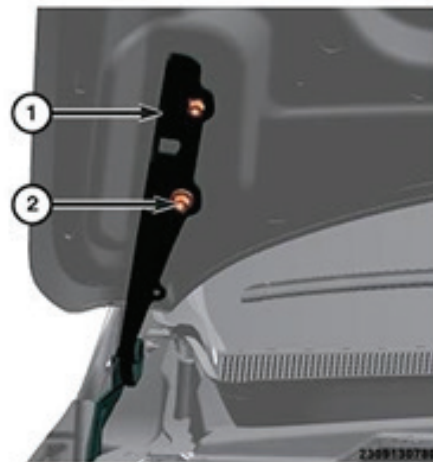

Figure 2

5. Using a plastic panel pry tool and your hands, pull the OEM wiper cowl trim panel up and away from the windshield. Perform this on both driver side and passenger side cowl trim. These panels are retained by three (3) steel spring clips. (Figure 3)



Figure 3

6. Using a plastic panel pry tool, pop the two (2) wiper nut covers off the nut heads.

7. Using a 15mm socket wrench, remove the two (2) wiper nuts and remove the two (2) wipers.

NOTE: Be mindful that the passenger side and driver side wiper arms are different lengths and should be marked or tagged appropriately for reinstallation.

8. Using a plastic panel pry tool, remove the eight (8) panel push pins to remove the OEM wiper cowl. (Figure 4)

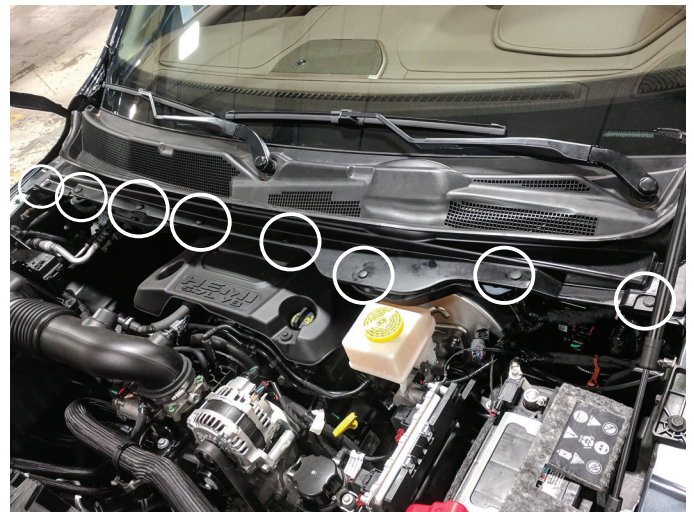

Figure 4

9. Using an 8mm socket wrench, remove the two (2) screws holding the splash shield trim to the wheel well. (Figure 5, #1)

10. Using a plastic panel pry tool, remove the single push pin from the splash shield trim. (Figure 5, #2)

11. Remove the splash shield trim from the fender.

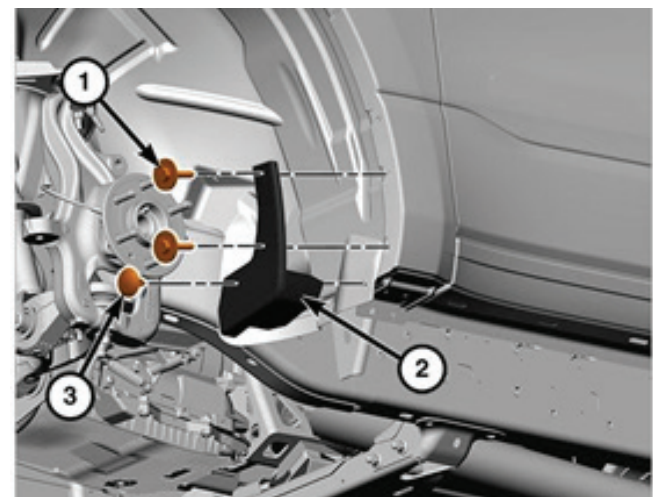

Figure 5

12. Using an 8mm socket wrench, remove the eight (8) or ten (10) wheel well liner bolts. (Figure 6, #2)

13. Using a plastic panel pry tool, remove the push pin retainer from the wheel well liner. (Figure 6, #1)

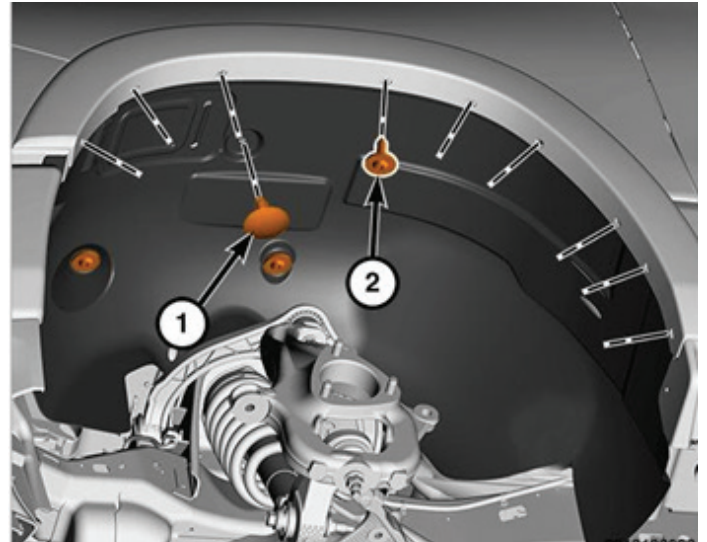

Figure 6

14. Using a plastic panel pry tool, remove the one (1) push pin from the inside front of the wheel well liner. (Figure 7,#1)

15. Using an 8mm socket wrench, remove the two (2) bolts from the wheel well liner. (Figure 7,#2)

16. Remove the wheel well liner on both sides of the vehicle.

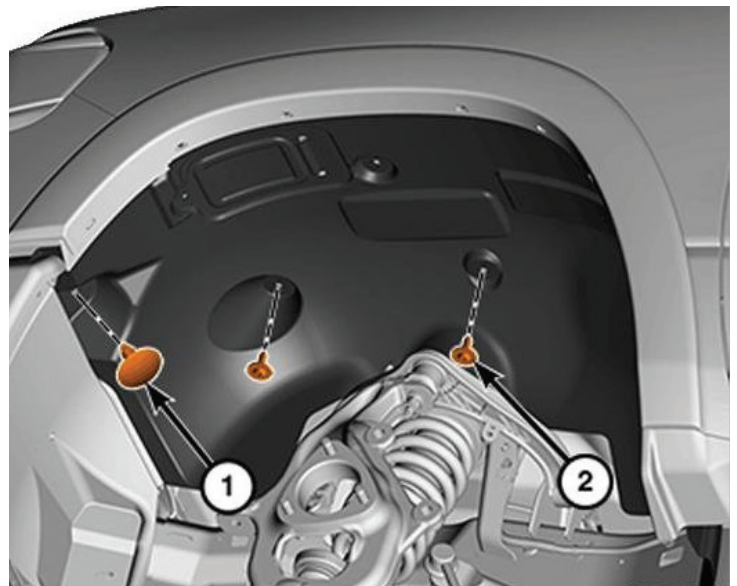

Figure 7

17. Using a small pick or screwdriver, pry out on the metal spring clip (Figure 8, #2). Pull the air spring head (Figure 8, #1) away from the ball stud (Figure 8, #4) while the spring clip is pulled away. Disconnect the air spring from the bracket only and leave attached to frame rail. Rotate forward out of the way.

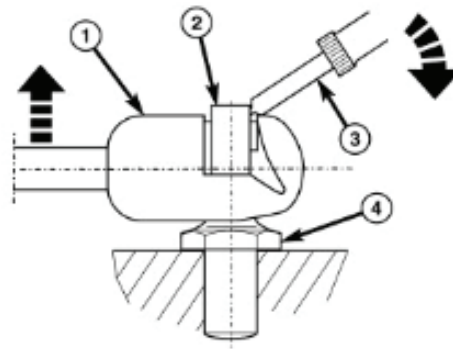

Figure 8

18. Using a 13mm socket wrench, remove the two (2) lower hood hinge bolts. (Figure 9, #2)

19. Remove the hood hinges from the fender.

NOTE: The OEM hood hinges will not be reinstalled.

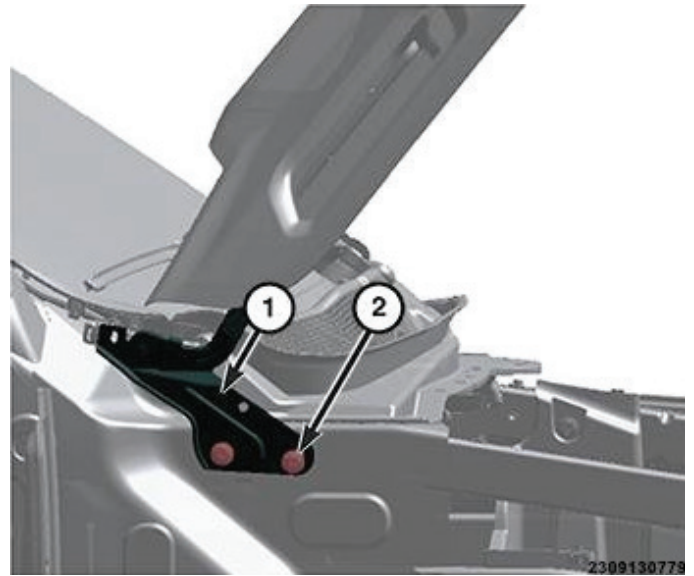

Figure 9

INSTALLATION

NOTE: Both driver side and passenger side brackets install the same way procedurally, but opposite as driver side and passenger side.

1. Install the brass bushing into the upper hole in the upper bracket (21835)(50172-HW). (Figure 10)

2. Stack the 3/8"-16 yellow zinc hex head bolt and the yellow zinc flat washer and place over the brass bushing. Add the brass thrust washer, followed by the lower bracket (21837), yellow zinc flat washer and 3/8"-16 yellow zinc Nyloc nut. Using a pair of 9/16" socket wrenches, tighten the Nylock nut making sure the thrust washer does not pop out of the brass bushing. (50172-HW) (Figure 10)

3. Using a pair of 9/16" socket wrenches, fully assemble and tighten the passenger side opposite of what is shown in Figure 10

4. Insert the passenger side bracket where the OEM bracket was removed.

5. Finger tighten the two (2) factory bracket bolts (Figure 11)

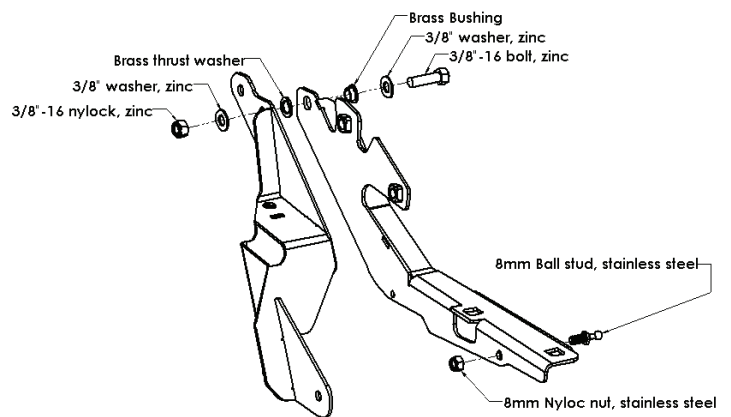

Figure 10



Figure 11

6. Pull up on the lower hinge bracket rotating the assembly away from the windshield. Using a 13mm socket wrench, fully tighten the two (2) factory bracket bolts.

7. Using a 1/2" socket wrench, use the provided 5/16"-18 yellow zinc hex head bolt, yellow zinc lock washer, and yellow zinc flat washer, to tighten the upper fender bolt location to the bracket (21837). (50172-HW) (Figure 12)



Figure 12

8. Using a 10mm open end wrench and 13mm socket wrench, install the ball joint, flat washer and M8 Nylock nut from the provided hardware kit, snap the OEM air spring to the ball stud on the upper bracket. (50172-HW) (Figure 13)

9. Repeat the same steps for the driver side bracket.

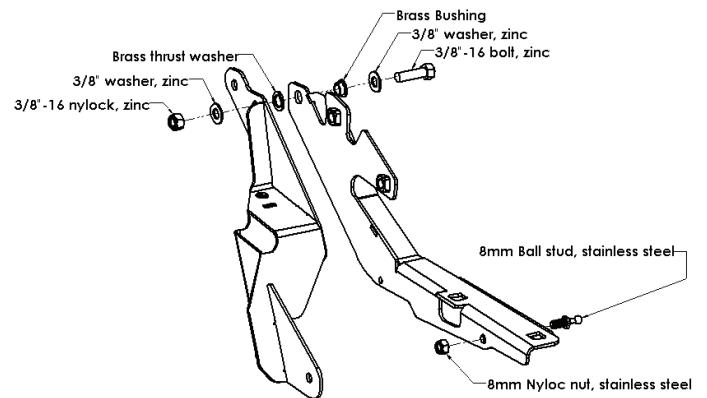

Figure 13

10. Apply blue painters tape to both sides of the top of the hood to protect the paint from any damage caused by reinstalling the hood to the brackets. (Figure 14)

11. With assistance, lift the hood onto the upper bracket of the hood brackets and hand tighten the four factory nuts.

12. Align the upper bracket with the missing paint marks made under the hood from the factory brackets.

13. Lower the hood slowly and check for uniform hood gap and alignment of lines on blue tape made during the disassembly of the OEM hinges. Adjust as needed. (Figure 15)

14. Slowly raise the hood just enough to reach in with a 13mm socket wrench and fully tighten down the four (4) factory bolts securing the hood.

15. Fully raise hood and reconnect the wiper fluid line and the push pin clip into the elbow of the hinge upper arm. (Figure 16)

NOTE: Be mindful of how high you raise the hood while making adjustments to alignment. It is possible that the hood will shift without your knowledge if hood is raised too high.



Figure 14



Figure 15



Figure 16

16. Remove all painters tape from the vehicle.

17. Using a sharpie or other marking device, mark the OEM wiper cowl with cutting lines. Mimic the lines shown in the images provided. (Figure 17-18)

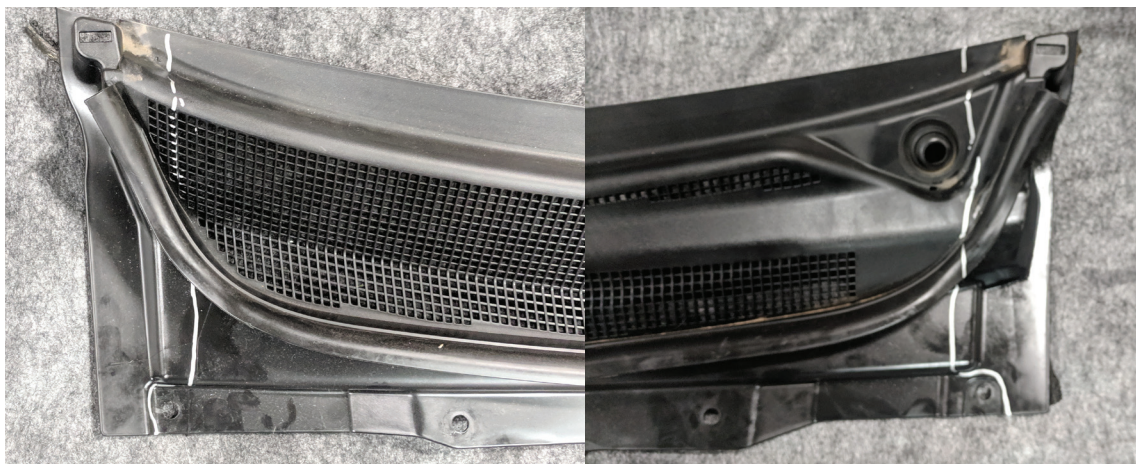

Figure 17

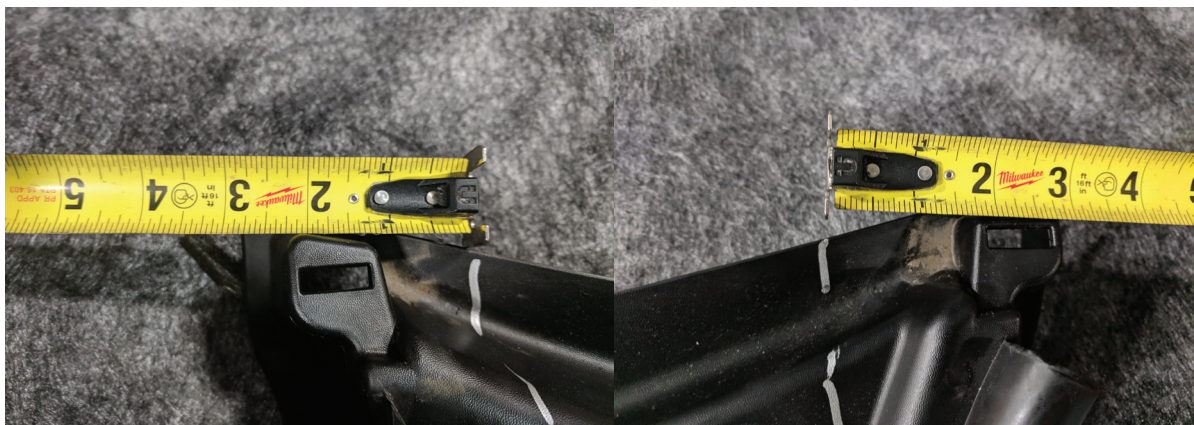

Figure 18

18. Using a cutting tool, trim the OEM cowl along the marked lines. (Figure 19)

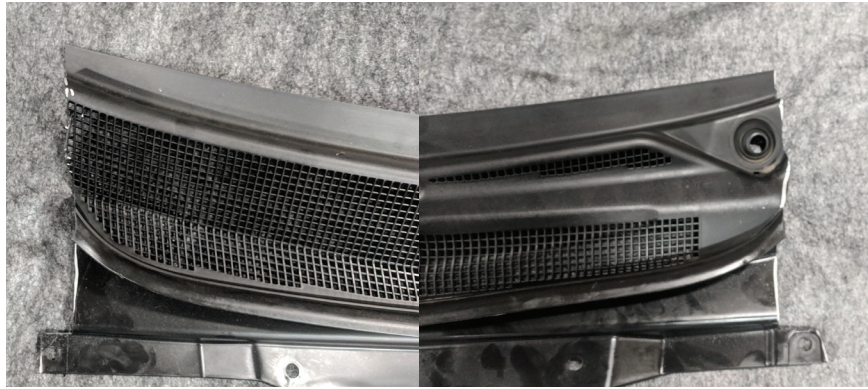

Figure 19

19. Reinstall the OEM cowl, and wiper arms in the reverse method of removal.

14. With assistance, hold the bumper up to the frame rail end while inserted on the frame rail end pin.

NOTE: It's highly recommended that all weld nuts are chased with the appropriate taps to clean out any powder coat or foreign debris prior to assembly. Tap sizes needed to do this are 1/2"-13, 3/8"-16, and 5/16"-18.

NOTE The rubber bonded washer is used on the outside surface of the visor to reduce any powder coat wear marks that would be created using normal flat washers and visible if bolts are moved due to reassembly of visor with light insert.

20. Install and hand tighten the two (2) rubber bumpers (61720) and two (2) 1/2" yellow zinc flat washers to the visor. (50172-HW) (Figure 20)

21. Using a 3/16" allen wrench and 1/2" socket wrench, install and tighten the visor trim (21313) (or light insert if purchased) into the back of the visor (21833) using the nine (9) 5/16"-18 stainless steel bolts, rubber bonded stainless steel washer, stainless steel flat washer, and 5/16"-18 stainless steel Nylock nut provided in the hardware kit. (50172-HW) The bolt stack starts from the outside and finishes with the nut on the inside. (Figure 21)

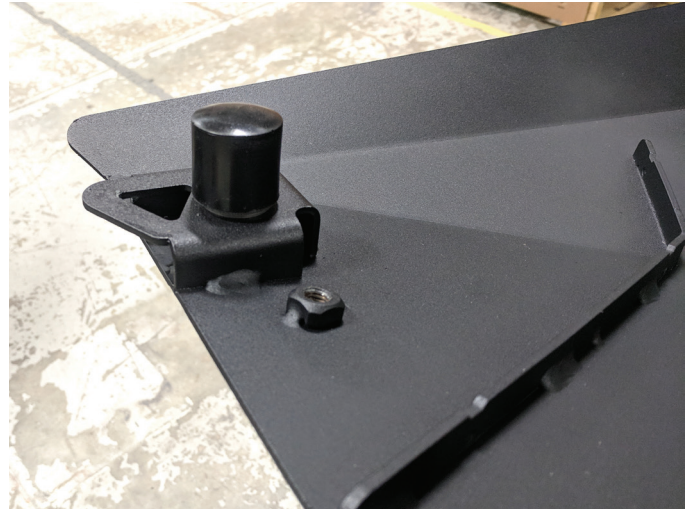

Figure 20



Figure 21

NOTE: bolt stacks with a rubber bonded washer will never feel fully tight. Tighten the bolt just enough before the rubber squeezes out.

22. Using the provided 1" wide neoprene rubber strip (61724), cut and install the one (1) strip to the inside of both arms (21830,21831) at 6" long. (Figure 22)

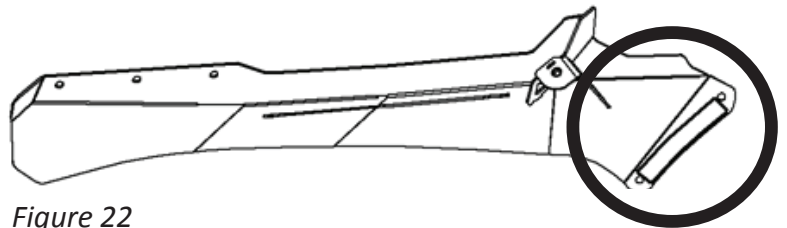

Figure 22

NOTE: leave about a 1/8" reveal on the edge of the arms. This will ensure the rubber strip doesn't shift or show after installation. There will be extra material

23. Hand tighten both ViCowl arms (21830, 21831) to the visor (21833) using the six (6) 3/8"-16 yellow zinc, hex cap screws and rubber bonded washers provided in the hardware kit. (50172-HW) (Figure 23)

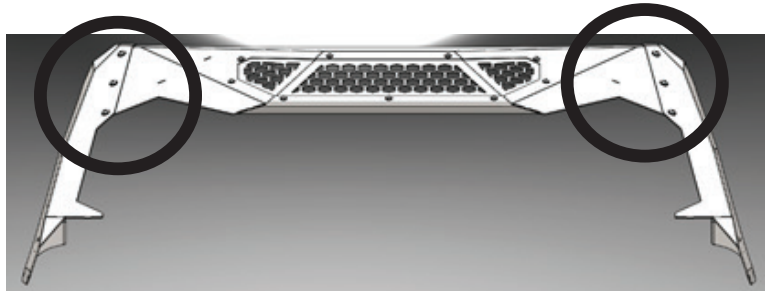

Figure 23

24. Install the provided edge trim with adhesive (61723) onto the leading edge of the Cowl (21832). (Figure 24)

NOTE: Do not stretch the seal as you apply it to the Cowl. Doing so may cause the seal to pull away from the sheet metal in the future.



Figure 24

25. The edge seal should terminate at the hook of the Cowl on each end. (Figure 25)



Figure 25

26. Using a pair of scissors, trim the edge seal for fit and finish.

27. With assistance, lift the upper ViCowl assembly up over the hood and slowly lower the arms into position. The arm mounting bracket should rest to the outside of the lower hinge and lined up with the rear bolt hole.

28. Hand tighten the provided 3/8"-16 yellow zinc, hex head bolt, yellow zinc lock washer and yellow zinc flat washer through the lower hinge bracket and into the arm securing the ViCowl from falling lower on the vehicle. (50172-HW) (Figure 26)

29. Check for fit. Using a 9/16" socket wrench, 9" extension, and swivel, fully tighten down both arms to the hinge brackets.

30. Using a transfer punch, mark the Rivnut hole location on both driver and passenger fenders before removing the ViCowl for drilling. (Figure 27)

NOTE: A high degree of accuracy is needed when marking the Rivnut locations. Hold the arm tight to fender if needed while marking. The Rivnuts constitute a majority percentage of the mounting strength of the upper ViCowl to the vehicle. A hole center punch is recommended followed by incremental pilot holes to the finish hole size of the included 17/32" drill bit. You will have trouble lining up bolt holes if Rivnuts are misplaced.



Figure 26



Figure 27

31. Remove the upper ViCowl assembly in preparation to drill and install the four Rivnuts in the fenders.

32. Using the 1/8" drill bit, drill out a pilot hole in each of the four (4) marked locations

33. Using the 3/8" drill bit, step up the four (4) pilot holes. Drill directly perpendicular to the side of the fender.

34. Using the provided 17/32" drill bit, drill out the four (4) holes. (50172-HW)

35. With the expendable tool threaded into the Rivnut, insert it into one of the holes making sure that it fits in far enough to flush the collar of the Rivnut to fender panel. For an exceptional installation coat the knurls of the Rivnut with the provided Loctite. (50172-HW)

36. Place the 9/16" open end wrench on the body of the expendable tool and the 9/16" socket wrench on the bolt head on the back side of the tool. (Figure 28)



Figure 28

37. Tighten the bolt into the Rivnut until it becomes snug in the fender panel. **DO NOT OVERTIGHTEN CAUSING THE INSERT TO SPIN!**

38. Repeat steps 6-10 to drill the remaining Rivnut hole locations marked on the vehicle.

39. With assistance, reinstall the upper ViCowl using steps 1-3 of the ViCowl installation section.

40. Using a 7/32" allen wrench, install the provided 3/8"-16 stainless steel button head bolts, rubber bonded stainless steel washers using provided Loctite. (50172-HW) (Figure 29)

41. Using an extension and 9/16" socket wrench, fully tighten the provided 3/8"-16 yellow zinc hex head bolt used to tighten the arm to bracket. (50172-HW)

42. Check for symmetry of the visor and both arms. Using a 7/32" allen wrench, fully tighten the provided six (6) 3/8" stainless steel button head screws with rubber bonded stainless steel washers. (50172-HW)

43. With assistance, lower the Cowl up on the mounting surface of the arms. The Cowl mounting surface goes to the outside of the bracket mounting surface.

44. Hand tighten the four (4) provided 3/8"-16 yellow zinc hex head bolts, yellow zinc lock washers and yellow zinc flat washers into the Cowl on both passenger and driver side. (50172-HW) (Figure 30)



Figure 29

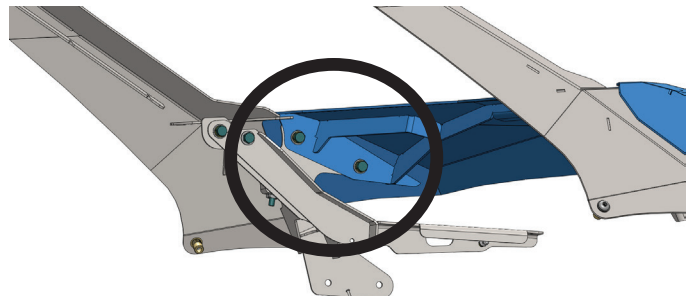

Figure 30

45. Using a plastic panel pry bar, insert the prybar under the Cowl and on top of the arm to maintain a symmetrical gap on each arm. (Figure 31)

NOTE: An 1/8" gap is required on both sides to prevent rubbing the Cowl and the arm together and causing damage.

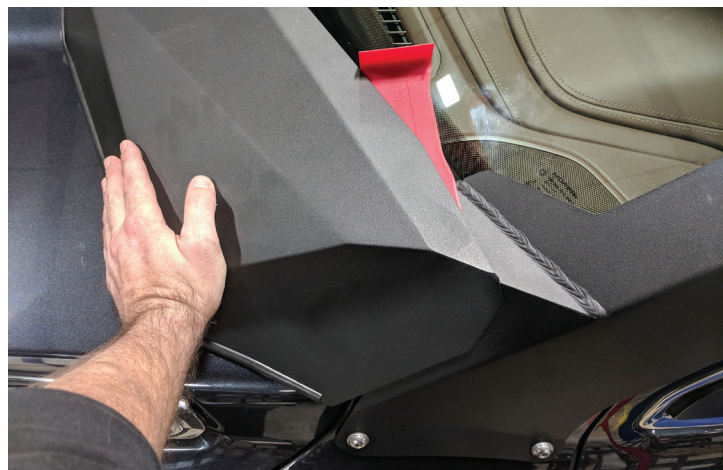

Figure 31

46. Push down the front of the Cowl closing any gap that may be between the hood and the edge trim of the Cowl. Fully tighten down the front bolt and then the back bolt.

NOTE: We recommend using an impact driver, long extension, and swivel to make tighten down of the Cowl hardware.

47. Remove the plastic panel pry bar.

48. Repeat steps 45-46 for the opposite side of the vehicle.

49. Once the ViCowl is fully installed, reinstall the well liners and splash guard.

CONTACT INFORMATION

**FAB FOURS INC.
2213 INDUSTRIAL PARK ROAD
LANCASTER, SC 29720**

PHONE: (866) 385-1905

FAX: 970-385-1914

EMAIL: SUPPORT@FABFOURS.COM

FABFOURS.COM



**“IF YOU’RE LOOKING FOR MORE OF THE SAME,
THEN YOU’VE COME TO THE WRONG PLACE.”**

- GREG HIGGS

