

## Cognito 8-Inch Component Box 2017-2022 Ford F250/F350 4WD Super Duty Trucks

**INSTALL INSTRUCTIONS:**

**Cognito 8-Inch Component Box 2017-2022 Ford F250/F350 4WD  
 Super Duty Trucks  
 SKU: 120-70094**

**PARTS LIST FOR SKU: 120-70094**

QUANTITY	PART #	DESCRIPTION
1	8313	2011+ FSD 4" Sway Bar Drop Bracket Driver
1	8544	2017+ Ford F250 F350 4WD Steering Stabilizer Frame Bracket
1	8547	2011+ Ford F250 F350 4WD Front Track Bar Bracket
1	8548	2017+ FSD Steering Stabilizer Adaptor Mount
2	8562	2017+ FSD 4-1/2" Bumpstop Spacer
1	8577	2017+ FSD Carrier Bearing Drop Bracket
1	8582	2011+ FSD 4" Sway Bar Drop Bracket Passenger
2	8817	2017+ Ford 5" Extended Rear Sway Bar End Link
1	120-70095	2017+ Ford F250 / F350 4WD Super Duty trucks Stainless Steel Front Brake line kit for 8"-9" lifted
1	120-90699	2017+ Front Sway Bar End Link Kit for 4" lifts on Ford F250 / F350 4WD Super Duty and 2017-2019 3.5" lifts on Ford F450 4WD Super Duty trucks
1	PITMAN-ARM-FORD-1	2005+ Ford F250 And F350 4" Dropped Pitman Arm
1	BRAKELINE-1032	FSD Rear Brakeline for 6+" Lifts
1	HP9218	2017+ FSD E-Brake Cable Relocation Kit
1	HP9219	2017+ Ford Sway Bar Hardware
1	HP9245	2017+ Ford Steering Stabilizer hardware
1	HP9276	2017+ Ford 4.5" Bump Stop Hardware for F250-350
1	HP9051	Rear Sway Bar End Link Hardware

**WARNING**

Please read this entire instruction sheet before beginning installation. Proper installation of these components requires a qualified mechanic. Always wear safety glasses when using power tools, and take appropriate precautions when working under a vehicle. If these instructions are not properly followed you may jeopardize your, and your passenger's safety, and severe frame, suspension or tire damage may also result from improper installation.

**PARTS LIST FOR SKU: HP9218**

QTY	PART #	DESCRIPTION
1	2524	FSD Brake Cable Bracket
2	HARDWARE-0708765	1/2" Wire/Tube P Clamp W/Vinyl Cushion
4	HARDWARE-33078	1/4" SAE Zinc Flat Washer
2	HARDWARE-15003	1/4"-20 X 3/4" Yellow Zinc Finish SAE Grade 8 Hex Cap Screw
2	HARDWARE-37260	1/4"-20 Grade C Lock Nut

**PARTS LIST FOR SKU: HP9219**

QTY	PART #	DESCRIPTION
4	HARDWARE-15157	7/16"-14 X 1.25" Grade 8 Yellow Zinc Hex Cap Screw
4	HARDWARE-37266	7/16"-14 Grade C Lock Nut
8	HARDWARE-33084	7/16" SAE Zinc Flat Washer
6	HARDWARE-63124	6" Black Cable Ties

**PARTS LIST FOR SKU: HP9245**

QTY	PART #	DESCRIPTION
1	6223	FSD Steering Stabilizer Adaptor
1	HARDWARE-M12x1.25x60-FB	M12x1.25x60mm JIS Hex Flange Bolt
1	HARDWARE-M12-FLATWASHER	M12 DIN125 Zinc Flat Washer
1	HARDWARE-M12x1.25-FN	M12-1.25 Hex Flange Nut
1	HARDWARE-18912	1/2"-20x1.5 YZ8 Hex Head Cap Screw
1	HARDWARE-33086	1/2" SAE Zinc Flat Washer
1	HARDWARE-33626	1/2" Zinc Split Washer
1	HARDWARE-UBOLT-3/8-16x1-1/4	U-Bolt Zinc-Plated Steel, 3/8"
2	HARDWARE-33082	3/8" SAE Zinc Flat Washer
2	HARDWARE-37264	3/8"-16 Grade C Lock Nut

**PARTS LIST FOR SKU: HP9276**

QTY	PART #	DESCRIPTION
2	HARDWARE-M8X1.25X30	M8X1.25 30mm Long Hex Cap Screw
4	HARDWARE-33080	5/16" SAE Zinc Flat Washer
2	HARDWARE-M8X1.25-FN	M8 - 1.25 Zinc Hex Flange Nut Nyloc
2	2487	FSD Bump Stop Clocking Tab



## REQUIREMENTS

- Installation requires a qualified mechanic.
- Follow the OE specifications when replacing or re-installing OE fasteners, retainers, and hardware specified in the OEM manual.
- Always wear safety glasses when using power tools.
- When a lift is required to perform the installation of these products and always ensure the vehicle is properly supported before attempting installation or serious injury may occur.

## TECH NOTES

- Read instructions carefully and study the pictures (if included) before attempting installation.
- If this product was purchased as part of a kit each kit, and options to kits, are packaged separately. Therefore installation procedures are covered in separate instructions. Familiarize yourself with each specific set of instructions before beginning.
- Check the parts and hardware packages against the parts list to assure that your kit is complete before starting.
- Tools: (if known)

## INTRODUCTION

Cognito 6" Component Box for 2017-2020 Ford F250/F350 4WD Super Duty Trucks. This component box consists of the front suspension, sway bar, and drive train components needed to install a Cognito 6" Lift. This component box is designed to be used with multiple Cognito rear lift packages and options. All provided steel brackets are finished in semi-gloss black powder coating.

**INSTALLATION**

1. Before starting, secure the rear tires to prevent vehicle from rolling or moving, but do not lift at this time. With the vehicle remaining on the ground, disconnect the front flexible brake lines. Avoid spilling fluid or allowing fluid to come into contact with skin.

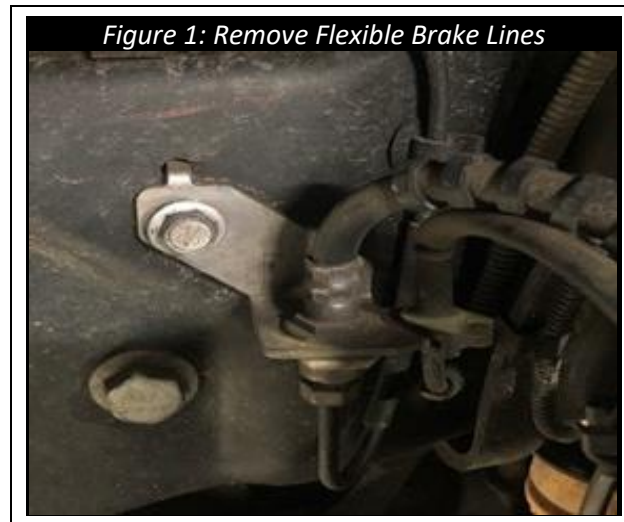

2. If equipped with front or rear sway-bars remove the sway-bar end links (Figure 2/3).

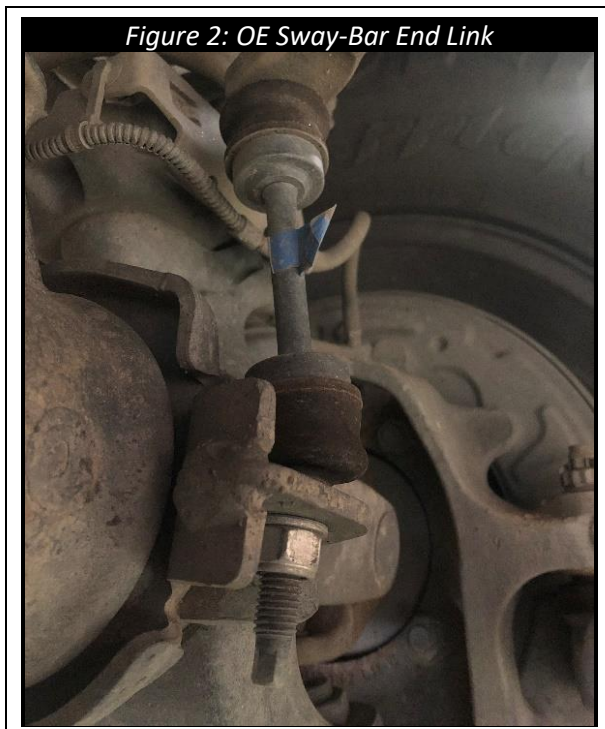

3. Remove the front shocks from both driver and passenger side of the vehicle (Figure 4/5).

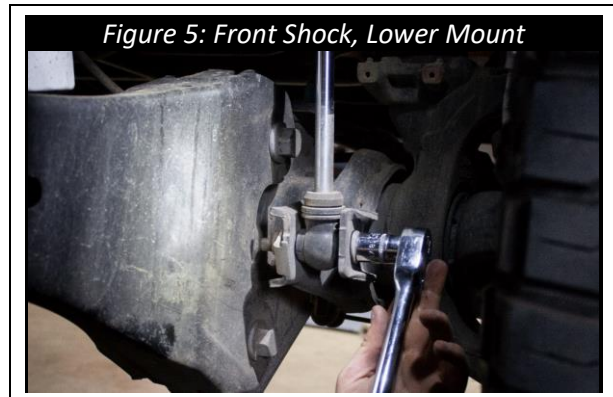
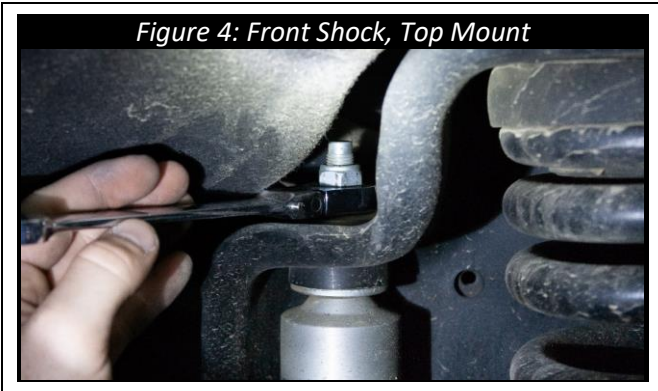

4. Remove the steering stabilizer from the frame mount, located on the passenger side frame rail (Figure 6/7) and from the steering link pivot (Figure 8/9).

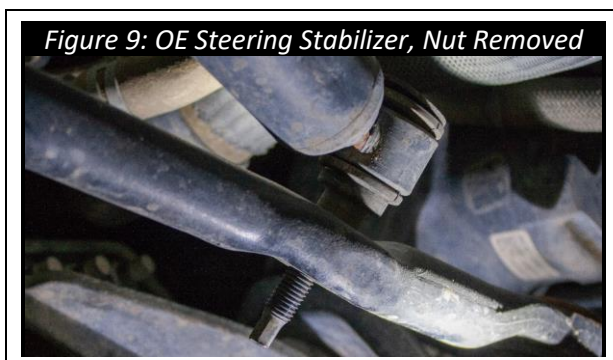

5. Once the nut has been removed from the stabilizer pin, use a hammer to hit the bottom side of the steering link (Figure 10) to break the taper seat loose from stabilizer pin, then remove (Figure 11).



6. Locate the OE track bar mount location under the driver side frame rail (Figure 12). Remove the track bar mounting bolt and rotate the track bar down to remove from the frame mount (Figure 13).

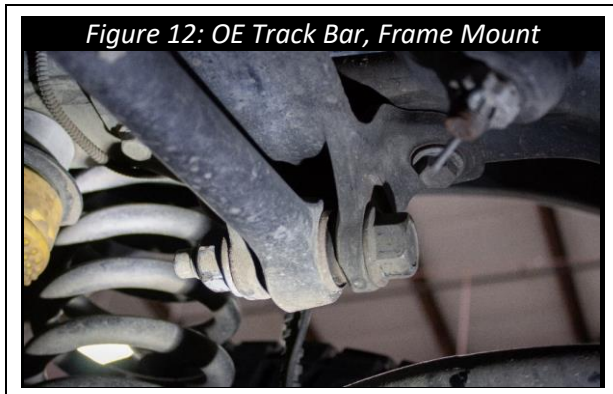

7. Locate the steering link and pitman arm pivot and remove the cotter pin and locking retainer to expose the nut (Figure 14/15). Loosen the nut, but do not remove. Hit the side of the pitman arm with a hammer (Figure 16) to break the taper seat loose from steering link pin, then remove the nut and remove steering link (Figure 17).

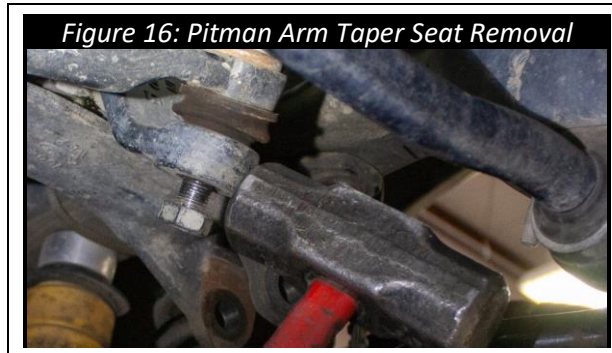
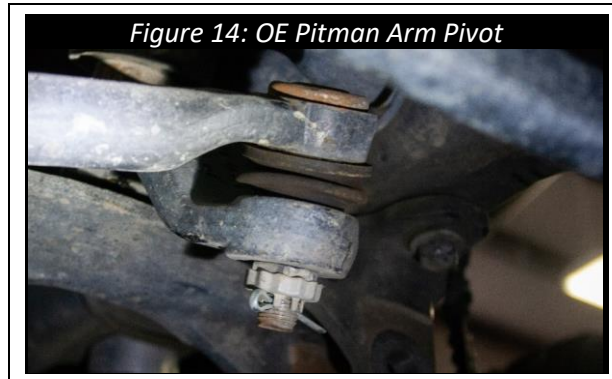

8. Locate the track-bar frame mounting bracket bolts on the driver side frame rail and front cross-member (Figure 18/19) and remove (Figure 20).

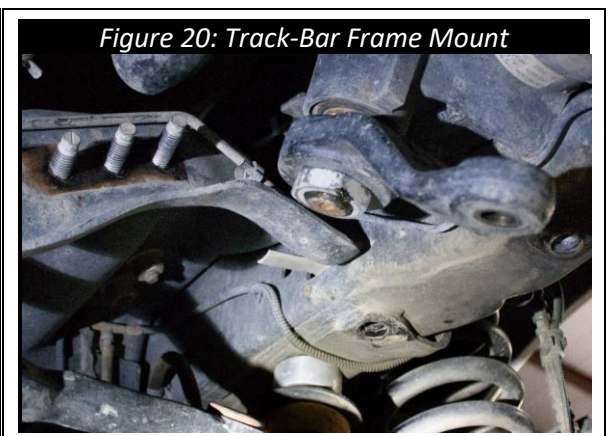
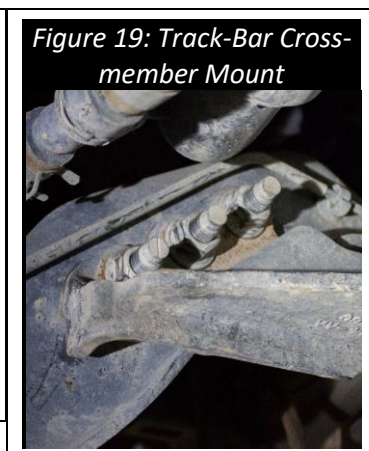
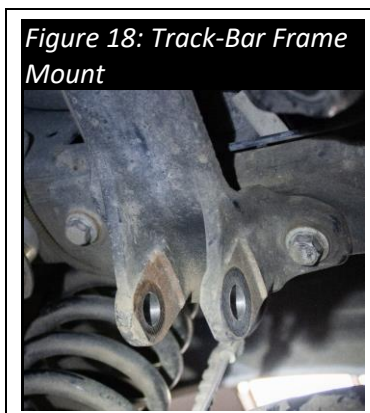

9. Once the track-bar mounting bracket has been removed, loosen and remove the pitman arm nut at the steering box pivot (Figure 21). Use a 2-jaw puller to remove the pitman arm from the steering box (Figure 22).

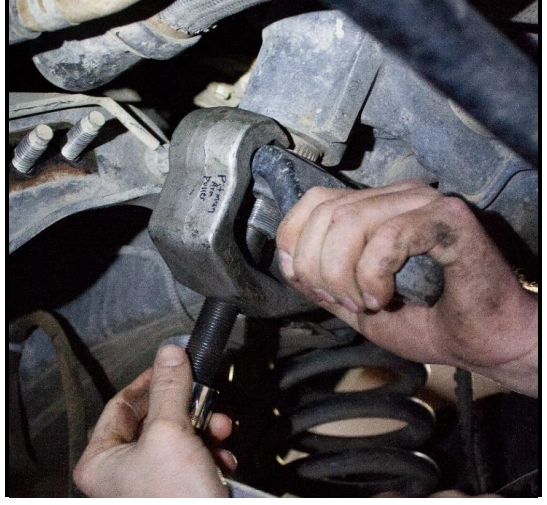
*Figure 21: Steering Box Nut Removed**Figure 22: Pitman Arm Removal*

10. Locate the **Cognito 4" drop pitman arm**, align the new pitman arm at the same orientation as OE by aligning the locating splines (Figure 23). Re-Install the OE pitman arm nut and torque to 250 ft.-lbs. (Figure 24).

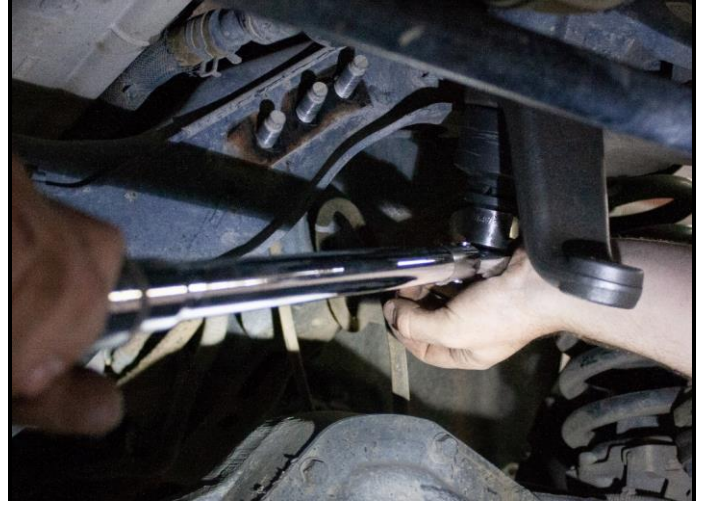
*Figure 23: Pitman Arm Alignment**Figure 24: Torque Pitman Arm*



11. Locate **8547** Cognito track-bar bracket and install using the (2) OE bolts and (3) OE nuts previously removed in step 8. Torque the (2) frame mount bolts and (3) cross-member nuts to 129 ft.-lbs. (Figure 26).

Figure 25: Cognito Track Bar Bracket



Figure 26: Cognito Track-Bar Bracket Installed



12. Remove the (2) bolts mounting the OE steering stabilizer frame mount, located on the passenger side frame rail (Figure 27/28).

Figure 27: OE Steering Stabilizer Frame Mount



Figure 28: Stabilizer Bracket Removed



13. Locate **8544** Cognito steering stabilizer frame bracket and install using the (2) OE bolts removed from step 12, (Figure 29/30) and torque to 52 ft.-lbs.



14. Locate the drag link adjuster, located on passenger side of drag link, and loosen the (2) adjuster clamping bolts and (1) adjuster lock nut (Figure 32). Then slide the adjuster lock away from the adjuster.



**15.** Rotate the drag link so the drag link can be mounted to bottom face of pitman arm (Figure 33). Tighten the drag link nut to 129 ft.-lbs. Re-install the OE lock retainer and cotter pin, removed in step 7, and deform tang to lock nut in place (Figure 34)

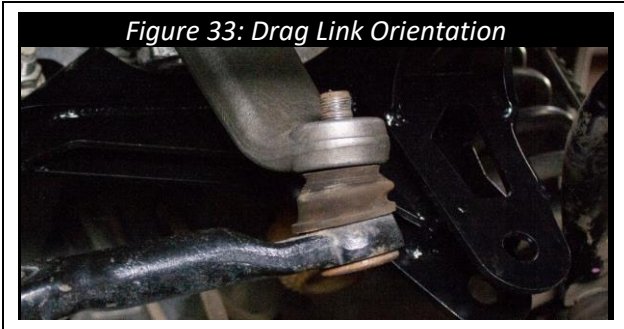

**16.** Locate the items listed below:

- (1) – FSD Steering Stabilizer Adapter (Part # 8544) (Figure 35)
- (1) – HARDWARE UBOLT-3/8-16x1-1/4 (HARDWARE-UBOLT-3/8-16x1-1/4)
- (2) – 3/8 Sae F/W Z (HARDWARE-33082)
- (2) – 3/8-16 Lock Nut Gr C (HARDWARE-37264)
- (1) – FSD Steering Stabilizer Adapter Nut (Part # 6223) (Figure 37)
- (1) – 1/2"-20 UNF x 1.50 Lg. Cap Screw (HARDWARE-18912)
- (1) – 1/2" SAE Flat Washer (HARDWARE-33086)
- (1) – 1/2" Split Washer (HARDWARE-33626)

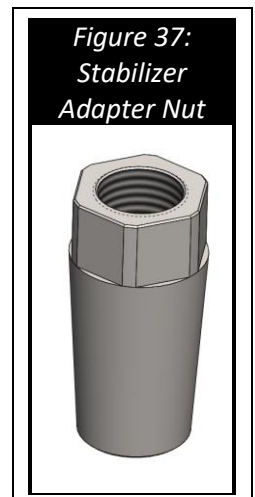

17. Install the tapered steering stabilizer adapter bolt into the bottom of the steering link. Attach the mount as shown in Figure 36 using the 1/2-20 bolt, u bolt, split washers, and flat washers. Tighten 1/2-20 bolt to 100 Ft-lbs. and U bolt nuts to 23 Ft-lbs.
18. Use the (1) M12 x 1.25 x 60mm Lg. and (1) M12x1.25 flange nut to install the OE stabilizer to the Cognito stabilizer bracket, installed in step 13, and torque to 75 ft.-Lbs. (Figure 38/39).



19. Tighten the bolt connecting the steering stabilizer to the adapter bracket to 66 ft.-lbs.

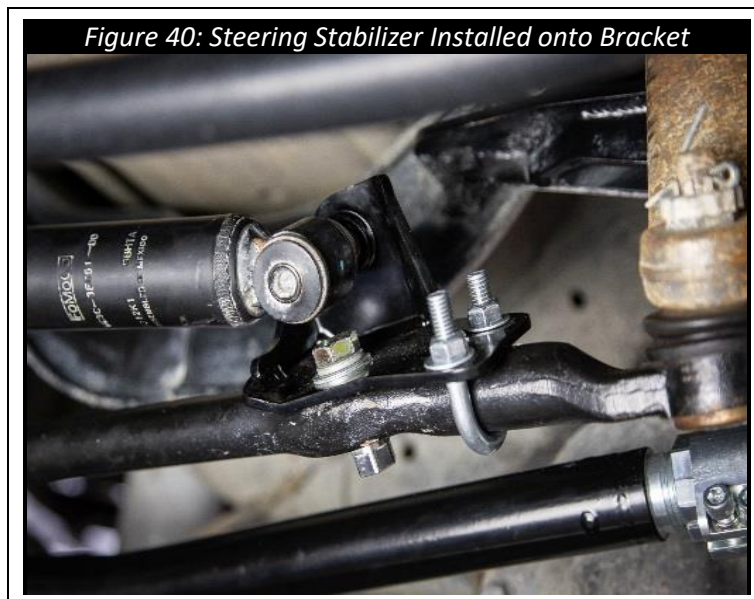

- 20.** Check to ensure that all brake lines, vacuum lines, hoses, and wiring are free to lift vehicle and will not be pulled when vehicle is raised. Raise the vehicle slowly until the front spring preload is removed (Figure 41). **DO NOT** raise the vehicle any higher than necessary to remove springs. This could result in driveline, wiring, brake line, and suspension component damage. Remove front springs and rubber isolator from the driver and passenger side spring perch (Figure 42).



- 21.** Once the front springs are removed, follow the instructions included with the Cognito 4" Radius Arm Drop Bracket Kit (SKU: [120-70088](#)), (Install Sheet 7167)
- 22.** Now follow the instructions included with the Cognito Caster Adjustable Radius Arm Kit (SKU: [120-90408](#)), (Install Sheet, 7153)
- 23.** Locate the OE bump stop underneath both driver and passenger side frame rails. Remove the bump stop using a screwdriver to pry out of the bump stop mount (Figure 43). Once the bump stop is removed, loosen the bolt and remove OE bump stop mount from the frame rail (Figure 44).

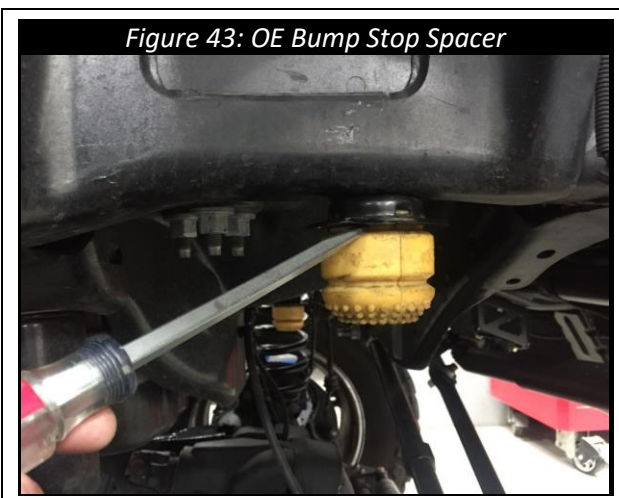

**24.** Locate the items listed below from **HP9276** (Figure 24A):

- (2) – 4.5” FSD Bump Stop Spacer (Part # 8562)
- (2) – M8x1.25x30mm Lg. Cap Screw
- (2) – M8x1.25 Nyloc Flange Nuts
- (4) – 5/16” SAE Flat Washer
- (2) – 2487 Clocking Tabs

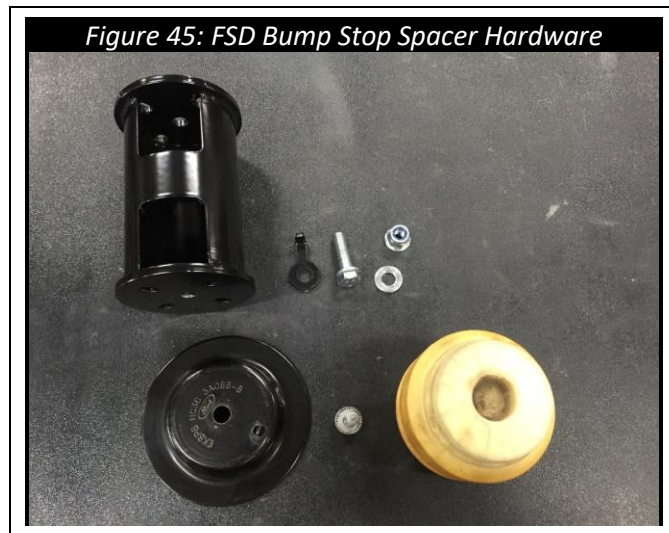

25. Insert the locking tab on the OE bump stop mount into the alignment hole on the bump stop spacer (Figure 46). Using (1) M8x1.25x30mm Lg. cap screw, assemble with (1) M8 x 1.25 nyloc flange nuts and (2) 5/16" SAE flat washers. Torque to 24 ft.-lbs. Then insert the factory hardware into the clocking tab as shown (Figure 47). Insert this into the bump stop so that the clocking tab protrudes through the hole (Figure 48), then reinstall onto the frame. (Figure 49). Torque to 24 ft.-lbs.

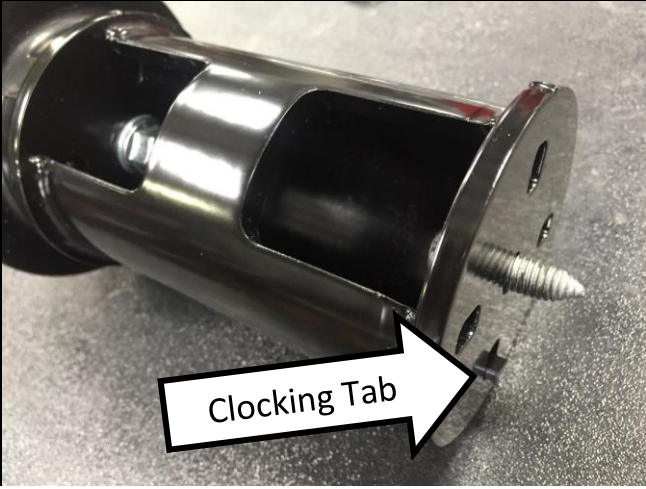
*Figure 46: Bump Stop Spacer Assembled**Figure 47: Bump Stop Spacer Orientation**Figure 48: Bump Stop Spacer Assembled**Figure 49: Bump Stop Spacer Assembled*

26. Repeat steps 23 – 25 for the opposing side bump stop and spacer.
27. If your model of truck is not equipped with a two-piece driveshaft, proceed to step 31. If your truck is equipped with a two-piece driveshaft, locate the carrier bearing spacer (Figure 50).

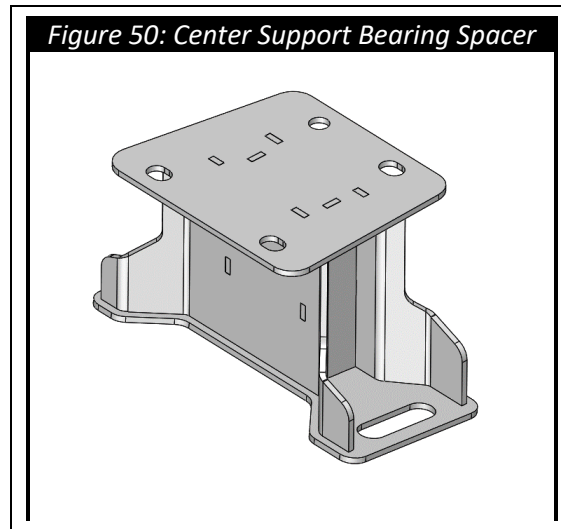

28. Ensure that the center support bearing spacer is oriented correctly in the vehicle!

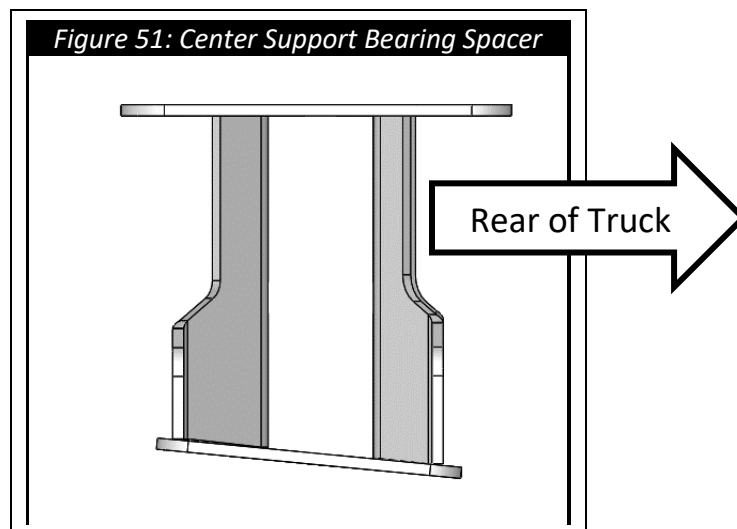



- 29.** Remove the (2) OE carrier bearing mounting bolts, make sure the drive shaft is properly supported during this to prevent drive line damage (Figure 52). Then remove the bolts holding the OEM carrier bearing bracket onto the body. Replace this OEM bracket with the included bracket, ensuring the new bracket slopes up towards the front of the truck. Reinstall the OEM hardware which holds the carrier bearing to the bracket and the bracket to the body. Torque hardware to 52 ft.-lbs.

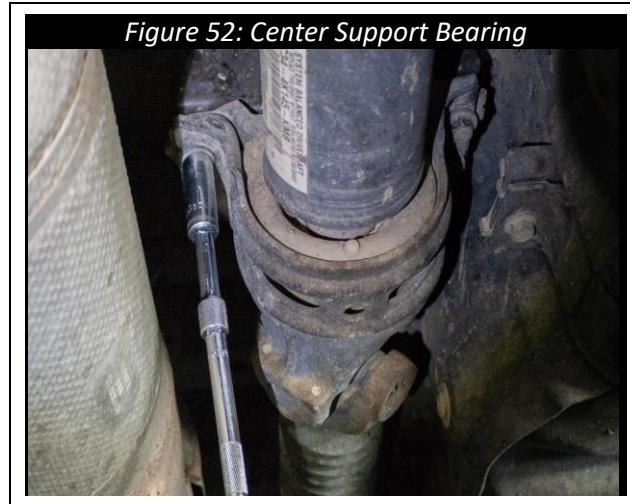

- 30.** Before starting step 30, if using remote reservoir front shocks, refer to those instructions, since the reservoir mount will need to be installed before proceeding further with these instructions. Locate the Cognito coil spring and align the OE rubber isolator, removed in step 21, with the top spring pig-tail (Figure 53). Install the spring with isolator onto the lower spring perch and rotate until the bottom spring pig-tail makes contact with OE spring perch tab (Figure 54). Repeat for the opposing side of vehicle front spring. This will require lifting the vehicle further. Ensure no wires or hoses will be stretched!

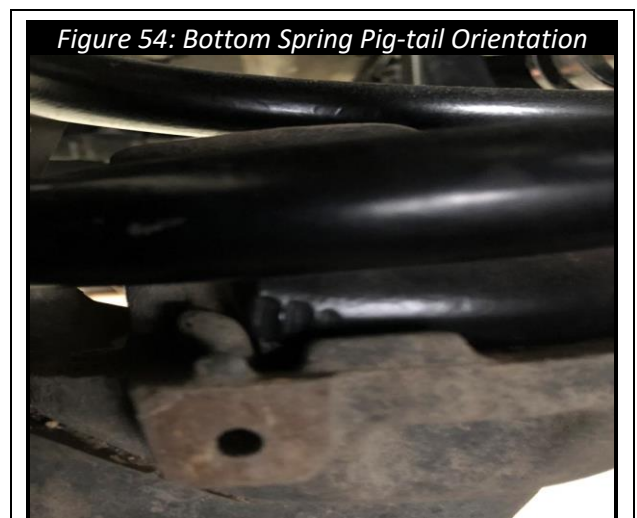
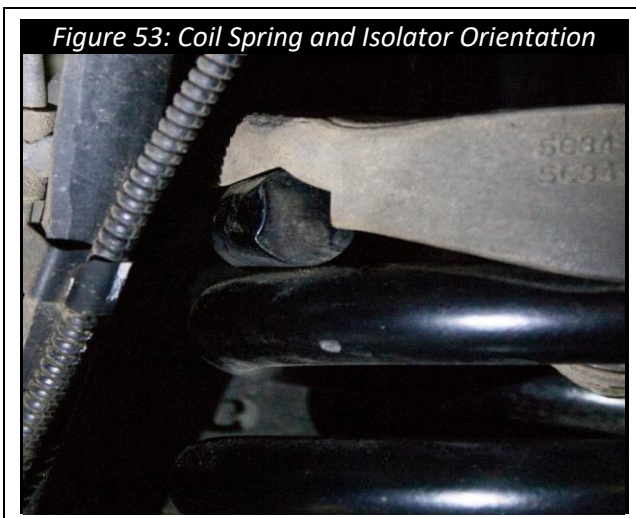

- 31.** Once the springs are installed, locate the Cognito/FOX extended length front shocks. Remove the top washer (Figure 55) and bushing, then insert the top shock mounting stud through the frame, making sure the polyurethane pancake bushings are in place on both sides of frame. Install the top mounting washer with the concave side against bushing (Figure 56). Repeat for the opposing side front shock, but do not tighten at this time.

*Figure 55: Concave Shock Mounting Washer*



*Figure 56: Top Shock Mount Installed*



- 32.** Before starting step 32, it is recommended to get another person to assist during this step. Align both front shock bottom eyelets into lower shock mount shackle. Slowly lower the vehicle until the lower shock eyelets are aligned with the shackle mounting hole (Figure 57). Re-install the OE bolt and locking nut plate, then torque the lower nuts to 66 ft.-lbs. and the upper nuts to 52 ft.-lbs. (Figure 58).

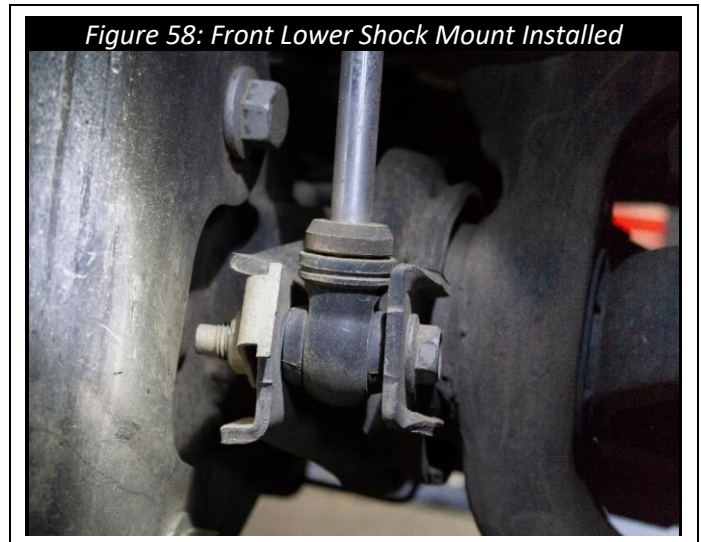
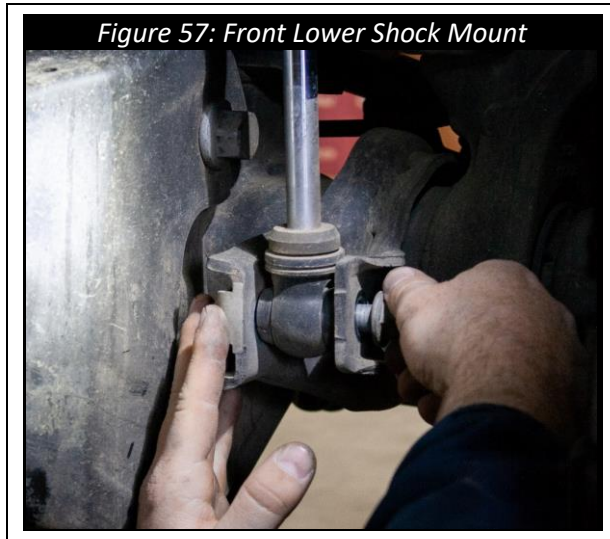

- 33.** Locate the driver side ABS line mounted on the driver side radius arm (Figure 59). Use the 6" black cable ties to attach the ABS line to the front axle vent. Make sure the line is secure in an orientation that avoids interference with the driver side bump-stop pad through full suspension travel (Figure 60/61).

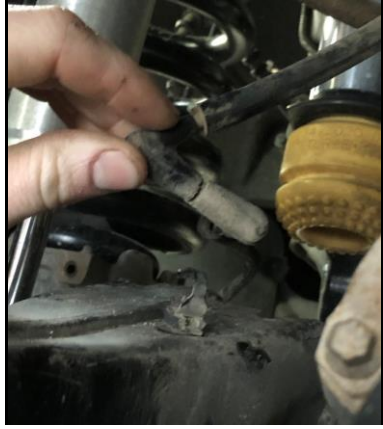
*Figure 59: Driver Side ABS Line**Figure 60: ABS Line Installed**Figure 61: ABS Line Routing*

- 34.** Locate the passenger side ABS line mounted to the front side of the front cross-member (Figure 62). Remove the OE plastic retainer, then use the supplied zip-ties to secure the ABS line in an orientation to prevent any chaffing or wear (Figure 63).

*Figure 62: Passenger ABS Line Location**Figure 63: Passenger ABS Line Routing*

35. Slowly lower the truck down to static ride height.
36. Follow the installation instructions included with the Cognito Adjustable Track Bar at this time.
37. Locate the components listed below (Figure 64/65):
- (1) – 2011-2019 Ford F250/F350 Sway Bar Spacer (Part # 8313)
  - (1) – 2011-2019 Ford F250/F350 Sway Bar Spacer (Part # 8582)
  - (4) – 7/16" -14 X 1 1/4" Cap Screw (HARDWARE-15157)
  - (8) – 7/16" SAE Flat Washers (HARDWARE-33084)
  - (4) – 7/16-14 Lock Nut (HARDWARE-37266)



38. Locate the OE sway bar mounts on both driver and passenger side frame rails (Figure 66). Remove the (2) sway bar mounting bolts from each sway bar mount on both sides of the vehicle (Figure 67).

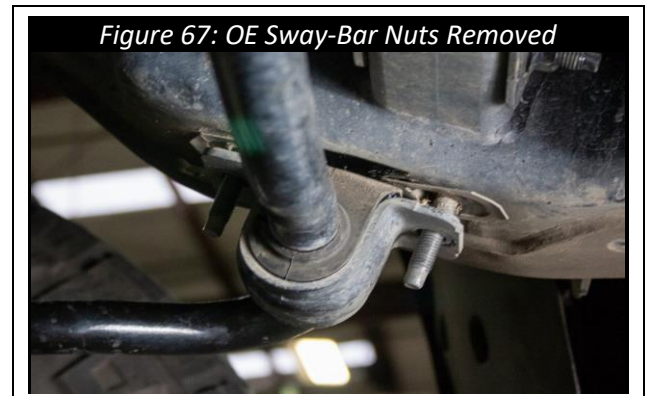
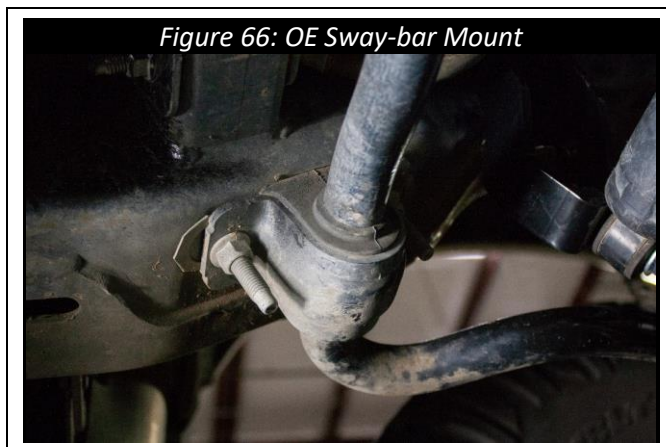

- 39.** Install the Cognito sway-bar spacer brackets in place on both sides of the vehicle. The “open” side of the bracket faces in. Assemble using the OE nuts previously removed, but do not tighten at this time (Figure 68). Then fasten the OE sway-bar mounts on both sides of the vehicle to the Cognito spacer brackets using the (4) 7/16”-14 cap screws with (1) SAE 7/16” washer between the bolt head and bracket and (1) washer between nut and sway-bar mount. Once all the hardware is installed, tighten the OE sway-bar frame mounting nuts to the OE torque specification 35 ft.-lbs. Now tighten the (4) 7/16”-14 cap screws to 70 ft.-lbs. (Figure 69). Finally, install the included extended sway bar end links and tighten the hardware to 90 ft.-lbs.

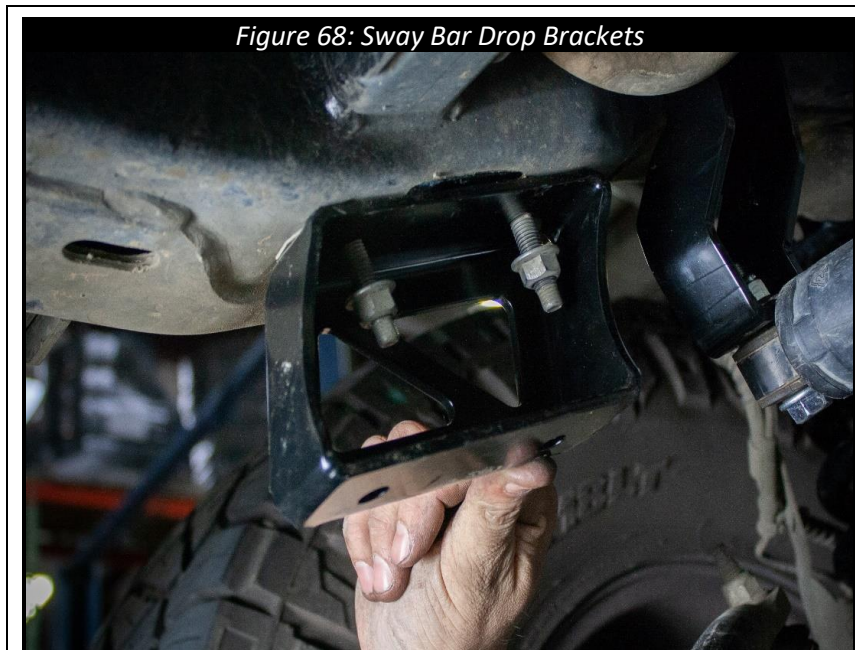

40. Connect the extended brake lines between the factory hard brake lines and the brake calipers. Attach the brake lines to the axle as shown in Figure 70/71. Bleed brakes.

*Figure 70: Brake Line Routing (Passenger Side Shown from Front)*

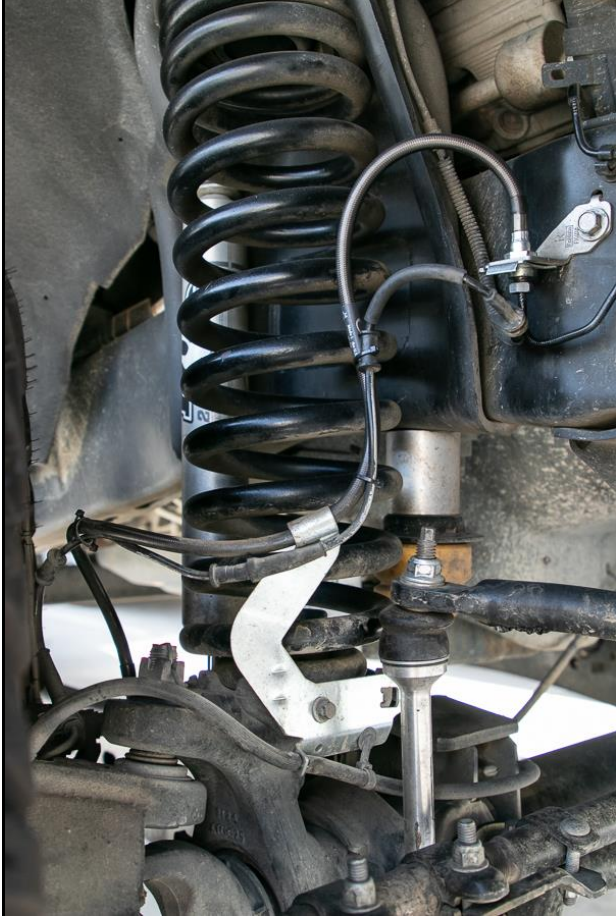

*Figure 71: Brake Line Routing (Passenger Side Shown from Rear)*

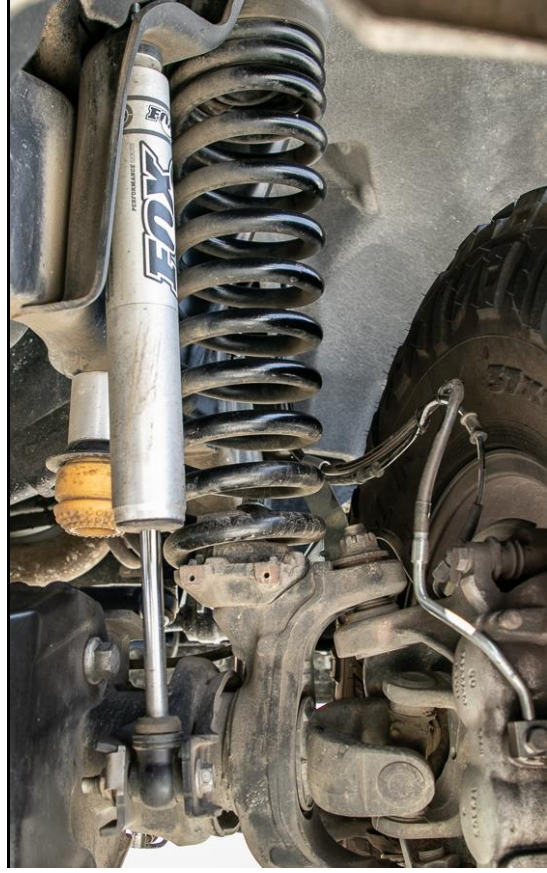

- 41.** Before starting step 41, make sure that all mounting hardware and fasteners are tight in case something was missed. The only item that should remain loose is the steering link adjuster, loosened during step 14. Move the vehicle forwards and backwards a few feet to settle the suspension.
- 42.** Make sure the vehicle is in park with the emergency brake activated, and the engine running. Rotate the drag link adjuster in the appropriate direction to center the steering wheel (Figure 72). Once the steering wheel is in the proper location, rotate the adjuster clamp independently of the adjuster so that it faces the front of the vehicle, then tighten the (2) adjuster clamp bolts to the OE torque specification which is 41 ft.-lbs. Then slide the adjuster lock into position and tighten the (1) locking nut to the OE torque 41 ft.-lbs. (Figure 73).

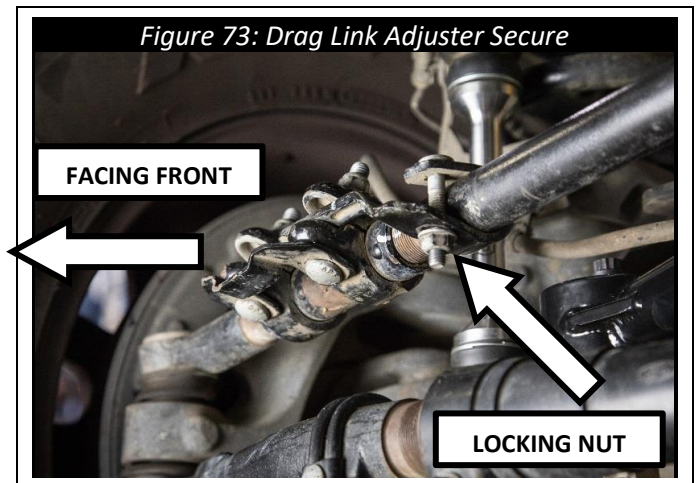
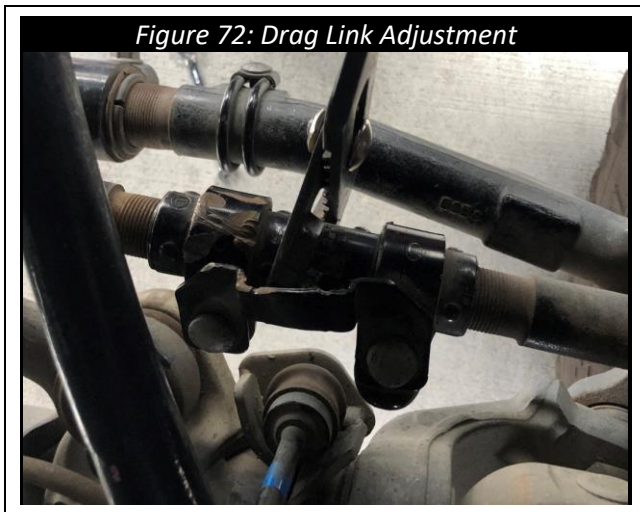

- 43.** Although the steering wheel is now straight, the vehicle may still need a proper professional alignment.

- 44.** Locate the following parts from **HP9218**.

- (1) – FSD E-BRAKE CABLE BRACKET (Part #2524)
- (4) – 1/4" SAE Flat Washer (Part # 33078)
- (2) – 1/2" Wire/Tube P Clamp W/Vinyl Cushion (HARDWARE-0708765)
- (2) – 1/4"-20 X 3/4" Yellow Zinc Finish Grade 8 Hex Cap Screw
- (2) – 1/4-20 Lock Nut (HARDWARE-37260)



45. The OEM E-brake cables are shown in Figure 74, remove them from the OEM bracket and attach to the relocation bracket as shown in Figure 75. Attach the relocation bracket to the frame using the original hardware as shown in Figure 76.

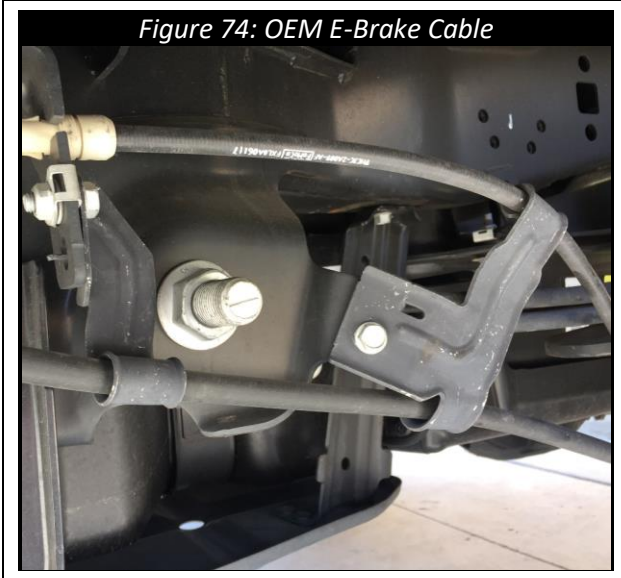

*Figure 74: OEM E-Brake Cable*

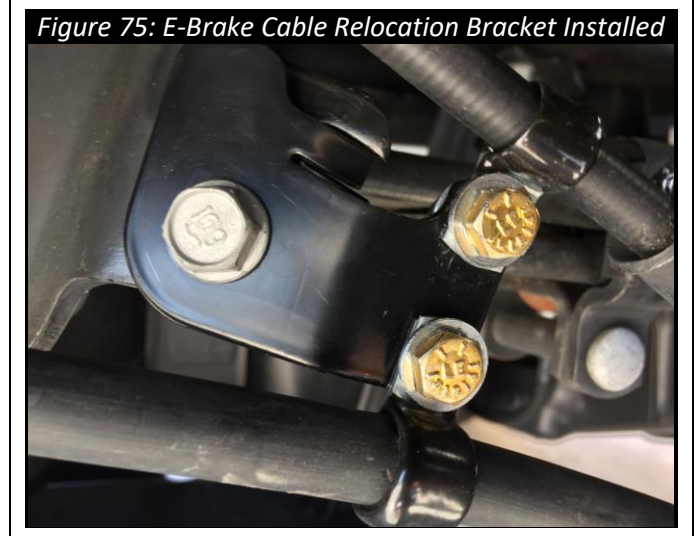

*Figure 75: E-Brake Cable Relocation Bracket Installed*

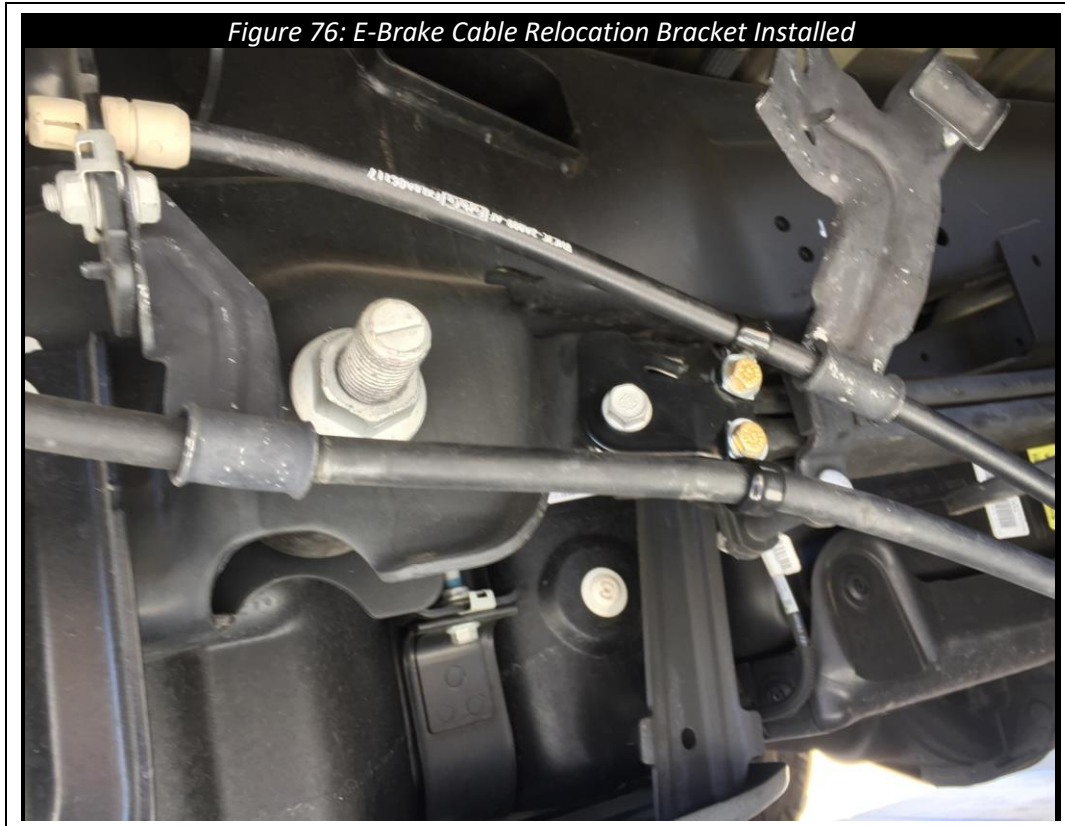

*Figure 76: E-Brake Cable Relocation Bracket Installed*

46. Locate **120-70095** and **BRAKELINE-1032**. Remove the OEM brake line hardware and install the provided brake line hardware at this time.
47. Disconnect the rear shocks from the rear axle and from the frame.
48. Raise the rear end of the truck until the wheels are just off the ground.
49. Undo the nuts and U-bolts holding the rear axle to the leaf springs.
50. Raise the rear end of the truck just enough to install the rear blocks (and mini-packs if applicable).
51. The blocks available for these trucks are slightly tapered when viewed from the side, which is very important to maintain the pinion angle of the diff. Install the rear blocks with the bump stop pad facing inwards and the small end of the taper facing the front of the truck.
52. If installing a mini-pack, install it above the block now. The overload spring (if present) will need to be removed. To do this, use a c-clamp to hold the leaf spring together while removing the stock leaf spring pin. Then carefully remove tension from the C clamp and remove the stock overload spring. Install the mini-pack and align using the included pin. Use the c-clamp to compress the springs together, then tighten the nut holding the entire spring assembly together to 45 Ft-lbs.





53. Install the rear U-bolts and nuts, apply anti-sieze to the u bolt threads. Ensure that the U-bolts are tightened evenly, so that the same amount of thread is showing. Torque in an “x” pattern in four stages, first to 48 Ft-lbs., then 96 Ft-lbs., and finally 130 Ft-lbs.
54. Install the new rear shocks. Tighten upper hardware to 52 Ft-lbs. and lower hardware to 66 Ft-lbs.
55. Add gear oil to the front and rear diffs until the level reaches the fill port.
56. If equipped with a rear sway bar, assemble and install the rear sway bar end links, part **8817**, using the hardware from **HP9051**. Lubricate the outside of the hourglass bushings with WD40, then press them into the end link. Next, grease the outside of the crush sleeve and press into the hourglass bushing. Use the longer bolts on the bottom of the end link. Tighten hardware to 75 Ft-lbs.



## WARRANTY / RETURN POLICY / SAFETY

### **Cognito Limited Lifetime Warranty**

Cognito Motorsports, Inc. hereinafter “Cognito,” warrants to the original retail purchaser, that its suspension products are free from workmanship and material defects for as long as the purchaser owns the vehicle on which the product(s) were originally installed. This warranty will be void if any modifications are made to the components, including alterations to the surface finish, i.e.; painting, powder coating, plating, and/or welding, or if they are improperly installed. Cognito truck suspension products are not designed nor intended to be installed on “competition” vehicles used in race applications, stunt or for exhibition purposes that are outside of the intended operating conditions specified by the manufacturer. Racing and competition are defined as any contests between two or more vehicles; or vehicles competing individually on off road circuits in timed events (whether or not such contests are for an award or prize).

This warranty does not include coverage for police, taxi, government or commercial vehicles, and the warranty does not cover Cognito products sold outside of the USA. Cognito’s obligations under this warranty are specified and applied at its sole discretion, and warranty coverage is limited to repair or replacement of the defective product(s). Any and all costs of removal, installation or reinstallation; freight charges, incidental or consequential damages associated with the covered products are expressly excluded from this warranty.

The following items are exempt from Cognito limited warranty coverage: bushings, bump stops, tie-rod ends (Heim joints) and limiting straps. These parts are “consumables” and designed to wear as a normal part of their duty cycle, therefore they are not considered defective when worn. The aforementioned products are warrantied separately against defects in workmanship, for 60 days from the date of purchase. As a condition of warranty validation, respective Cognito suspension components must be installed as a complete system (not combined with non-Cognito hardware or ancillary parts). Any substitutions or omission of required components will void the warranty. Some minor cosmetic wear and imperfections may occur to parts during shipping, which is not covered under this warranty. This limited warranty does not apply to any components that have been subjected to collision damage, negligence, alteration, abuse, or misuse, and coverage does not extend to products manufactured by third-party companies. Cognito reserves the right to supersede, discontinue, or change the design, finish, part number and/or application of its parts when deemed necessary, without notice.

### **Return Policy**

Product returns will not be accepted without prior written approval from an authorized Cognito representative. All products being returned must be shipped via trackable, prepaid freight. Returned products are subject to a 25% percent restocking fee. The eligible return period for products purchased directly from Cognito is 30 days from the verified date when the product(s) were originally received by the purchaser.

### **Product Safety Advisory**

The installation of Cognito steering and suspension components will modify your vehicle’s original factory equipment and geometry, which may cause it to handle differently than a stock (unaltered) vehicle. Installation of these components is not intended to strengthen nor reinforce the vehicle’s frame, nor are they designed to increase rollover protection. It is necessary to periodically inspect all suspension and drive train components for proper attachment, torque specifications, operation, and for any potential unusual wear or damage. Installation of these parts will modify the height of the vehicle and may raise the center of gravity. Modifying vehicle height combined with off road operation may increase your vehicle’s susceptibility to rollover conditions, which may cause serious injury or death. Many states regulate allowable vehicle height modifications, and it is your responsibility to know and comply with the legal requirements specified by the laws where you reside. Modifications to your vehicle’s ride height may also affect the ride quality, driver input response, trackability and handling, and wear to your vehicle’s suspension components and tires.



Revision Table			
Rev	Description	Date	Approved
NC	BASED ON 8132	7/22/2022	DJ
A	UPDATED 8817	9/8/2022	SB